

**CITY OF FORT BRAGG**  
**COMMUNITY DEVELOPMENT DEPARTMENT**  
 416 North Franklin Street  
 Fort Bragg, CA 95437  
 Tel: (707) 961-2827  
 Fax: (707) 961-2802  
 http://city.fortbragg.com



Case No(s) \_\_\_\_\_  
 Date Filed \_\_\_\_\_  
 Fee \_\_\_\_\_  
 Receipt No. \_\_\_\_\_  
 Received by \_\_\_\_\_

*Office Use Only – December 2011*

## PLANNING APPLICATION FORM

Please complete this application thoroughly and accurately, and attach the required exhibits as indicated in the applicable brochure available from the Community Development Department. An incomplete application will not be accepted for processing. Please note that administrative permits may require additional fees if an interested party requests a public hearing. Public hearing expenses are borne by the applicant, owner, or agent.

### APPLICANT

Name: Robert Pinoli, Mendocino Railway  
 Mailing Address: 100 West Laurel St Phone: (707) 964-6371  
 City: Fort Bragg State: CA Zip Code: 97214 Email: \_\_\_\_\_

### PROPERTY OWNER

Name: Mendocino Railway  
 Mailing Address: 100 West Laurel St Phone: (707) 964-6371  
 City: Fort Bragg State: CA Zip Code: 97214 Email: \_\_\_\_\_

### AGENT

Name: Jeremie Maehr, Kennedy Jenks  
 Mailing Address: 1676 N. California Blvd. Suite 430 Phone: (415) 243-2472  
 City: Walnut Creek State: CA Zip Code: 94596 Email: JeremieMaehr@kennedyjenks.com

**STREET ADDRESS OF PROJECT** 90 W. Redwood Ave., Fort Bragg, CA 95437

**ASSESSOR'S PARCEL NUMBER(S)** 0080201900

**PROPERTY SIZE** \_\_\_\_\_ Square Feet **or** 85 \_\_\_\_\_ Acres

### TYPE OF APPLICATION (Check all applicable boxes)

- |  |  |
|--|--|
| <input type="checkbox"/> Design Review/Site & Architectural Review | <input type="checkbox"/> Certificate of Compliance             |
| <input type="checkbox"/> Use Permit/Minor Use Permit               | <input type="checkbox"/> General Plan Amendment                |
| <input checked="" type="checkbox"/> Coastal Development Permit     | <input type="checkbox"/> Local Coastal Program Amendment       |
| <input type="checkbox"/> Variance/Administrative Variance          | <input type="checkbox"/> Rezoning                              |
| <input type="checkbox"/> Lot Line Adjustment                       | <input type="checkbox"/> Annexation                            |
| <input type="checkbox"/> Subdivision (no. of parcels) _____        | <input type="checkbox"/> Preapplication Conference             |
| <input type="checkbox"/> Certificate of Appropriateness (COA)      | <input type="checkbox"/> Limited Term Permit                   |
| <input type="checkbox"/> Planned Development Permit                | <input type="checkbox"/> Permit Amendment (list permits) _____ |

### PROJECT DESCRIPTION (Briefly describe project as shown on proposed plans.)

Proposed project includes improvements to the Mill Pond Dam in response to DSOD requirements and to DTSC requirements for remedial action for contaminated sediment in Pond 8. The proposed project is the culmination of years of coordination between multiple agencies, including DSOD, DTSC, RWQCB, CCC, and the City (previously completed under Georgia-Pacific, LLC ownership, to continue under Mendocino Railway ownership). Three modifications are planned: 1) a rock slope protection (RSP) buttress at the crib wall section; 2) ground improvements and an earth-fill buttress at the eastern dam section; and 3) a cutoff wall installed near the center of the pond to divide into two smaller ponds. See attached Scope of Work summary for additional information.

## CERTIFICATION

I hereby certify that I have read this completed application and that, to the best of my knowledge, the information in this application and all attachments is complete and accurate. I understand that failure to provide requested information or misstatements submitted in support of the application shall be grounds for either refusing to accept the application, for denying the permit, for suspending or revoking a permit issued on the basis of such misrepresentations, or for seeking of such further relief as may seem proper to the City.

  
\_\_\_\_\_  
Signature of Applicant/Agent

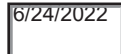
6/24/2022  
\_\_\_\_\_  
Date

  
\_\_\_\_\_  
Signature of Property Owner

6/23/2022  
\_\_\_\_\_  
Date

## INDEMNIFICATION AND HOLD HARMLESS AGREEMENT

ORDINANCE No. 771, adopted by the Fort Bragg City Council on September 26, 1994, requires applicants for discretionary land use approvals to sign the following Indemnification Agreement. Failure to sign this agreement will result in the application being considered incomplete and withheld from further processing.

As part of this application, the applicant agrees to defend, indemnify, release and hold harmless the City of Fort Bragg, its agents, officers, attorneys, employees, boards and commissions, as more particularly set forth in Fort Bragg Municipal Code Chapter 18.77, from any claim, action or proceeding brought against any of the foregoing individuals or entities, the purpose of which is to attach, set aside, void or annul the approval of this application or adoption of the environmental document which accompanies it. The indemnification shall include, but not be limited to, damages, costs, expenses, attorney fees or expert witness fees that may be asserted by any person or entity, including the applicant, arising out of or in connection with the approval of this application, whether or not there is concurrent, passive or active negligence on the part of the City, its agents, officers, attorneys, employees, boards and commissions.

  
\_\_\_\_\_  
Signature of Applicant

6/24/2022

\_\_\_\_\_  
Date

## SITE VIEW AUTHORIZATION

I hereby grant permission for City staff and hearing bodies to enter upon and site view the premises for which this application is made in order to obtain information necessary for the preparation of required reports and render its decision.

  
\_\_\_\_\_  
Property Owner/Authorized Agent

6/24/2022

\_\_\_\_\_  
Date

*NOTE: If signed by agent, owner must sign "Authorization of Agent" below.*

## DECLARATION OF POSTING

At the time the application is submitted for filing, the applicant must complete and post the "Notice of Pending Permit" form at a conspicuous place, easily read by the public and as close as possible to the project site. If the applicant fails to post the completed notice form and sign the Declaration of Posting, the Community Development Department cannot process the application.

I hereby certify that I or my authorized representative posted the "Notice of Pending Permit" form in a conspicuous place, easily seen by the public and as close as possible to the project site for:

Cypress Street Gate

(Describe location where notice is posted)

  
\_\_\_\_\_  
Property Owner/Authorized Agent

6/24/2022

\_\_\_\_\_  
Date

*NOTE: If signed by agent, owner must sign "Authorization of Agent" below.*

## AUTHORIZATION OF AGENT

I hereby authorize Jeremie Maehr to act as my representative and to bind me in all matters concerning this application.

  
\_\_\_\_\_  
Property Owner

6/23/2022

\_\_\_\_\_  
Date



# NOTICE OF PENDING PERMIT

THE CITY OF FORT BRAGG IS PROCESSING AN APPLICATION  
FOR DEVELOPMENT ON THIS SITE

## PROPOSED DEVELOPMENT:

Proposed project includes improvements to the Mill Pond Dam in response to DSOD and DTSC requirements. The proposed project is the culmination of years of coordination between multiple agencies, including DSOD, DTSC, RWQCB, CCC, and the City (previously completed under Georgia-Pacific, LLC ownership, to continue under Mendocino Railway ownership). Three modifications are planned: 1) a rock slope protection (RSP) buttress at the crib wall section; 2) ground improvements and an earth-fill buttress at the eastern dam section; and 3) a cutoff wall installed near the center of the pond to divide into two smaller ponds.

**STREET ADDRESS:** 90 W. Redwood Ave., Fort Bragg, CA 95437

**ASSESSOR PARCEL NUMBER(S):** 0080201900

**APPLICANT'S NAME:** Robert Pinoli

**DATE NOTICE POSTED:**

**For further information, please contact:**

City of Fort Bragg  
Community Development Department  
416 North Franklin Street  
Fort Bragg, CA 95437  
Tel: 707-961-2827

NOTE: At the time an application is submitted for filing, the applicant must complete and post this notice in a conspicuous place, easily read by the public and as close as possible to the project site. A notice of the public hearing will be mailed 10 days prior to the public hearing to property owners within 300 feet of the project site and all other parties requesting notification.

24 June 2022

## Technical Memorandum

To: City of Fort Bragg Community Development Department

From: Jeremie Maehr, Kennedy Jenks

Subject: Scope of Work - Coastal Development Permit Planning Application Form  
Former Georgia-Pacific Wood Products Facility  
90 West Redwood Avenue, Fort Bragg, Mendocino County, California  
KJ 1965021\*21

---

This technical memorandum provides a summary of the scope of work for proposed improvements to address California Division of Safety of Dams (DSOD) requirements at the Mill Pond Dam and Pond 8 (the Mill Pond) at the former Georgia-Pacific Wood Products Facility (site) located at 90 West Redwood Avenue, Fort Bragg, Mendocino County, California. Improvements to the Mill Pond Dam will also provide even more secure containment for sediment, as called for in Mendocino Railway's Draft Operable Unit E Remedial Action Plan (RAP) required by the California Department of Toxic Substances Control (DTSC). See attachment to CDP Application.

The proposed project is the culmination of several years of coordination between multiple agencies, including DSOD, DTSC, Regional Water Quality Control Board (RWQCB), California Coastal Commission, and the City of Fort Bragg (City). Coordination was previously completed under Georgia-Pacific, LLC ownership and will continue under Mendocino Railway ownership. Consistent with discussions among the aforementioned agencies in meetings on-site and at the City and DSOD offices in February and April 2018, proposed construction tasks include the following:

### **1. Construct Rock Slope Protection (RSP) Buttress**

The purpose of the proposed RSP buttress being proposed by Mendocino Railway on the downstream side of the crib wall section of the dam is to improve seismic stability of the portion of the dam, which is currently supported with timber cribbing to the south of and adjacent to the existing spillway. The RSP buttress will also protect the downstream dam slope from wave run-up and surface erosion. The downstream toe of the southern portion of the dam is adjacent to the beach, and will therefore, accommodate tidal changes and other considerations. Additional details regarding construction of the RSP buttress at downstream side of the crib wall section include the following:

- Approximately 1,375 cubic yards (CY) of armor rock and aggregate will be added to the slope.

## Technical Memorandum

City of Fort Bragg Community Development Department

24 June 2022

Project Number 1965021\*21

Page 2

- Construction activities are to remain above mean high tide line (MHTL).
- A temporary ramp is to be installed along the beach berm to access beach during construction.

### **2. Complete Ground Improvements and Construct Earthfill Buttress**

The purpose of the northern dam section modifications being proposed by Mendocino Railway is to improve the seismic stability of the eastern portion of the Mill Pond Dam, also referenced as the north berm, by mitigating the liquefaction hazard identified in the embankment and foundation soils and providing additional buttressing to reduce deformations during strong ground shaking. Additional details regarding ground improvements and construction of an earthfill buttress at the downstream side of the eastern dam section include the following:

- Cement deep soil mixing (CDSM) columns will be installed to improve soil stability. Installation of 2-foot diameter columns, spaced 1.5 feet apart (center to center), and approximately 15 feet to 25 feet deep are assumed. CDSM columns will be installed 1 foot into bedrock.
- Approximately 230 CY of soil will be removed.
- Approximately 1,730 CY of soil and 5,704 CY of rockfill will be added.
- A rockfill workpad will be installed during construction.

### **3. Construct Cutoff Wall**

The purpose of the cutoff wall proposed by Mendocino Railway is to hydraulically divide Pond 8 into two smaller ponds that are operated independently and meet the DSOD criteria for non-jurisdictional dams. Additional details regarding construction of the cutoff wall in the center of Pond 8 include the following:

- Cutoff wall is designed to be approximately 63 feet wide and 21 feet deep. Construction methods and wall design are expected to consist of a combination of precast concrete units, soil fill, and cast-in-place reinforced concrete.
- In the Mill Pond, cattail vegetation, where present in the work footprint, will be cleared prior to start of work and set aside. Removed vegetation will be replaced over the excavation area to aid in revegetation from native seed and root stock.
- Cutoff Wall construction will require either installation of sheet pile walls or temporary excavation of sediment to slope excavation sidewalls to facilitate sediment removal from the cutoff wall footprint. Excavated sediment is expected to be placed in the pond area adjacent to the construction area.

## Technical Memorandum

City of Fort Bragg Community Development Department

24 June 2022

Project Number 1965021\*21

Page 3

### General Notes

- Proposed construction task details are based on 60% Design Drawings (enclosed), a level of design appropriate for agency constructability review, and are subject to DSOD approval.
- Consistent with previous work completed at the site, pond water that is incidentally removed with soil and sediment will be allowed to drain back into the pond.

Further project information is provided in the attached enclosures:

1. 60% Design Drawings for Former Georgia-Pacific Wood Products Facility, Retrofit of Mill Pond Dam (Slate Geotechnical Consultants 2022).
2. Wave Study at Mill Site and Sizing of Primary Layer of Rock Slope Protection (ESA 2017).
3. Draft Remedial Action Plan – Operable Unit E, Former Georgia-Pacific Wood Products Facility Fort Bragg, California (Kennedy Jenks 2020).
4. Operable Unit E Draft Remedial Action Plan and Confirmation of No Further Action for Operable Unit E Soil and Ponds 5 and 9, Former Georgia-Pacific Wood Products Facility, Fort Bragg, California (DTSC 2020).

## Enclosure 1

---

60% Design Drawings for Former Georgia-Pacific Wood Products Facility,  
Retrofit of Mill Pond Dam (Slate Geotechnical Consultants 2022)

# FORMER GEORGIA-PACIFIC WOOD PRODUCTS FACILITY

## PROJECT PLANS FOR RETROFIT OF MILL POND DAM LOCATED AT MILL POND FORT BRAGG, CA

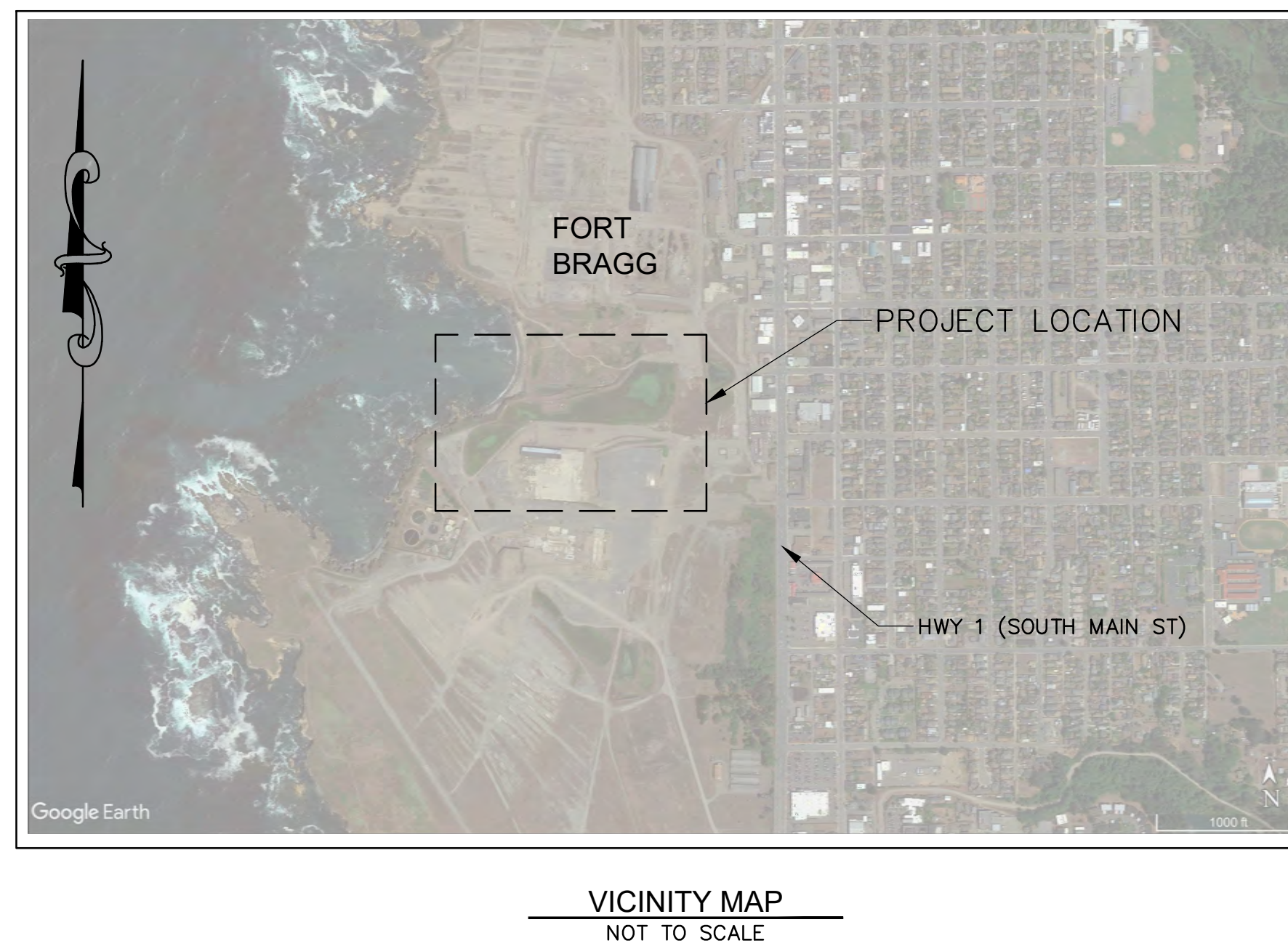
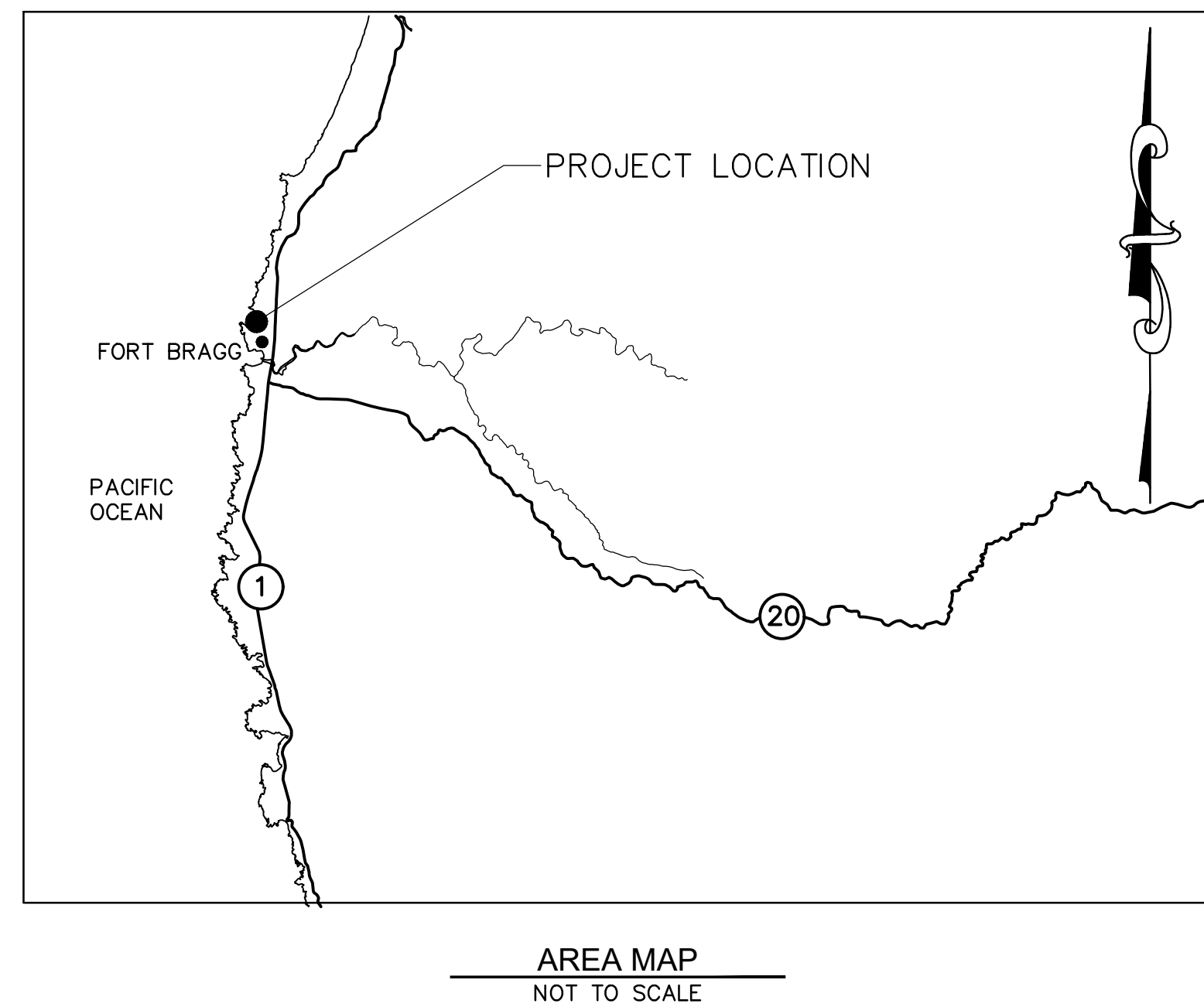

### SHEET INDEX

SHEET NO.	TITLE
1	TITLE SHEET
2	NOTES & ABBREVIATIONS
3	SITE IMPROVEMENT PLAN
4	NORTH DAM IMPROVEMENT WORKING PAD PLAN
5	NORTH DAM IMPROVEMENT CDSM LAYOUT & DETAIL
6	NORTH BUTTRESS IMPROVEMENT PLAN
7	NORTH DAM IMPROVEMENT SECTIONS A & B
8	NORTH DAM IMPROVEMENT SECTION C
9	NORTH DAM IMPROVEMENT SECTION DETAIL
10	GRAVITY WALL PLAN & SECTION
11	SOLDIER PILE WALL DETAILS
12	GRAVITY WALL SECTION
13	SOUTH DAM IMPROVEMENT BUTTRESS LAYOUT
14	SOUTH DAM IMPROVEMENT SECTIONS A & B
15	SOUTH DAM IMPROVEMENT SECTION C

### NOTES:

1. VERTICAL DATUM IS NAV88
2. HORIZONTAL DATUM IS NAD83
3. COORDINATES ARE SHOWN IN CALIFORNIA STATE PLANES, ZONE 2, U.S. SURVEY FEET, (CA83-IIF)

### ABBREVIATIONS

AC	ACRE
BFE	BASE FLOOD ELEVATION
CDSM	CEMENT DEEP SOIL MIXING
CIP	CAST IRON PIPE
CMP	CORRUGATED METAL PIPE
CPT	CONE PENETRATION TESTING
DWL	DESIGN WATER LEVEL
(E)	EXISTING
EL.	ELEVATION
(M)	MODIFIED
MAX	MAXIMUM
MHW	MEAN HIGH WATER
MIN	MINIMUM
NAD83	NORTH AMERICAN DATUM OF 1983
NAV88	NORTH AMERICAN VERTICAL DATUM OF 1988
NIC	NOT IN CONTRACT
RSP	ROCK SLOPE PROTECTION
S.F.	SQUARE FOOT (FEET)
TBD	TO BE DETERMINED
TYP	TYPICAL
WSEL	WATER SURFACE ELEVATION



DESCRIPTION	DATE	BY	REV

CALIFORNIA  
MENDOCINO COUNTY  
FORT BRAGG

TITLE SHEET  
MILL POND DAM

NOT FOR CONSTRUCTION

DATE: 03/29/2022  
SCALE: NTS  
DESIGNED BY: J. LEATHAM  
DRAFTED BY: J. LEATHAM  
CHECKED BY: M. RYAN  
JOB NO.: 22-079-01  
FILE: 17-031.02 TITLE.dwg

1  
SHEET 1 OF 15

60% NOT FOR CONSTRUCTION

PLOT DATE: Tuesday, May 10, 2022 TIME: 10:56:04 AM BY: STEPHANIE GOTTSCH  
FILE: c:\bms\p\00207949\17-031.02 TITLE.dwg





GENERAL NOTES

- ALL WORK SHALL BE IN ACCORDANCE WITH THE CONTRACT DOCUMENTS
- THE NOTES PROVIDED ON THESE DRAWINGS DO NOT REPRESENT A COMPLETE DESCRIPTION OF THE WORK TO BE PERFORMED AND ARE INTENDED TO COMPLEMENT THE SPECIFICATIONS. TECHNICAL SPECIFICATIONS ASSOCIATED WITH THIS WORK ARE AS FOLLOWS:
  - [CALTRANS 2015 STANDARD SPECIFICATIONS SECTION 19 EARTH WORK.
  - CALIFORNIA BANK AND SHORE ROCK SLOPE PROTECTION DESIGN.
- SPECIFICATIONS AND NOTES MAY BE PRESENTED SEPARATELY, BUT SUCH SEPARATION SHALL NOT BE CONSIDERED TO LIMIT THE WORK REQUIRED OF ANY PARTICULAR TRADE.
- THE CONTRACTOR IS RESPONSIBLE FOR ALL CONSTRUCTION MEANS AND METHODS.
- LOCATIONS AND DIMENSIONS OF EXISTING STRUCTURES AND FEATURES HAVE NOT BEEN VERIFIED. THE CONTRACTOR IS RESPONSIBLE FOR VERIFYING ALL CONTROLLING DIMENSIONS OF NEW AND EXISTING FEATURES PRIOR TO ORDERING OR FABRICATING MATERIAL OR CONSTRUCTING PROPOSED IMPROVEMENTS. REPORT ANY DISCREPANCIES TO THE ENGINEER PRIOR TO PROCEEDING WITH CONSTRUCTION OF THE FEATURE IN QUESTION.
- PRIOR TO THE START OF CONSTRUCTION, LOCATE ALL EXISTING AND UNDERGROUND UTILITIES IN AND AROUND THE AREAS OF NEW CONSTRUCTION. VERIFY THAT THE PROPOSED CONSTRUCTION DOES NOT CONFLICT WITH EXISTING OR PROPOSED UTILITIES OR THAT APPROPRIATE MEANS ARE PROVIDED FOR REROUTING, SUPPORTING, PROTECTING, OR OTHERWISE INCORPORATING THE UTILITIES INTO THE CONSTRUCTION.
- NOTIFY THE OWNER AND/OR ENGINEER WHERE A CONFLICT OR DISCREPANCY OCCURS BETWEEN THESE DRAWINGS AND ANY OTHER PORTION OF THE CONTRACT DOCUMENTS OR EXISTING FIELD CONDITIONS.
- PRODUCTS REFERENCED ON THE DRAWINGS SHALL BE CONSTRUCTED, INSTALLED, AND/OR APPLIED IN ACCORDANCE WITH THE MANUFACTURER'S WRITTEN RECOMMENDATIONS UNLESS OTHERWISE NOTED.
- DO NOT SCALE DRAWINGS. CONTACT THE ENGINEER FOR ANY DIMENSIONS OR SPECIFIC DETAIL NOT SHOWN.
- THE CONTRACTOR SHALL BE RESPONSIBLE FOR MAINTAINING RECORDS SUITABLE FOR DEVELOPING "AS-BUILT" DRAWINGS THROUGHOUT THE COURSE OF CONSTRUCTION, INCLUDING, BUT NOT LIMITED TO, THE LOCATIONS AND GRADES OF ALL UNDERGROUND AND SURFACE IMPROVEMENTS. THESE RECORDS SHALL BE DELIVERED TO THE OWNER PRIOR TO THE ACCEPTANCE OF WORK.

SURVEY

- HORIZONTAL COORDINATE SYSTEM: NAD83 CALIFORNIA STATE PLANE, ZONE 2
- VERTICAL DATUM: NAVD88

EXCAVATION

- NOTIFY UNDERGROUND SERVICE ALERT (USA NORTH) TO IDENTIFY THE LOCATION OF EXISTING UTILITIES AT LEAST 48 HOURS (TWO WORKING DAYS) PRIOR TO ANY EXCAVATION WORK: (800)-227-2600 OR WWW.USANORTH.ORG.
- THE CONTRACTOR IS RESPONSIBLE FOR STABILITY AND SHORING OF TEMPORARY CUT SLOPES AND TRENCHES, AND SHALL CONFORM TO THE REQUIREMENTS OF CAL-OSHA.
- EXCAVATIONS SHALL BE KEPT CLEAN AND DRY FOR THE DURATION OF THE WORK PERFORMED.

DEMOLITION

- PROTECT EXISTING FEATURES THAT ARE TO REMAIN IN PLACE FROM DAMAGE UNLESS OTHERWISE NOTED.

EARTHWORK

- PREPARE DESIGNATED FILL AREAS BY GRUBBING AND STRIPPING VEGETATION, REMOVING DEBRIS, AND SCARIFYING TO A MINIMUM DEPTH OF 8 INCHES PRIOR TO MATERIAL PLACEMENT.
- UNLESS OTHERWISE NOTED, COMPACT FILL MATERIAL IN 8-INCH LOOSE LIFTS AND COMPACT TO AT LEAST 90% RELATIVE COMPACTION (RC) AT AN OVER OPTIMUM MOISTURE CONTENT PER ASTM D1557.
- FILL MATERIAL SHALL BE FREE OF ORGANIC MATERIAL AND SHALL CONSIST OF:
  - ENGINEERED ROCKFILL: LESS THAN 20% FINES. 8" SCREENED OUT. 93% COMPACTION MIN.
  - PRIMARY ARMOR STONE: 8T GRADATION (CALTRANS) HAND PLACED.
  - SECONDARY ARMOR STONE; 1/2T GRADATION (CALTRANS).
  - BACKING NO. 1 (CALTRANS).
  - BACKING NO. 3 (CALTRANS).
  - ASTM C33 FINE AGGREGATE.
- PERFORM GRADING TO THE LINES AND GRADES SHOWN. FINISHED SURFACES SHALL PROVIDE POSITIVE SURFACE DRAINAGE TO PREVENT PONDING.

CEMENT DEEP SOIL MIX (CDSM)

- CEMENT DEEP SOIL MIX (CDSM) [NOTE: ADDITIONAL DETAILED SPECS REGARDING REPORTING AND POST PRODUCTION TESTING WILL BE PROVIDED IN FINAL PLANS AND SPECS]
  - CONTRACTOR TO DESIGN CDSM SECTIONS TO MEET THE FOLLOWING PERFORMANCE CRITERIA
    - MINIMUM 28-DAY COMPRESSIVE STRENGTH = 110 PSI
    - MINIMUM AREA REPLACEMENT RATIO IN TREATMENT AREAS = 0.26
    - MIN EMBEDMENT INTO ROCK = 1 FT
    - MINIMUM COLUMN DIAMETER = 2 FT
    - MINIMUM RATIO OF OVERLAP DISTANCE TO COLUMN CENTERLINE = 0.30
  - CONTRACTOR TO PROVIDE DESIGN CALCULATIONS DETAILING MEANS AND METHODS FOR REVIEW AND APPROVAL BY ENGINEER.
  - CONTRACTOR TO PERFORM PILOT FIELD TEST PROGRAM PRIOR TO PRODUCTION INSTALLATION
    - PILOT PROGRAM TO INCLUDE INSTALLATION OF AT LEAST ONE CDSM TEST CELL (40 FT BY 40 FT)
    - TEST CELL MAY BE CONSTRUCTED IN THE LOCATION OF A FINAL PRODUCTION CELL, HOWEVER IF THE TEST CELL DOES NOT MEET THE PROJECT REQUIREMENTS, IT WILL BE THE CONTRACTOR'S RESPONSIBILITY TO MODIFY THE TEST CELL TO MEET THE PROJECT REQUIREMENTS, INCLUDING ANY REVISIONS TO THE DESIGN OF THE CDSM.
    - CONTRACTOR SHALL PERFORM CORING THROUGH THE TEST CELL COLUMNS AT A MINIMUM OF 3 LOCATIONS TO OBTAIN SAMPLES FOR STRENGTH TESTING.
  - AFTER RECEIVING APPROVAL FROM THE ENGINEER, PRODUCTION INSTALLATION MAY BEGIN.
  - CONTRACTOR SHALL PROVIDE DETAILED RECORDS OF THE INSTALLATION PROCESS [NOTE: DETAILS WILL BE PROVIDED IN FINAL DESIGN SUBMITTAL]
  - QA/QC
    - THE CONTRACTOR SHOULD PERFORM ALL CORING OPERATIONS IN THE PRESENCE OF THE ENGINEER. THE CONTRACTOR SHOULD NOTIFY THE ENGINEER AT LEAST 1 BUSINESS DAY IN ADVANCE OF BEGINNING SAMPLING OPERATIONS.
    - THE CONTRACTOR SHOULD DETERMINE THE TIME INTERVAL BETWEEN ELEMENT INSTALLATION AND CORING EXCEPT THAT THE INTERVAL SHOULD BE NO LONGER THAN REQUIRED TO CONDUCT 28-DAY STRENGTH TESTING.
    - THE FULL-DEPTH SAMPLES SHOULD BE OBTAINED ALONG A VERTICAL ALIGNMENT LOCATED ONE-FOURTH OF A COLUMN DIAMETER FROM THE COLUMN CENTER. IF IT IS DIFFICULT TO AVOID DRILLING OUT OF THE COLUMN AT THIS CORING LOCATION, THE CONTRACTOR MAY DRILL ONE-FOURTH OF A COLUMN DIAMETER ALONG THE CENTERLINE OF AN ELEMENT OR SHEAR WALL SO THE CORE ENTERS THE ADJACENT COLUMN IN THE SAME ELEMENT.
    - CORE SAMPLES SHOULD BE RETRIEVED USING STANDARD TRIPLE-TUBE OR EQUIVALENT CONTINUOUS CORING TECHNIQUES.
    - SAMPLES SHOULD HAVE A DIAMETER OF AT LEAST 2.5 INCHES (65 MM), AND EACH CORE RUN SHOULD BE AT LEAST 3 FT IN LENGTH.
    - FOR EACH FIELD VALIDATION TEST SECTION, THE CONTRACTOR SHOULD COLLECT AT LEAST ONE FULL-DEPTH CORE FOR EACH MIX DESIGN AT LOCATIONS DEFINED BY THE OWNER/ENGINEER.
    - THE CONTRACTOR SHOULD COLLECT ONE FULL-DEPTH CORE FROM 3 PERCENT OF ELEMENTS OR 860 FT<sup>2</sup> OF TREATED AREA, WHICHEVER PRODUCES A LARGER NUMBER OF CORED ELEMENTS. THE CORES SHOULD BE DRILLED AT LOCATIONS DEFINED BY THE OWNER/ENGINEER. AN ELEMENT IS DEFINED AS THE TREATED SOIL PRODUCED BY ONE SETUP OF EITHER A SINGLE- OR MULTIPLE-AXIS MACHINE.
    - THE CONTRACTOR SHOULD PHOTOGRAPH EACH CORE RUN.
    - UPON RETRIEVAL, THE CONTRACTOR SHOULD PROVIDE THE CORES TO THE ENGINEER FOR LOGGING AND TEST SPECIMEN SELECTION.
    - FOLLOWING LOGGING, THE ENGINEER WILL SELECT AT LEAST THREE SPECIMENS FROM EACH FULL-DEPTH CONTINUOUS CORE FOR STRENGTH TESTING. EACH TEST SPECIMEN SHOULD HAVE A LENGTH-TO-DIAMETER RATIO OF 2 OR GREATER.
    - IMMEDIATELY FOLLOWING LOGGING AND TEST SPECIMEN SELECTION BY THE ENGINEER, THE CONTRACTOR SHOULD SEAL THE ENTIRE FULL-DEPTH SAMPLE, INCLUDING THE DESIGNATED TEST SPECIMENS, IN PLASTIC WRAP TO PREVENT DRYING AND TRANSPORT THE SEALED SAMPLE TO THE LABORATORY. THE SAMPLES SHOULD BE PROTECTED AGAINST DRYING AND MECHANICAL DAMAGE PRIOR TO AND DURING TRANSPORT.
    - THE CONTRACTOR SHOULD RETAIN PORTIONS OF THE SAMPLES THAT ARE NOT TESTED UNTIL COMPLETION AND ACCEPTANCE OF ALL WORK FOR POSSIBLE FUTURE INSPECTION AND CONFIRMATION TESTING BY THE ENGINEER.
    - ALL CORE HOLES SHOULD BE FILLED WITH CEMENT GROUT THAT WILL OBTAIN A 28-DAY UNCONFINED COMPRESSIVE STRENGTH EQUAL TO OR GREATER THAN THE 28-DAY UNCONFINED COMPRESSIVE STRENGTH OF THE DEEP MIXED MATERIAL.

INSPECTION AND OBSERVATION

- CONSTRUCTION OBSERVATION BY AN INSPECTOR AND/OR THE ENGINEER IS REQUIRED AT THE FOLLOWING STAGES OF CONSTRUCTION:
  - ...
  - ...
  - ...
- REFER TO THE SPECIFICATIONS AND CONTRACT DOCUMENTS FOR ADDITIONAL QUALITY CONTROL/INSPECTION REQUIREMENTS.
- NOTIFY THE INSPECTOR/ENGINEER AT LEAST 48 HOURS BEFORE INSPECTION OR OBSERVATION IS NEEDED.

LEGEND & ABBREVIATIONS

(E)	— 3500 —	MAJOR CONTOUR
(E)	— — —	MINOR CONTOUR
(N)	— 3500 —	MAJOR CONTOUR
(N)	— — —	MINOR CONTOUR
AB		AGGREGATE BASE
APPROX		APPROXIMATE
CJ		CONSTRUCTION JOINT
€		CENTER LINE
CLR		CLEAR
CMP		CORRUGATED METAL PIPE
CONC		CONCRETE
CSP		CORRUGATED STEEL PIPE
D/S		DOWNSTREAM
D		DIAMETER OR PIPE DIAMETER
DEMO		DEMOLISH
DI		DRAINAGE INLET
DWG		DRAWING
(E)		EXISTING FEATURE
EG		EXISTING GRADE
EJ		EXPANSION JOINT
ER		EDGE OF ROAD
FG		FINISH GRADE
FL		FLOWLINE
HDPE		HIGH-DENSITY POLYETHYLENE
HWY		HIGHWAY
INV		INVERT
LF		LINEAR FEET
MAX		MAXIMUM
MIN		MINIMUM
(N)		NEW FEATURE
OAE		OR APPROVED EQUIVALENT
OC		ON CENTER
PERF		PERFORATED
PVC		POLYVINYL CHLORIDE
R		RADIUS
RC		RELATIVE COMPACTION
S		SLOPE
SBS		SIDE BOTTOM SIDE
SCH		SCHEDULE
SD		STORM DRAIN
SDR		STANDARD DIMENSION RATIO
SPEC		SPECIFICATION
SST		STAINLESS STEEL
STA		STATION
STD		STANDARD
T		TRANSVERSE CUTOFF
TOS		TOP OF SHOTCRETE
TOT		TOTAL
TYP		TYPICAL
TW		TOP OF WALL
U/S		UPSTREAM
UV		ULTRAVIOLET
WWR		WELDED WIRE REINFORCEMENT

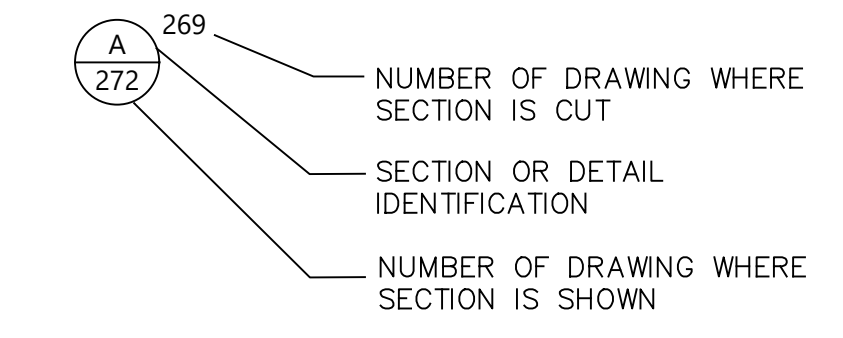

SUBMITTAL	SPECIFICATION	WHEN DUE

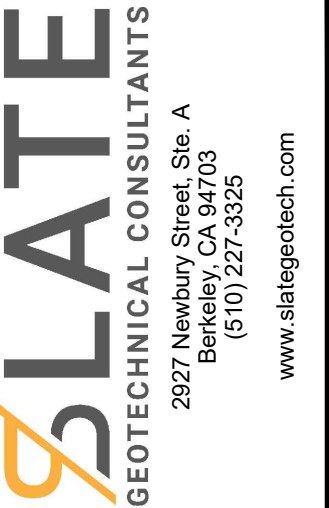

DESCRIPTION	DATE	BY	REV

NOTES & ABBREVIATIONS  
MILL POND DAM

NOT FOR CONSTRUCTION

DATE: 03/29/2022  
SCALE: NTS  
DESIGNED BY: J. LEATHAM  
DRAFTED BY: J. LEATHAM  
CHECKED BY: M. RYAN  
JOB NO.: 22-079-01  
FILE: 17-031.02.dwg

2

SHEET 2 OF 15

60% NOT FOR CONSTRUCTION

PLOT DATE: Tuesday, May 10, 2022 TIME: 10:56:13 AM BY: STEPHANIE GOTTSCH  
FILE: c:\bms\kjee-pw\0207949\17-031.02.dwg



CALIFORNIA  
MENOCINGO COUNTY  
FORT BRAGG

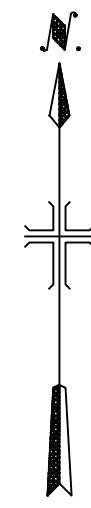

- LEGEND**
- - - - - EXISTING GROUND CONTOUR, 5' INTERVAL
  - - - - - EXISTING GROUND CONTOUR, 1' INTERVAL
  - (E) MAXIMUM WATER SURFACE ELEVATION +39.0'
  - (N) GRADING BOUNDARY

- NOTES:**
1. TOPOGRAPHIC DATA FROM 2005 SURVEY BY DAVID EVANS AND ASSOCIATES.
  2. EXISTING STRUCTURES NOT SHOWN.
  3. HORIZONTAL CONTROL POINTS NOT SHOWN.

SEE SHEET 13 FOR EXPANDED VIEW OF SOUTH DAM IMPROVEMENT AREA

SOUTH DAM IMPROVEMENT AREA

WEST POND

SEE SHEET 10 FOR EXPANDED VIEW OF GRAVITY WALL AREA

(N) GRAVITY WALL

NORTH DAM IMPROVEMENT AREA

EAST POND

SEE SHEET 4, 5 & 6 FOR EXPANDED VIEW OF NORTH DAM IMPROVEMENT AREA

MAXIMUM WATER SURFACE ELEVATION

**PLAN**  
SCALE: 1" = 50'



PLOT DATE: Tuesday, May 10, 2022 TIME: 10:56:15 AM BY: STEPHANIE GOTTSCH  
FILE: c:\bms\k-lee-pw\0207949\17-031.02.dwg

REV	BY	DATE	DESCRIPTION

**SITE IMPROVEMENT PLAN**  
**MILL POND DAM**  
CALIFORNIA  
MENDOCINO COUNTY  
FORT BRAGG

**NOT FOR CONSTRUCTION**

DATE: 03/29/2022  
SCALE: 1"=50'  
DESIGNED BY: J. LEATHAM  
DRAFTED BY: J. LEATHAM  
CHECKED BY: M. RYAN  
JOB NO.: 22-079-01  
FILE: 17-031.02.dwg

**60% NOT FOR CONSTRUCTION**

**LEGEND**

- - - EXISTING GROUND CONTOUR, 5' INTERVAL
- - - EXISTING GROUND CONTOUR, 1' INTERVAL
- (E) MAXIMUM WATER SURFACE ELEVATION +39.0'
- (N) GRADING BOUNDARY

- NOTES:**
1. TOPOGRAPHIC DATA FROM 2005 SURVEY BY DAVID EVANS AND ASSOCIATES.
  2. EXISTING STRUCTURES NOT SHOWN.

QUANTITIES - WORKING PAD	
ITEM	QUANTITY
SOIL REMOVAL	230 CY
NET SOIL FILL	1730 CY

NORTH BUTTRESS FOUNDATION HINGE POINT				
NO	START STA	END STA	LENGTH	BEARING
L1	0+00.00	0+32.95	32.95'	N24°35'52"E
L2	0+32.95	2+85.18	252.23'	N76°23'07"E
L3	2+85.18	4+54.34	169.16'	N49°03'39"E
L4	4+54.34	4+84.00	29.66'	S66°26'42"E

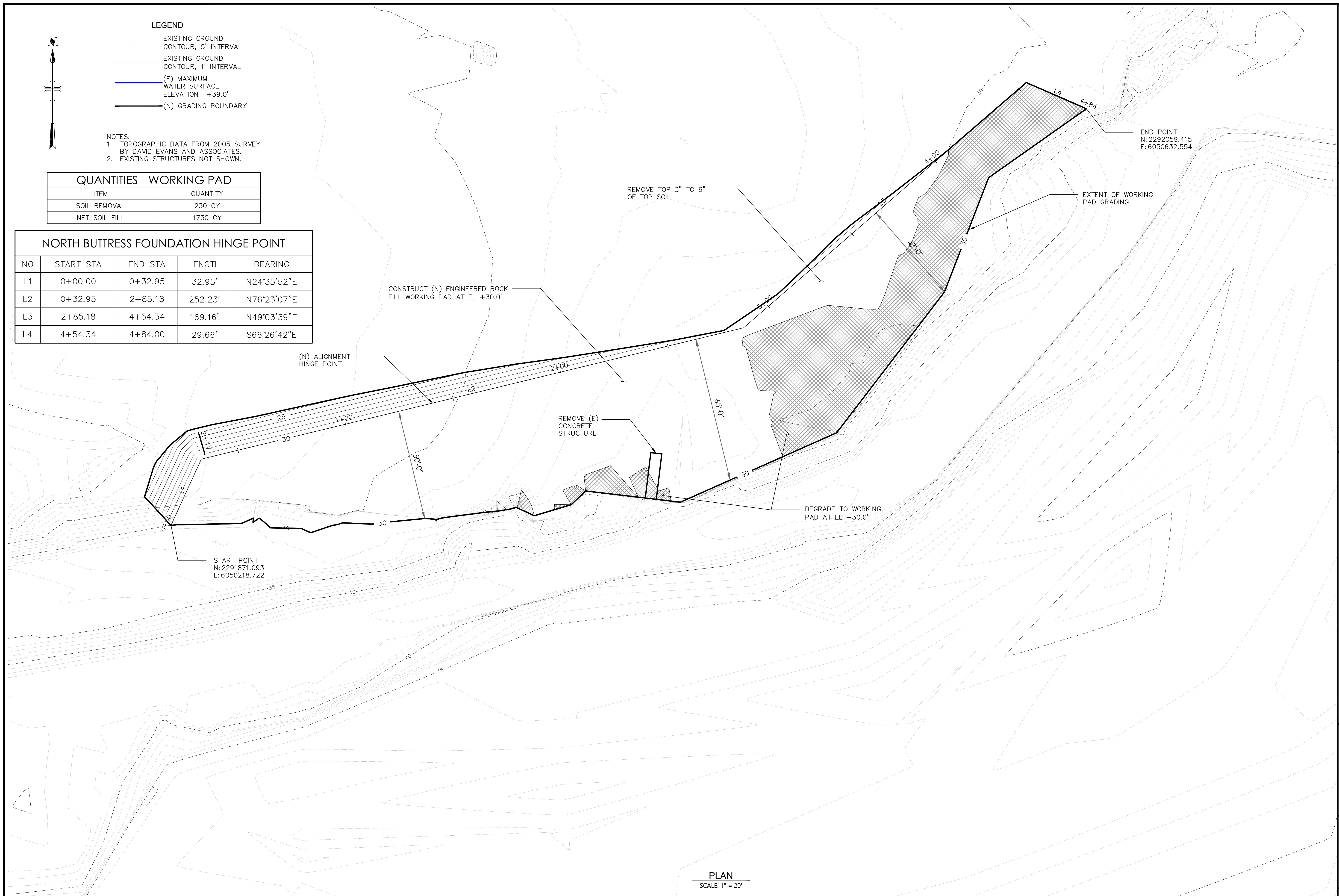

REV	BY	DATE	DESCRIPTION
1			
2			
3			
4			
5			
6			
7			
8			
9			
10			

**NORTH DAM IMPROVEMENT WORKING PAD PLAN**  
**MILL POND DAM**  
 FORT BRAGG  
 MENDOCINO COUNTY  
 CALIFORNIA

**NOT FOR CONSTRUCTION**

DATE: 03/29/2022  
 SCALE: 1"=20'  
 DESIGNED BY: J. LEATHAM  
 DRAFTED BY: J. LEATHAM  
 CHECKED BY: M. RYAN  
 JOB NO.: 22-079-01  
 FILE: 17-031.02.dwg

PLOT DATE: Tuesday, May 10, 2022 TIME: 10:56:17 AM BY: STEPHANIE GOTSCH  
 FILE: c:\bms\kjee-pw\0207949\17-031.02.dwg



PLAN  
 SCALE: 1" = 20'

**60% NOT FOR CONSTRUCTION**

REV	BY	DATE	DESCRIPTION

**NORTH DAM IMPROVEMENT CDSM LAYOUT & DETAIL**  
**MILL POND DAM**  
 FORT BRAGG  
 MENDOCINO COUNTY  
 CALIFORNIA

**NOT FOR CONSTRUCTION**

DATE: 03/29/2022  
 SCALE: 1"=20'  
 DESIGNED BY: J. LEATHAM  
 DRAFTED BY: J. LEATHAM  
 CHECKED BY: M. RYAN  
 JOB NO.: 22-079-01  
 FILE: 17-031.02.dwg

- LEGEND**
- - - - - EXISTING GROUND CONTOUR, 5' INTERVAL
  - - - - - EXISTING GROUND CONTOUR, 1' INTERVAL
  - (E) MAXIMUM WATER SURFACE ELEVATION +39.0'
  - (N) GRADING BOUNDARY

- NOTES:**
1. TOPOGRAPHIC DATA FROM 2005 SURVEY BY DAVID EVANS AND ASSOCIATES.
  2. EXISTING STRUCTURES NOT SHOWN.

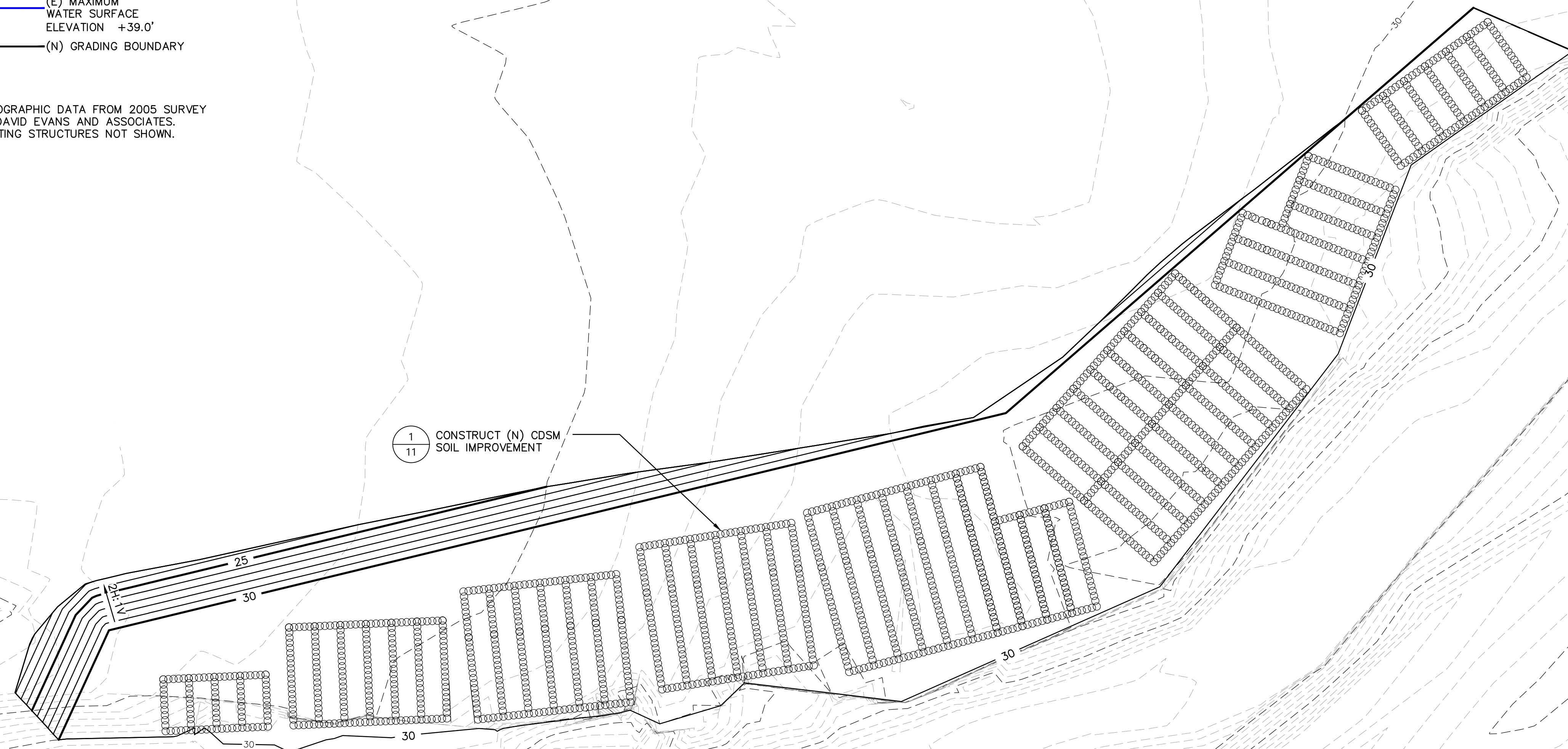
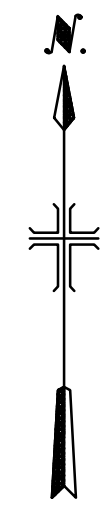

**PLAN**  
 SCALE: 1" = 20'

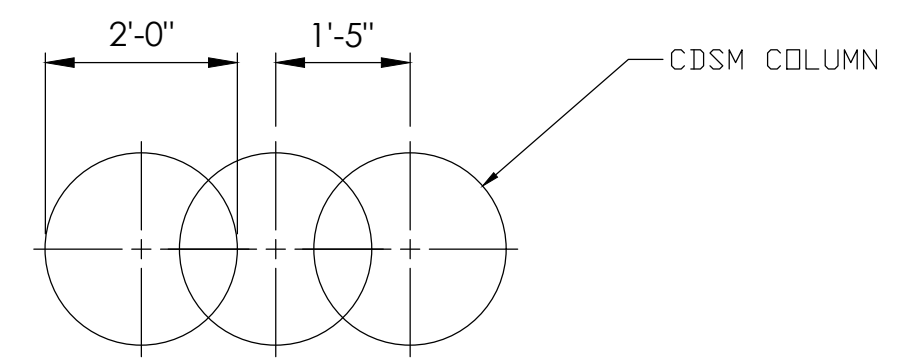
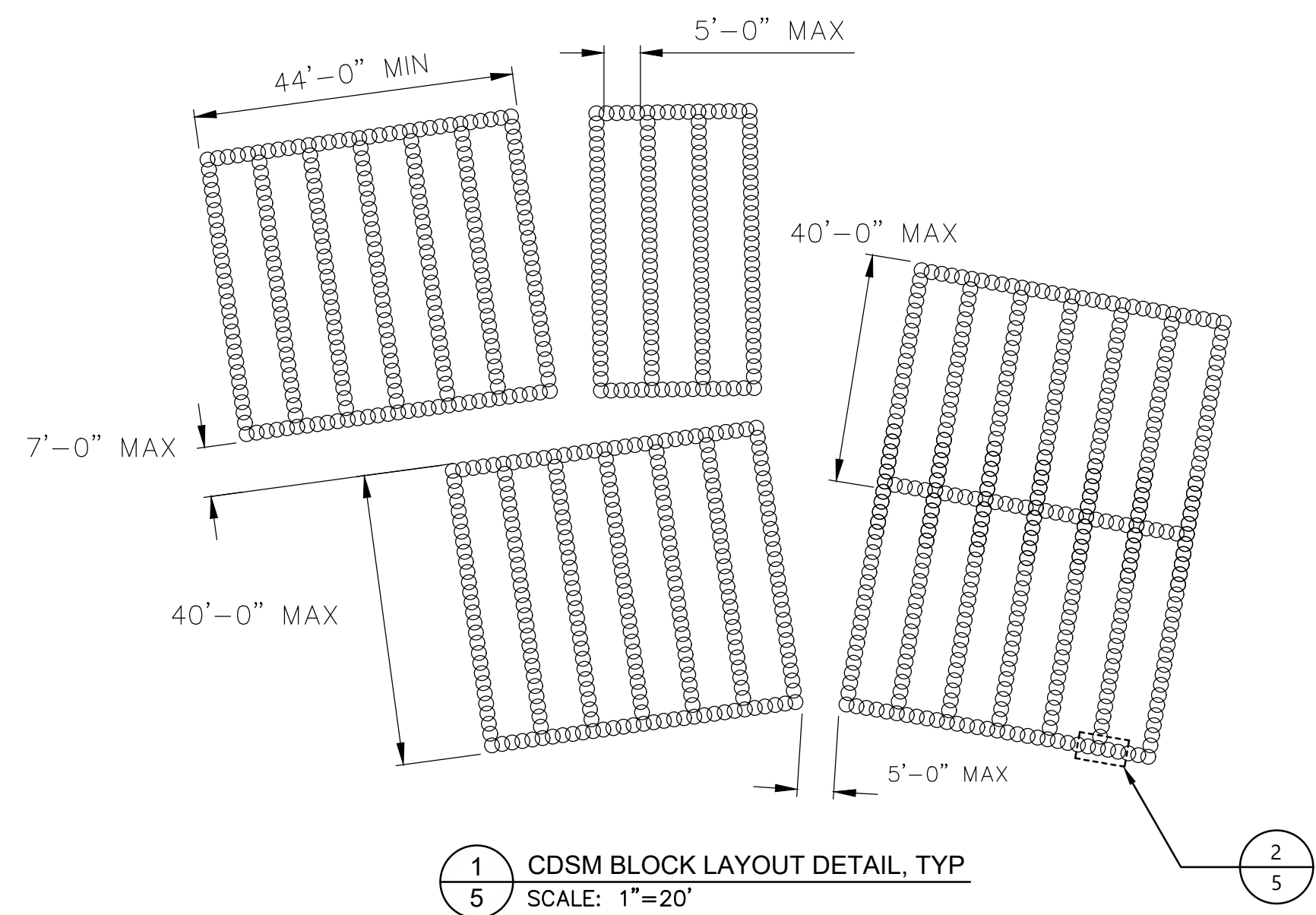

**CDSM COLUMN DIAMETER & SPACING DETAIL, TYP**  
 SCALE: 1"=2'

**CDSM BLOCK LAYOUT DETAIL, TYP**  
 SCALE: 1"=20'

PLOT DATE: Tuesday, May 10, 2022 TIME: 10:56:20 AM BY: STEPHANIE GOTTSCH  
 FILE: c:\bms\jlee-pw\0207949\17-031.02.dwg



**60% NOT FOR CONSTRUCTION**

**LEGEND**

- - - - - EXISTING GROUND CONTOUR, 5' INTERVAL
- - - - - EXISTING GROUND CONTOUR, 1' INTERVAL
- (E) MAXIMUM WATER SURFACE ELEVATION +39.0'
- (N) GRADING BOUNDARY

- NOTES:**
1. TOPOGRAPHIC DATA FROM 2005 SURVEY BY DAVID EVANS AND ASSOCIATES.
  2. EXISTING STRUCTURES NOT SHOWN.

QUANTITIES - NORTH BUTTRISS	
ITEM	QUANTITY
ENGINEERED ROCK FILL	5704 CY

NORTH BUTTRISS UPPER BENCH HINGE POINT				
NO	START STA	END STA	LENGTH	BEARING
L5	0+00.00	0+44.07	44.07'	N39°28'03"E
L6	0+44.07	2+74.53	230.46'	N74°21'21"E
L7	2+74.53	4+62.22	187.69'	N48°09'01"E

PLOT DATE: Tuesday, May 10, 2022 TIME: 10:56:22 AM BY: STEPHANIE GOTSCH  
 FILE: c:\bms\kjee-pw\0207949\17-031.02.dwg



**PLAN**  
 SCALE: 1" = 20'

**60% NOT FOR CONSTRUCTION**

REV	BY	DATE	DESCRIPTION

**NORTH BUTTRISS IMPROVEMENT PLAN**  
**MILL POND DAM**  
 FORT BRAGG  
 MENDOCINO COUNTY  
 CALIFORNIA

**NOT FOR CONSTRUCTION**

DATE: 03/29/2022  
 SCALE: 1"=20'  
 DESIGNED BY: J. LEATHAM  
 DRAFTED BY: J. LEATHAM  
 CHECKED BY: M. RYAN  
 JOB NO.: 22-079-22  
 FILE: 17-031.02.dwg

DESCRIPTION

DATE

BY

REV

NORTH DAM IMPROVEMENT SECTIONS A & B  
 MILL POND DAM

CALIFORNIA

MENDOCINO COUNTY

FORT BRAGG

NOT FOR  
 CONSTRUCTION

DATE: 03/29/2022  
 SCALE: 1"=10'  
 DESIGNED BY: J. LEATHAM  
 DRAFTED BY: J. LEATHAM  
 CHECKED BY: M. RYAN  
 JOB NO.: 22-079-01  
 FILE: 17-031.02.dwg

7

SHEET 7 OF 15

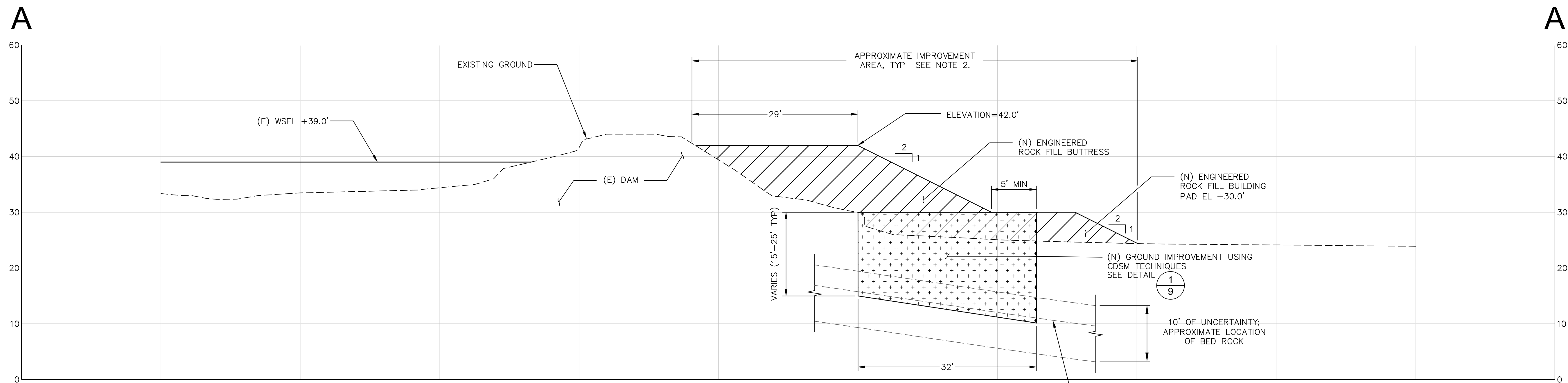

**A** SECTION (THRU NORTH DAM)  
 SCALE: 1"=10'

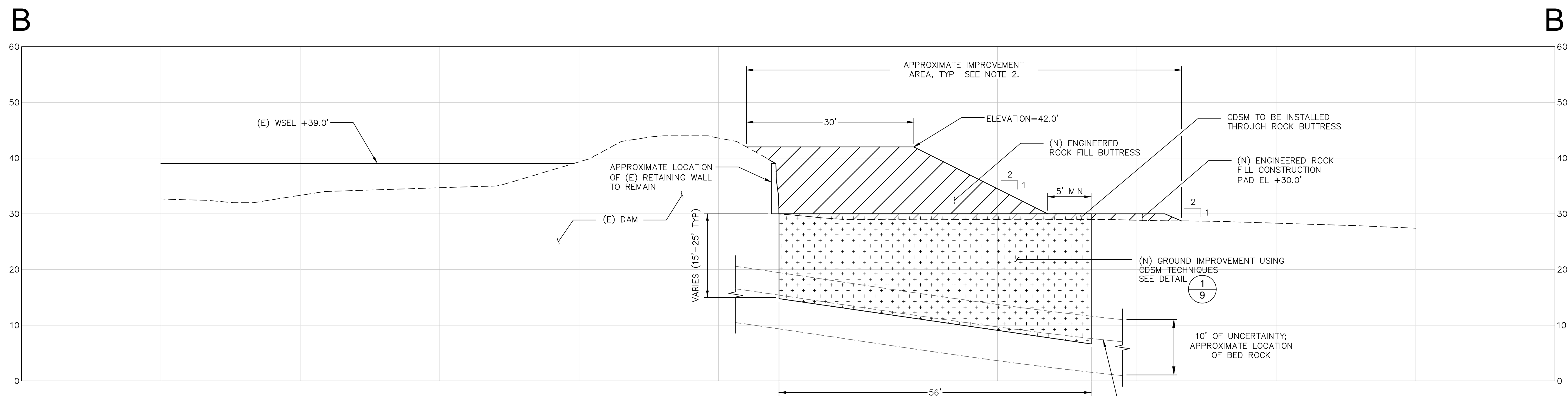

**B** SECTION (THRU NORTH DAM)  
 SCALE: 1"=10'

- NOTES:  
 1. EXISTING STRUCTURES NOT SHOWN ON PLAN.  
 2. LENGTH, WIDTH AND DEPTH OF IMPROVEMENT AREA TO BE CONFIRMED DURING CONSTRUCTION.

PLOT DATE: Tuesday, May 10, 2022 TIME: 10:56:24 AM BY: STEPHANIE GOTTSCH  
 FILE: c:\bms\p\p\00207949\17-031.02.dwg



60% NOT FOR CONSTRUCTION

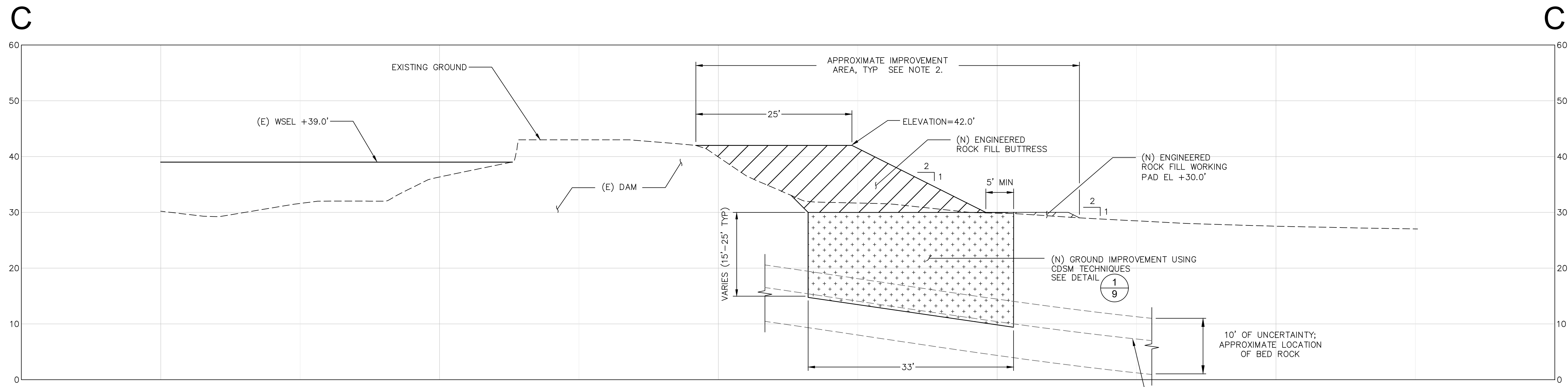

**C**  
**8** SECTION (THRU NORTH DAM)  
 SCALE: 1"=10'

REV	BY	DATE	DESCRIPTION
1			
2			
3			
4			
5			
6			
7			
8			

**NORTH DAM IMPROVEMENT SECTION C**  
**MILL POND DAM**  
 FORT BRAGG  
 MENDOCINO COUNTY  
 CALIFORNIA

**NOT FOR CONSTRUCTION**

DATE: 03/29/2022  
 SCALE: 1"=10'  
 DESIGNED BY: J. LEATHAM  
 DRAFTED BY: J. LEATHAM  
 CHECKED BY: M. RYAN  
 JOB NO.: 22-079-01  
 FILE: 17-031.02.dwg

PLOT DATE: Tuesday, May 10, 2022 TIME: 10:56:25 AM BY: STEPHANIE GOTTSCH  
 FILE: c:\bms\p\0207949\17-031.02.dwg



- NOTES:  
 1. EXISTING STRUCTURES NOT SHOWN ON PLAN.  
 2. LENGTH, WIDTH AND DEPTH OF IMPROVEMENT AREA TO BE CONFIRMED DURING CONSTRUCTION.

**60% NOT FOR CONSTRUCTION**

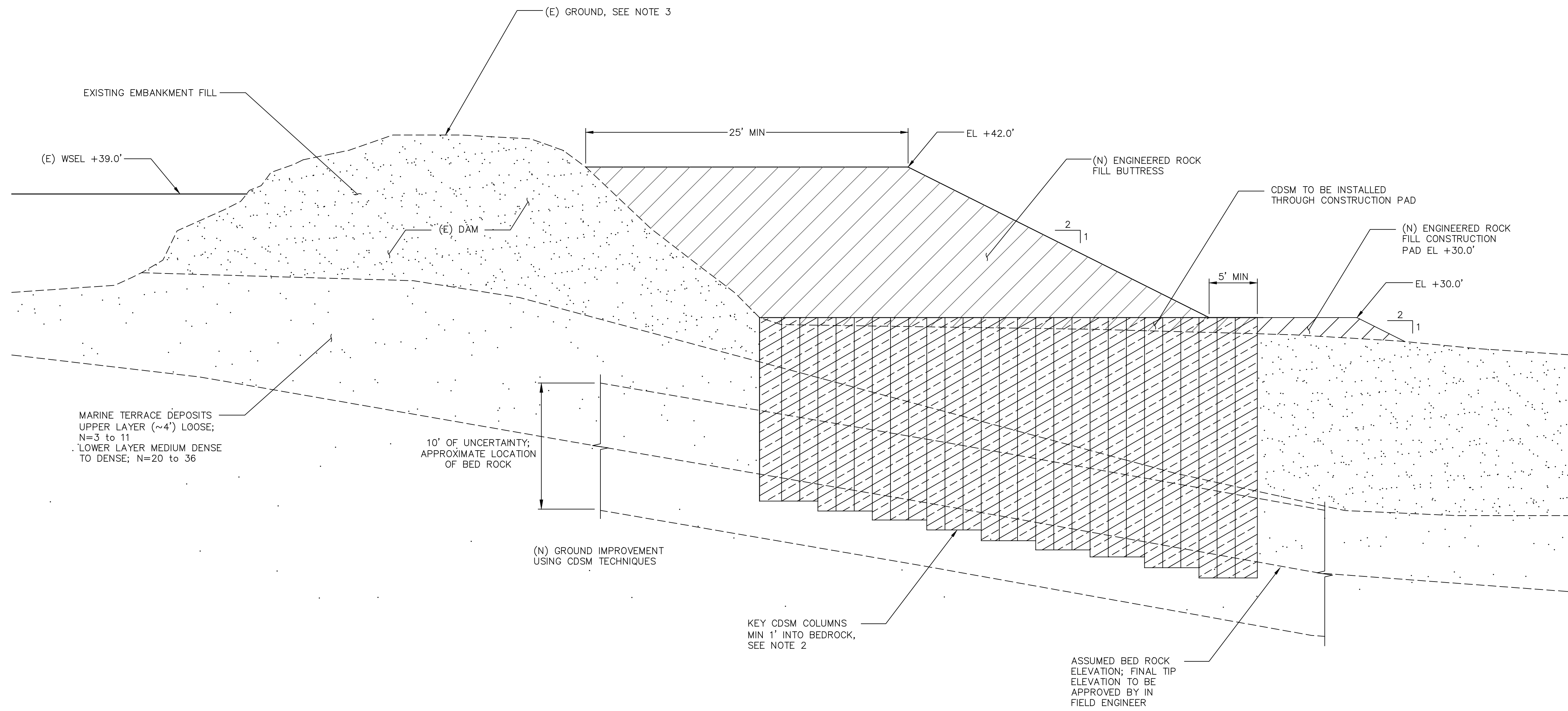

1 IMPROVEMENT AREA DETAIL, TYP  
 9 SCALE: NOT TO SCALE

- NOTES:
- SEE SECTIONS FOR ELEVATION DATA.
  - LENGTH, WIDTH AND DEPTH OF IMPROVEMENT AREA TO BE CONFIRMED DURING CONSTRUCTION.
  - STRIP ALL VEGETATION AND ORGANICS FROM SLOPE PRIOR TO PLACING ENGINEERED ROCK FILL BUTTRESS.

REV	BY	DATE	DESCRIPTION
1			
2			
3			
4			
5			
6			
7			
8			
9			

NORTH DAM IMPROVEMENT SECTION DETAIL  
 MILL POND DAM  
 FORT BRAGG  
 MENDOCINO COUNTY  
 CALIFORNIA

NOT FOR CONSTRUCTION

DATE: 03/29/2022  
 SCALE: NTS  
 DESIGNED BY: J. LEATHAM  
 DRAFTED BY: J. LEATHAM  
 CHECKED BY: M. RYAN  
 JOB NO.: 22-079-01  
 FILE: 17-031.02.dwg

PLOT DATE: Tuesday, May 10, 2022 TIME: 10:56:26 AM BY: STEPHANIE GOTTSCH  
 FILE: c:\bms\pwworking\17-031.02.dwg

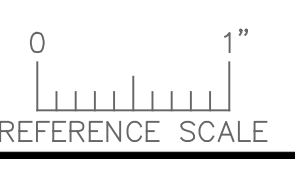

60% NOT FOR CONSTRUCTION



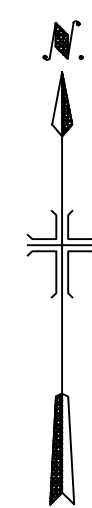

**LEGEND**

- - - - - EXISTING GROUND CONTOUR, 5' INTERVAL
- - - - - EXISTING GROUND CONTOUR, 1' INTERVAL
- (E) WSEL +39.0'

**NOTES:**

1. ESTIMATED LENGTH OF GRAVITY WALL IS 62.5 FEET, TO BE CONFIRMED IN THE FIELD.

GRAVITY WALL CENTERLINE				
NO	START STA	END STA	LENGTH	BEARING
LB	0+00.00	0+62.52	62.52'	S00°00'00"E

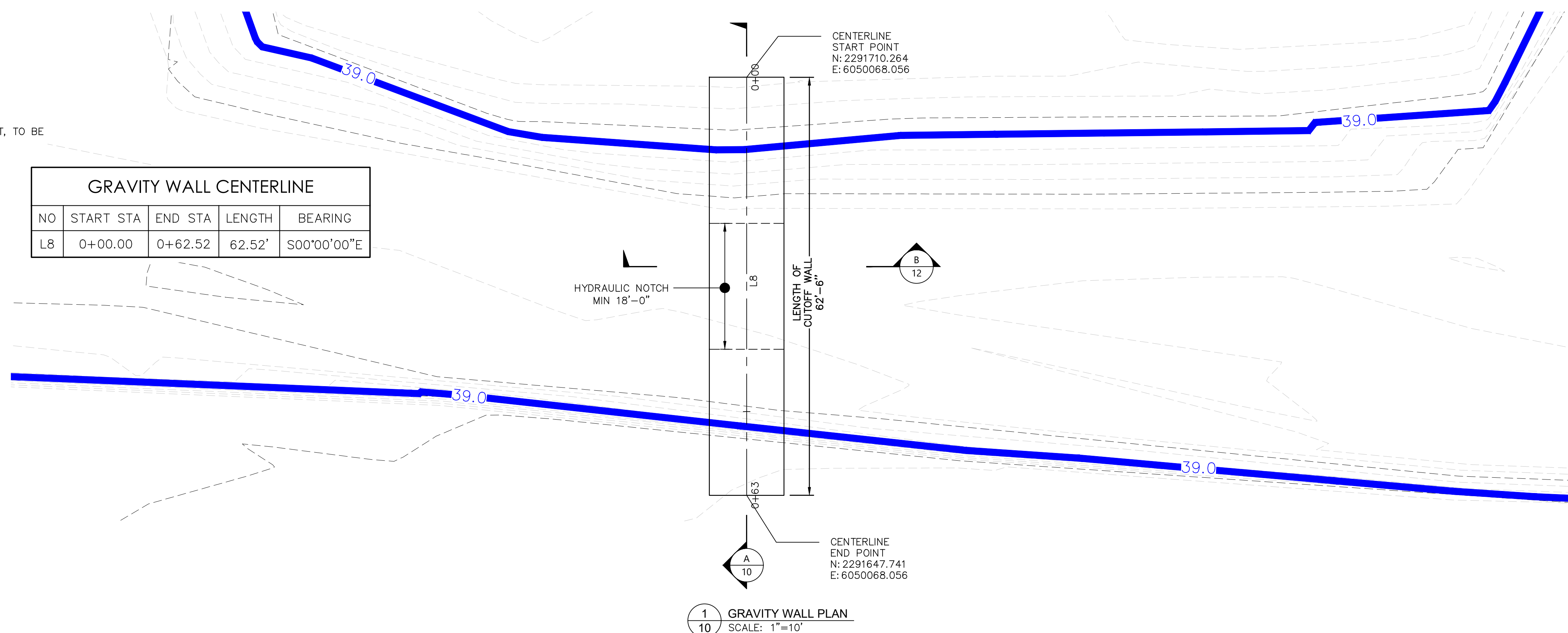

**1**  
**10** GRAVITY WALL PLAN  
SCALE: 1"=10'

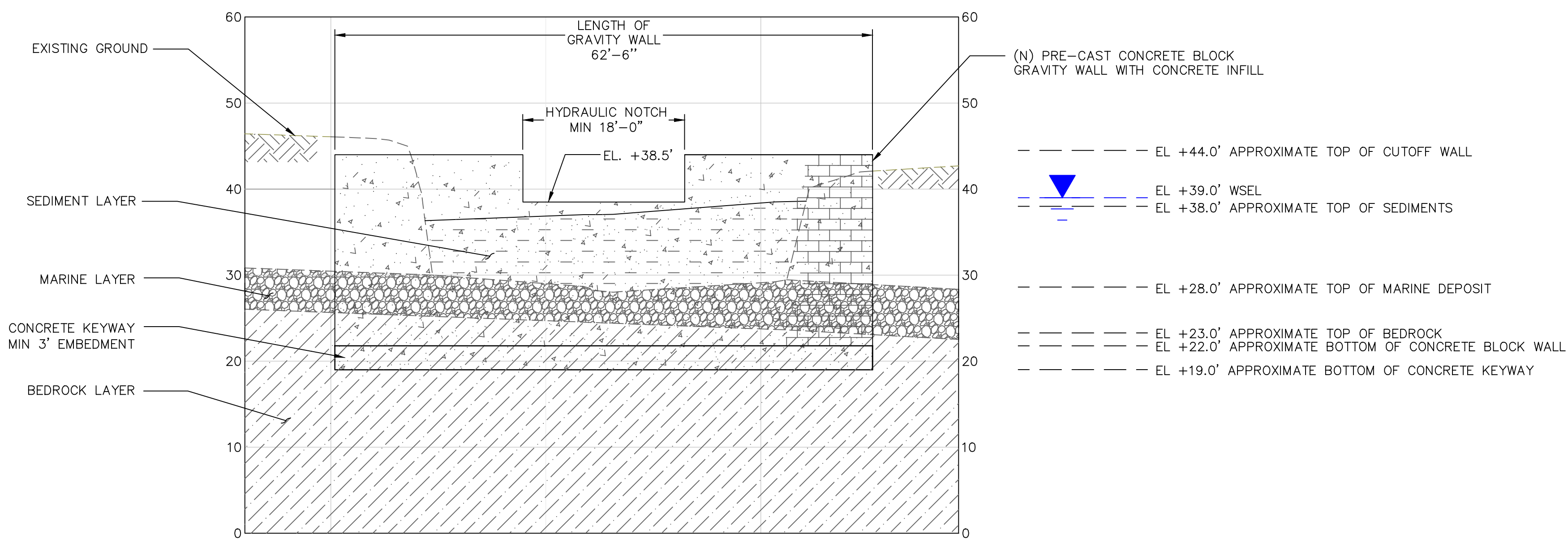

**A**  
**10** GRAVITY WALL SECTION  
SCALE: 1"=10'

REV	BY	DATE	DESCRIPTION
1			
2			
3			
4			
5			
6			
7			
8			
9			
10			

**GRAVITY WALL PLAN & SECTION**  
**MILL POND DAM**

CALIFORNIA

MENDOCINO COUNTY

FORT BRAGG

**NOT FOR CONSTRUCTION**

DATE: 03/29/2022  
 SCALE: NTS  
 DESIGNED BY: J. LEATHAM  
 DRAFTED BY: J. LEATHAM  
 CHECKED BY: M. RYAN  
 JOB NO.: 22-079-01  
 FILE: 17-031.02.dwg

**10**

SHEET 10 OF 15

**60% NOT FOR CONSTRUCTION**



PLOT DATE: Tuesday, May 10, 2022 TIME: 10:56:28 AM BY: STEPHANIE GOTTSCH  
FILE: c:\bms\p\0207949\17-031.02.dwg



(SHEET INTENTIONALLY LEFT BLANK)



REV	BY	DATE	DESCRIPTION
1			
2			
3			
4			
5			

**SOLDIER PILE WALL DETAILS**  
**MILL POND DAM**

FORT BRAGG MENDOCINO COUNTY CALIFORNIA

**NOT FOR CONSTRUCTION**

DATE: 03/29/2022  
SCALE: 1"=50'  
DESIGNED BY: J. LEATHAM  
DRAFTED BY: J. LEATHAM  
CHECKED BY: M. RYAN  
JOB NO.: 22-079-01  
FILE: 17-031.02.dwg

**60% NOT FOR CONSTRUCTION**

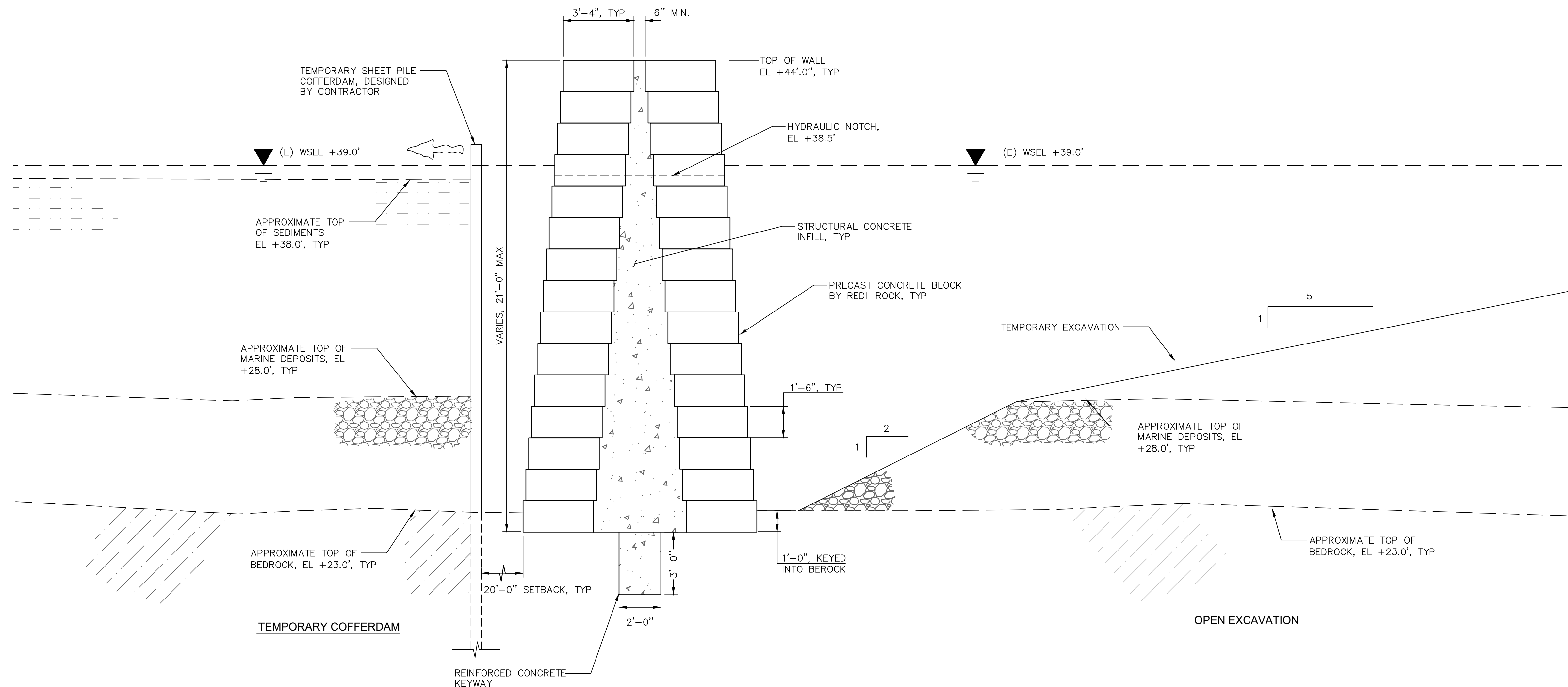

**B**  
**10** GRAVITY WALL SECTION  
 NTS

REV	BY	DATE	DESCRIPTION
1			
2			
3			
4			
5			

**GRAVITY WALL SECTION**  
**MILL POND DAM**

CALIFORNIA  
 MENOCINGO COUNTY  
 FORT BRAGG

**NOT FOR CONSTRUCTION**

DATE: 03/29/2022  
 SCALE: NTS  
 DESIGNED BY: J. LEATHAM  
 DRAFTED BY: J. LEATHAM  
 CHECKED BY: M. RYAN  
 JOB NO.: 22-079-01  
 FILE: 17-031.02.dwg

**NOTES:**  
 1. SEDIMENT ELEVATION AT TYPICAL DEPTH.  
 2. NOTCH DIMENSIONS MIN 18 FT WIDTH, WITH LOWER INVERT ELEVATION OF 38.5'  
 3. SECTION SHOWS TWO OPTIONS FOR TEMPORARY CONSTRUCTION EXCAVATION. GRAVITY WALL TO BE BACKFILLED EVENLY ON BOTH SIDES TO ORIGINAL SEDIMENT LINE AT COMPLETION.

PLOT DATE: Tuesday, May 10, 2022 TIME: 10:56:30 AM BY: STEPHANIE GOTTSCH  
 FILE: c:\bms\k\ee-pw\0207949\17-031.02.dwg



**60% NOT FOR CONSTRUCTION**

**LEGEND**  
 - - - - - EXISTING GROUND CONTOUR, 5' INTERVAL  
 - - - - - EXISTING GROUND CONTOUR, 1' INTERVAL  
 ——— (N) GRADING BOUNDARY

- NOTES:**  
 1. TOPOGRAPHIC DATA FROM 2005 SURVEY BY DAVID EVANS AND ASSOCIATES.  
 2. EXISTING STRUCTURES NOT SHOWN.  
 3. WETLAND DELINEATION NOT SHOWN.  
 4. SPILLWAY IMPROVEMENT MEASURES WILL INCLUDE PLACEMENT OF RSP AT THE TOE OF SPILLWAY.

QUANTITIES - SOUTH RSP BUTTRESS	
ITEM	QUANTITY
TOTAL FILL VOLUME	1375 CY

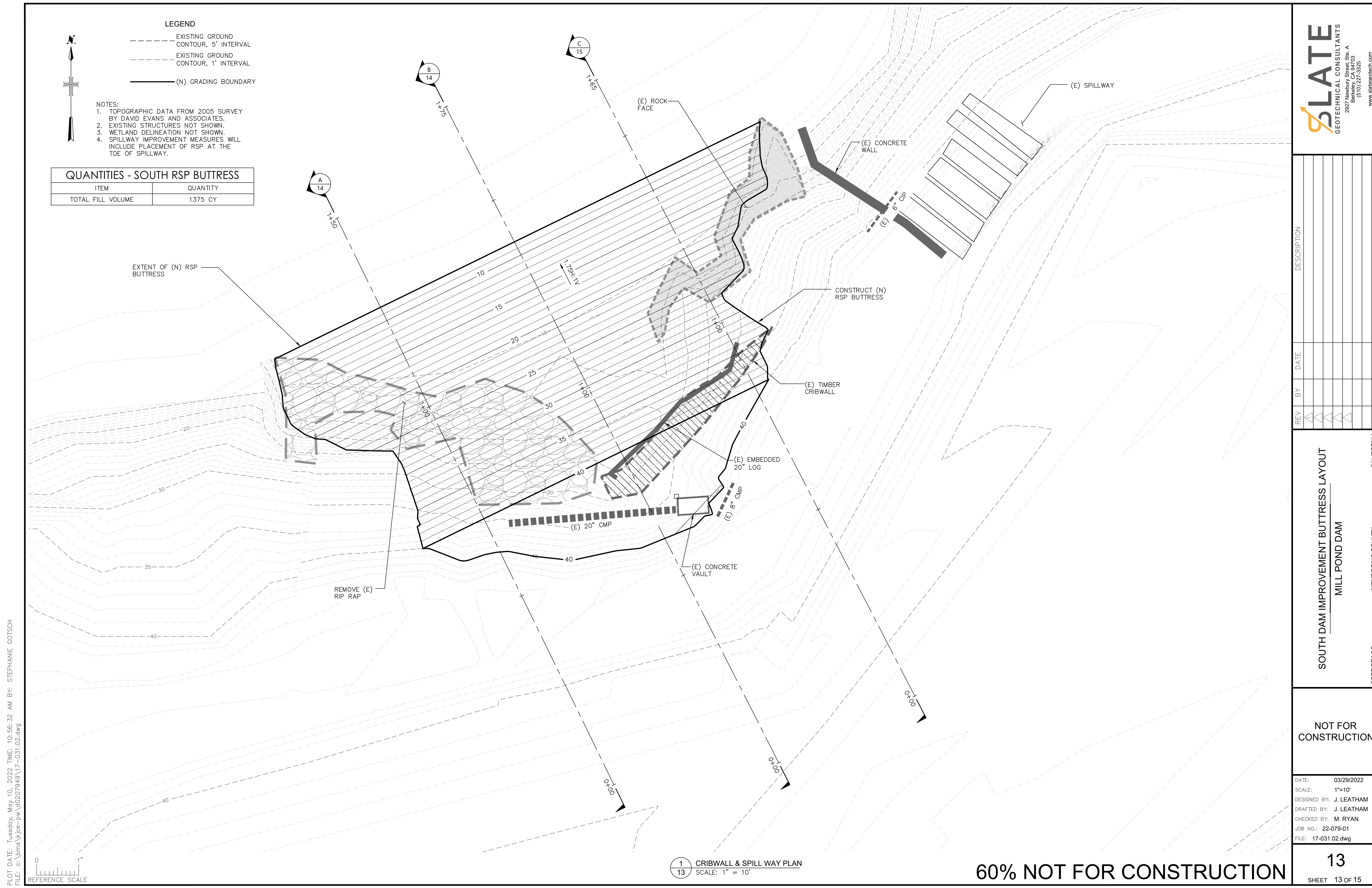

REV	BY	DATE	DESCRIPTION

**SOUTH DAM IMPROVEMENT BUTTRESS LAYOUT**  
**MILL POND DAM**  
 FORT BRAGG MENDOCINO COUNTY CALIFORNIA

**NOT FOR CONSTRUCTION**

DATE: 03/29/2022  
 SCALE: 1"=10'  
 DESIGNED BY: J. LEATHAM  
 DRAFTED BY: J. LEATHAM  
 CHECKED BY: M. RYAN  
 JOB NO.: 22-079-01  
 FILE: 17-031.02.dwg

PLOT DATE: Tuesday, May 10, 2022 TIME: 10:56:32 AM BY: STEPHANIE GOTTSCH  
 FILE: c:\bms\kjee-pw\0207949\17-031.02.dwg



**1**  
**13** CRIBWALL & SPILL WAY PLAN  
 SCALE: 1" = 10'

**60% NOT FOR CONSTRUCTION**

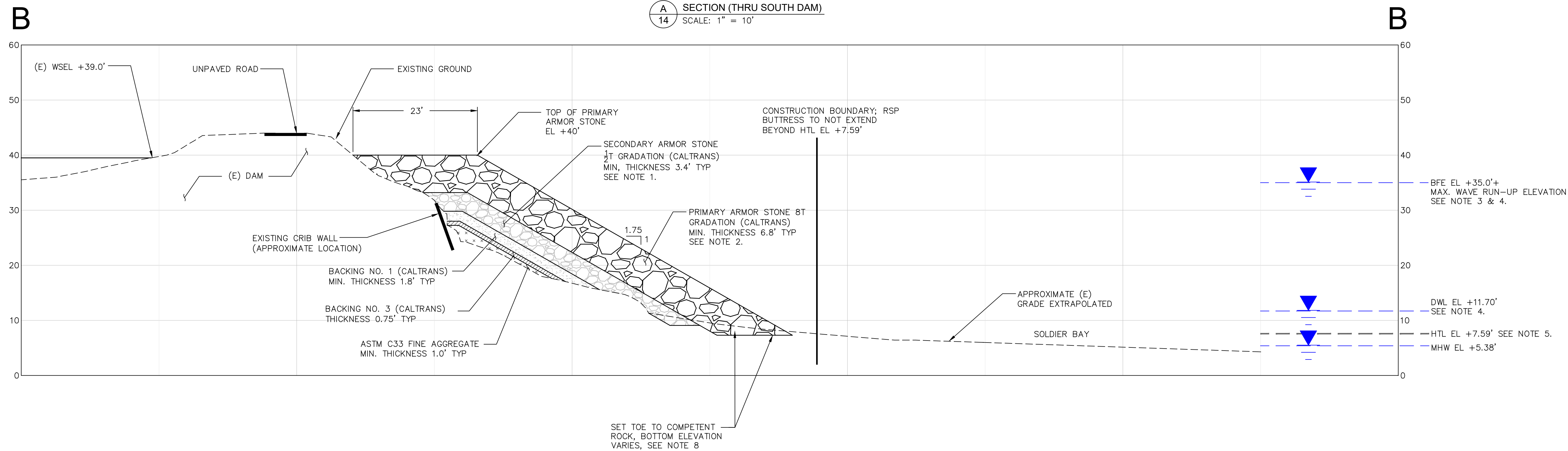
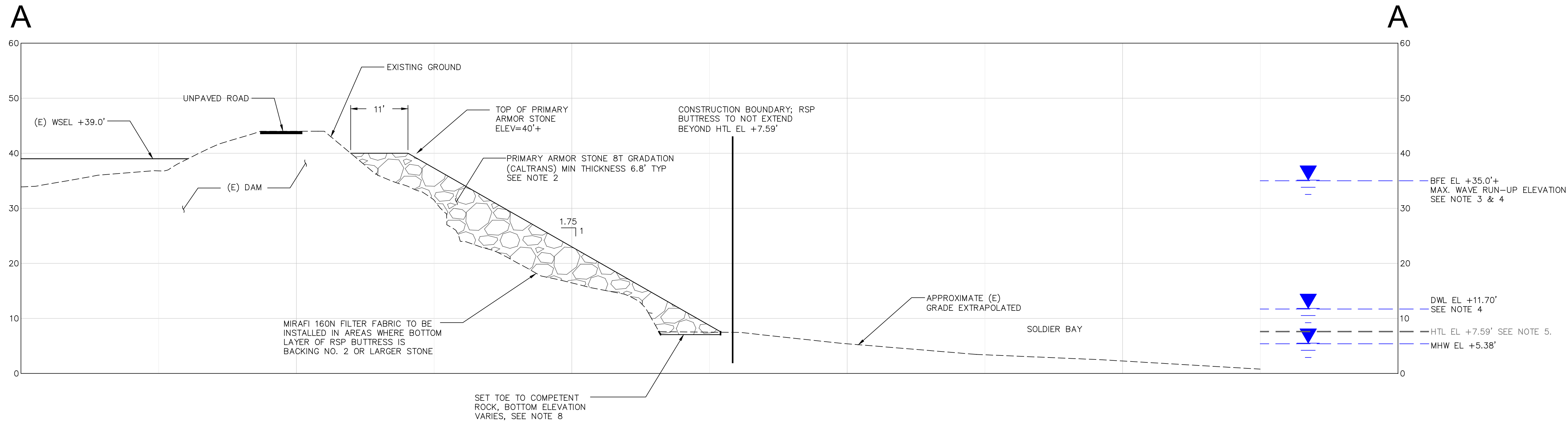

**NOTES:**

- 1/4 T GRADATION PER CALTRANS HIGHWAY DESIGN MANUAL: PLACED PER METHOD B.
- 2 T GRADATION PER CALTRANS HIGHWAY DESIGN MANUAL: PLACED PER METHOD A.
- BFE = BASE FLOOD ELEVATION, PER FEMA FIRM PANEL 06045C1005G EFFECTIVE 09/04/2015.
- DWL = DESIGN WATER LEVEL, BFE +3 FEET EXTRA CAPACITY FOR COASTAL CLIMATE VARIABILITY. DOES NOT INCLUDE WAVE CONTRIBUTION OR RUN-UP.
- HTL = HIGH TIDE LINE DEFINED PER 33 CFR PART 328 AND IS HIGHEST ASTRONOMICAL TIDE AT ARENA COVE, CA NOAA STATION 9416841.
- STRIP ALL VEGETATION AND ORGANICS FROM SLOPE PRIOR TO PLACING ROCK SLOPE PROTECTION. TYPICAL ORGANIC LAYER THICKNESS IS 12 TO 18 INCHES (VARIES).
- BEACH SURVEY NOT COMPLETED. GRADES AND ELEVATIONS SHOWN ARE APPROXIMATE.
- ON-SITE OBSERVATIONS INDICATE THAT BEDROCK ELEVATION IS APPROXIMATELY 12 TO 18 INCHES BELOW TOP OF SAND AT APPROXIMATE LOCATION OF HTL.
- SLOPE REVETMENT SHOULD CONTINUE BELOW EXISTING GRADE UNTIL TOE OF RSP SITS ON THE SURFACE OF BEDROCK.

**B SECTION (THRU SOUTH DAM)**  
 SCALE: 1"=10'



REV	BY	DATE	DESCRIPTION
1			
2			
3			
4			
5			
6			
7			
8			
9			
10			

**SOUTH DAM IMPROVEMENT SECTIONS A & B**  
 MILL POND DAM

CALIFORNIA  
 MENDOCINO COUNTY  
 FORT BRAGG

**NOT FOR CONSTRUCTION**

DATE: 03/29/2022  
 SCALE: 1"=10'  
 DESIGNED BY: J. LEATHAM  
 DRAFTED BY: J. LEATHAM  
 CHECKED BY: M. RYAN  
 JOB NO.: 22-079-01  
 FILE: 17-031.02.dwg

**60% NOT FOR CONSTRUCTION**

PLOT DATE: Tuesday, May 10, 2022 TIME: 10:56:36 AM BY: STEPHANIE GOTTSCH

FILE: c:\bms\k\ee-pw\0207949\17-031.02.dwg

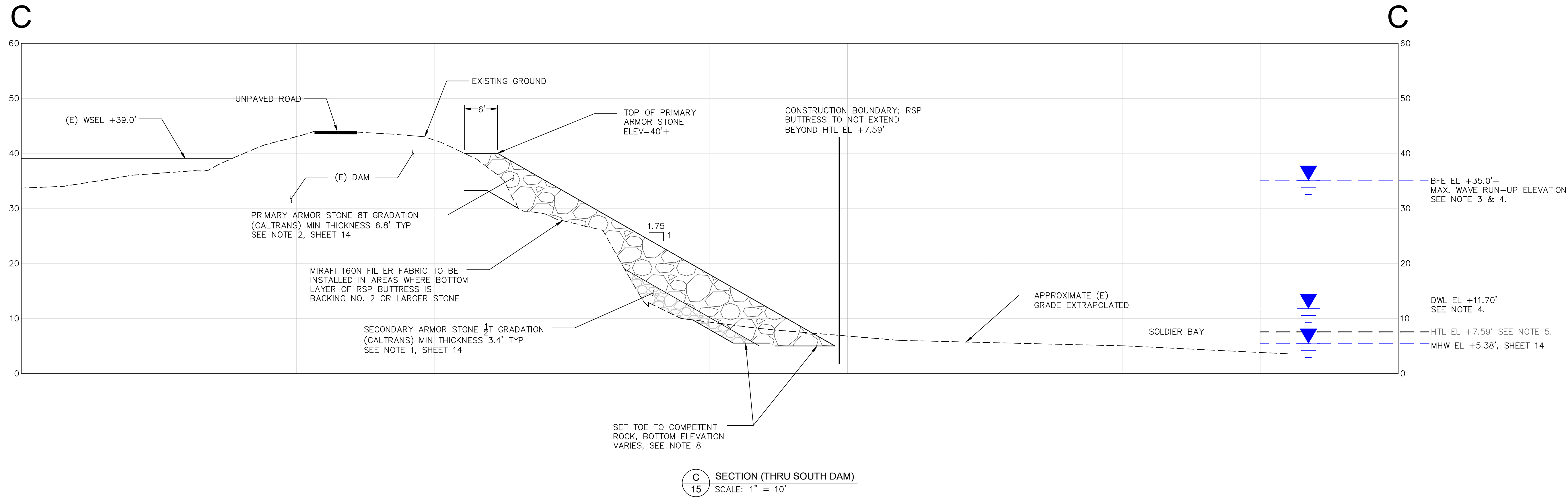

REV	BY	DATE	DESCRIPTION
1			
2			
3			
4			
5			
6			
7			
8			
9			
10			

**SOUTH DAM IMPROVEMENT SECTION C**  
**MILL POND DAM**  
 FORT BRAGG  
 MENDOCINO COUNTY  
 CALIFORNIA

**NOT FOR CONSTRUCTION**

DATE: 03/29/2022  
 SCALE: 1"=10'  
 DESIGNED BY: J. LEATHAM  
 DRAFTED BY: J. LEATHAM  
 CHECKED BY: M. RYAN  
 JOB NO.: 22-079-01  
 FILE: 17-031.02.dwg

**60% NOT FOR CONSTRUCTION**

## Enclosure 2

---

Wave Study at Mill Site and Sizing of  
Primary Layer of Rock Slope Protection (ESA 2017)



550 Kearny Street  
Suite 800  
San Francisco, CA 94108  
415.896.5900 [phone](#)  
415.896.0332 [fax](#)

[www.esassoc.com](http://www.esassoc.com)

## **memorandum**

date August 11, 2017

to Jeremie Maehr (Kennedy/Jenks)

cc Pablo Quiroga (ESA), Bob Battalio, PE (ESA)

from Jean O. Toilliez, PE (ESA)

subject Wave Study at Mill Site and Sizing of Primary Layer of Rock Slope Protection

## **INTRODUCTION AND SUMMARY**

This brief technical memorandum summarizes the results of a breaking wave height calculation and rock size assessment performed as part of the Wave Study at Mill Site project.

### **Project Location**

We understand that the Mill Pond Dam is a jurisdictional dam in California. Further, past engineering assessments have shown that some repairs and/or upgrades are necessary, partly because the structure is an approximately 140-year old facility.

### **Context**

DSOD has indicated that corrective actions are needed to stabilize the dam embankment. Some of these actions include installation of a buttress for the Crib Wall section of the dam and associated erosion protection to the section of the dam that is exposed to wave and tidal action. To that end, this study focused on the assessment of the minimum rock armor sizing required as part of the installation of a Rock Slope Protection (RSP) on the West end of Pond 8. ESA was asked to provide an assessment of stable rock size for the rock revetment proposed by others. The stability assessment is based on ocean wave loading.

### **Scope of Work**

The objectives of the present wave study were to assess the following quantities:

- Design water level (1%-return frequency, excluding tsunami effects);
- Design wave height;
- Gradation of the primary rock layer (“face stone”) in the Rock Slope Protection (RSP);



Given a set of assumptions, provided to ESA.

## Design Guidelines

The primary methodology retained for the design of the RSP to be installed at the project site is available in Chapter 870 of the Highway Design Manual, published by the California Department of Transportation (“Caltrans”), see Ref. [01]. Supplemental methods were used to support the findings obtained from the Caltrans formulation.

## Summary of Findings

The results generated as part of this study are summarized below:

**Table 1 Summary of findings.**

Design Parameter	Value	Notes
<b>Design still water level</b>	12.0 ft-NAVD88	1%-Annual Exceedance Probability, which includes an allowance for long-term sea level variations, and excludes tsunami effects
<b>Design wave height at toe of structure</b>	8.2 ft	Breaking wave height, 1%-Annual Exceedance Probability
<b>Primary layer gradation (“face stone”)</b>	Caltrans 4T	Per Caltrans Highway Design Manual, Chapter 870

## BATHYMETRY AND TOPOGRAPHY

We used three bathymetry and topography datasets to estimate slope characteristics in the vicinity of the RSP. These sources are as follows:

- NOAA, 2012. Tsunami Inundation Gridding Project: Fort Bragg, CA 1/3 rc-second Tsunami Inundation DEM
- NOAA, 2013. Coastal California TopoBathy Merge Project
- California Coastal Conservancy, 2010. 2009-2011 California Coastal Conservancy Coastal Lidar Project

Our assessment resulted in an estimated local beach slope ranging from approximately 12H:1V to 14H:1V; the estimated slope of the sea-bed within the cove is approximately 1250H:1V.

## DESIGN WATER LEVELS

### Data Sources

Water levels are assessed based on the nearest available and quality-controlled NOAA tidal stations, namely the Arena Cove, CA, Point Reyes, CA, and San Francisco, CA. The nearest reliable tidal station is located approximately 35 miles South from the project site. All data sources were leveraged as explained in the sections that follow.

## Tidal Datums

Tidal datums from the Arena Cove (NOAA Tide Station 9416841) were used to assess water levels at the project site. A summary of tidal datums at that station is shown hereafter.

**Table 2 Tidal datums at Arena Cove, CA. Source: NOAA**

Abbreviation	EL [ft-STND]	EL [ft-NAVD88]	Description
<b>Maximum</b>	37.6	8.53	Highest Observed Water Level
<b>HAT</b>	36.66	7.59	Highest Astronomical Tide
<b>MHHW</b>	34.81	5.74	Mean Higher-High Water
<b>MSL</b>	32.08	3.01	Mean Sea Level
<b>MLLW</b>	28.94	-0.13	Mean Lower-Low Water
<b>NAVD88</b>	29.07	0	North American Vertical Datum of 1988
<b>LAT</b>	26.68	-2.39	Lowest Astronomical Tide
<b>Minimum</b>	26.3	-2.77	Lowest Observed Water Level

## High Tide Line

For the purpose of this study, the HTL is defined as 7.59 ft-NAVD88.

## Still Water Level

According to calculations performed by NOAA using data collected at Tidal Station 9416841, at the 1% return frequency, the still water level (SWL) reads approximately 8.7 ft-NAVD88. Independent calculations based on NOAA-provided water levels indicate a return elevation of 8.8 ft-NAVD88. These calculations incorporate water levels measured continuously between 1990 and 2017. Longer water records in San Francisco (station 9414290, with records from 1900-2017) and Point Reyes (station 9415020, with records ranging 1975-2017) were also assessed. According to NOAA calculations, the 1% SWL at San Francisco reads 8.7 ft; and at Point Reyes, 9.0 ft. The latter value was retained for design.

## FEMA Base Flood Elevation

According to the most recent FEMA FIRM product (06045C1005G, effective on 07/18/2017), the project is located in Zone VE, where the BFE reads 35 ft-NAVD88. We note that wave parameters at the nearest coastal transect (transect 28) were not calculated or published by FEMA at the project location (see Flood Insurance Study Number 06045CV001B issued on July 18, 2017). The BFE does not incorporate contingency for anticipated sea level rise.

## Wave Setup

Wave setup is the additional elevation of the water level due to the effects of transferring wave-related momentum to the surf zone. Momentum is transferred from winds to waves in the wave generating area (usually

in deep water for the Pacific Coast) and then is conveyed to shore by the waves similar to the manner that waves transport energy from the generating area to shore.

A main difference between energy and momentum is that energy is dissipated in the surf zone whereas momentum is transferred to the water column. This transfer is equivalent to a shoreward-directed “push” on the water column that causes a tilt of the water surface. The wave setup is small and negative seaward of the surf zone (setdown) and begins to rise in the surf zone due to the transfer of momentum. As a result, effective water levels on a sloping beach can be significantly higher than the still water levels recorded by a tidal gauge.

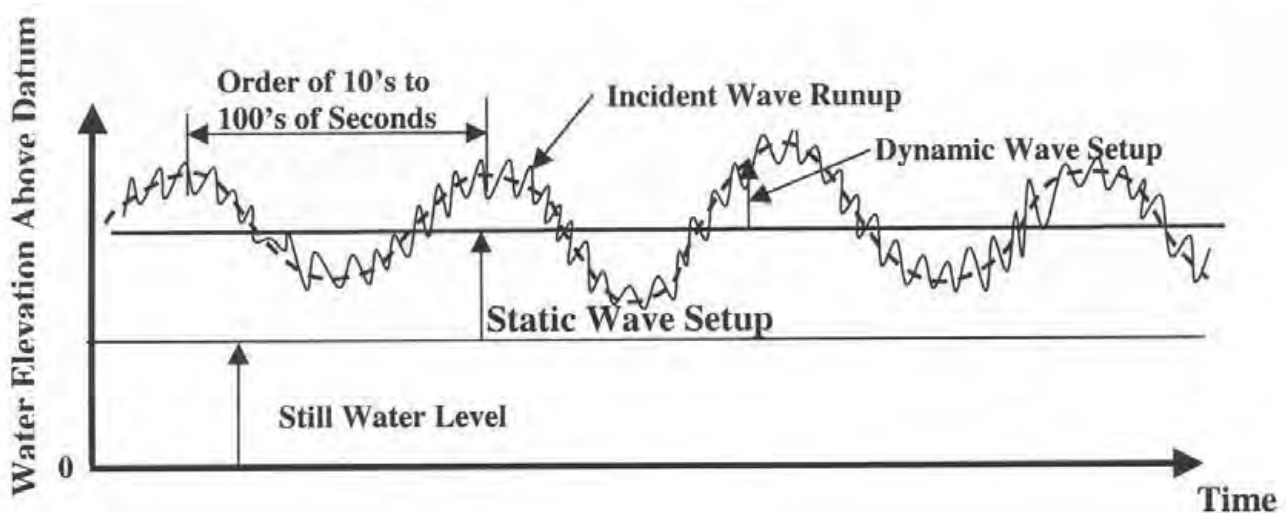

**Figure 1** Definitions of Static and Dynamic Wave Setup and Incident Wave Runup. Reproduced from [04].

Due to the presence of a shallow cove at Soldier Bay two methods of estimated wave setup were used:

- a parametric approach presented in 2005 FEMA flood mapping guidelines [04], namely the Direct Integration Method (DIM). Consistent with FEMA guidelines, we have elevated steady water levels using twice the standard deviation of the dynamic wave setup computed according to the DIM method. We verified this estimation using the XBeach model (see below), and found this approach to be conservative.
- and a direct numerical simulations performed using a 1-dimensional model, XBeach, forced with boundary conditions obtained from the nearest available Wave Information Study synthetic wave gauge.

Our calculations were as follows:

- In implementing the DIM approach, we approximated the slope in the cove by the average change in bed elevation at the start of the flat reef (mouth of the cove) to the anticipated RSP toe location. We computed the standard deviation of the dynamic wave setup component using wave conditions obtained in XBeach, at a point located at the breaking location of offshore waves, immediately outside of Soldier Bay.
- The XBeach model computes wave setup numerically, which we extracted at the toe location of the RSP. Wave spectral parameters used in XBeach were adjusted to reflect a narrow spectrum, characteristics of

spatially coherent, long swell waves reaching the site. The value for the wave setup reported by XBeach was inferred by measuring the maximum positive difference between the effective water level at the toe of the RSP, and the still water level, during a 3-hour storm. The synthesized storm utilized the 1%-return level wave heights provided by the nearest WIS data buoy.

The results of the analysis are presented in Table 3. In our calculations, we have used both values to assess a range of maximum breaking wave height.

**Table 3 Total wave setup at project location.**

Component	FEMA (DIM) Setup	XBeach Setup
Dynamic setup, $\sigma$	1.4 ft	N/A
Wave setup, as $2\sigma$	<b>3.2 ft</b>	<b>1.8 ft</b>

## Coastal Climate Variability

### Guidance

According to a 2012 report by the NRC (see Ref. [02]), the following values are recommended to adjust for future water levels, as shown in Table 4. A central projection of 3 ft was retained to account for reasonably anticipated variations in mean sea levels by 2100. The value retained for design is highlighted in blue in the Table 4.

ESA understands that the RSP will be part of a maintenance program throughout the design life of the structure, and that as such, adequate measures will be taken if static variations in mean sea level exceed the value retained for design.

**Table 4 Coastal climate variations increase in feet according to NRC from year 2000 to year 2100. Source: NRC (2012).**

Year	Central projection [ft]	Central range [ft]		Lower and upper bounds [ft]	
2000	0.00	0.00	0.00	0.00	0.00
2030	0.47	0.31	0.64	0.14	0.97
2050	0.92	0.62	1.22	0.40	1.99
2100	<b>3.02</b>	2.18	3.85	1.39	5.46

## Summary of Water Levels

A summary of extreme water levels and tidal datums were extracted from charts provided by NOAA at the Noyo Harbor, CA and Arena Cove, CA, tidal stations, and FEMA maps. Long-term design water levels were assessed at the 1%-annual exceedance probability level, and adjusted for long-term coastal variability using projections from the NRC. A summary of design water level is shown in Table 5 below.

**Table 5 Summary of water levels at the project site. Sources: NOAA, NRC, FEMA.**

Abbreviation	EL [ft-NAVD88]	Description
1% WL (design)	12.0	Water level at the 1% level, design case, with 3 ft allowance for future variations in mean sea level, and excluding contributions from tsunamis or wave setup

## RSP CHARACTERISTICS AND ASSUMPTIONS

The results presented herein regarding the size and characteristics of the primary rock layer of the RSP are contingent upon a series of design assumptions of the RSP structure, communicated to ESA by others. These assumptions are listed below.

### RSP Toe Location

Per drawings provided to ESA, the maximum permissible seaward extent of the toe of the RSP will coincide with HTL.

### Scour Depth

Based on exploration with hand tools on the beach, competent bedrock, and therefore scour depth  $d_s$  is approximately 18 inches below the existing grade. Note that lower bedrock would potentially allow scour to progress deeper and thereby allow a larger depth-limited wave with higher loading (incrementally larger required rock size). ESA has not evaluated the potential for scour of the bedrock, which is likely a wave-cut platform overlain by littoral sediments.

### Design Water Depth

The design water depth is the difference between the design water elevation and minimum elevation at the toe of the RSP, including scour depth. In this case, the design water depth  $d_w$  is 5.8 ft.

### RSP Slope

Per drawings provided to ESA, the RSP slope is 1.75H:1V.

### Specific Gravity

In our calculations, we have assumed that the specific gravity of the armor rock material is approximately 2.65 (per California Test 206 requirements). The actual rock density should be equal to this value or higher.

## WAVE ASSESSMENT

### Approach

According to Caltrans methodology (see Appendix B), the design wave is the minimum value between the maximum supported wave height at the toe of the RSP, and the 20-year significant wave height obtained from

spectral wave transformation models (for instance). In this case, given the context of this project, we have conservatively estimated the maximum supported wave height at the toe of the RSP under 1%-return frequency storm conditions (using wave height). Note that the maximum breaking height was not assessed during a tsunami event, as the combined equivalent return period would be prohibitively large. To supplement this analysis, we conducted a limited wave transformation assessment to independently verify the consistency of our findings.

## Maximum Supported Wave Height

The maximum supported wave height in shallow water is directly conditioned by the local water depth at the toe of a rock revetment. The maximum supported wave height represents an upper bound of the maximum possible wave height at that location. The Highway Design Manual, Chapter 870 [01] introduces the maximum supported wave height as an indirect method of assessing wave conditions at a particular site, given a design water elevation (and depth), in absence of a more comprehensive wave hindcast or re-analysis. Caltrans method provides recommendation for selecting a design wave height that is the smallest value between the maximum breaking wave height, and the significant wave height.

In addition to the method presented in [01], we also estimated the breaker index using the Goda, 2010 formulation (see Ref.[03]), which according to the authors is an improved version of the method proposed in [01] for gentle beach slopes. For both methods, we used the asymptotic value of the breaker index to estimate the maximum wave height capable of occurring at the toe of the breakwater under design conditions. The estimates of the breaking indices we obtained are as follows:

- According to Goda, 2010 method, using a slope value representative of the cove, the breaker index reads 0.8;
- Per Caltrans Figure 873.2C, using a slope value representative of the cove, we obtained a breaker index of approximately 0.84 (using the  $m = 1:100$  line).

## Design Water Depth

Per the results of the previous section, and using a SWL of 9.0 ft-NAVD88, the design water depth at the toe of the structure is estimated to range from 7.7 ft (smaller wave setup) to 9.2 ft (larger wave setup).

## Design Wave Height

The results of the analysis showed that the maximum breaking wave height at the toe of the breakwater, for the range of slopes extracted at the project location, and including the contribution of total wave setup from large offshore waves, ranges as follows:

- User Caltrans breaker index, the maximum breaking wave height ranges from 6.9 to 8.2 ft
- Using the Goda, 2010 formulation, the maximum breaking wave height ranges from 6.2 to 7.3 ft.

Numerical wave simulations performed using 1-dimensional wave transformation models suggest that these values are conservative, with simulations performed in XBeach resulting in a significant wave height of approximately 7 ft at the 1%-level.

## ROCK SLOPE PROTECTION (RSP)

### Design Standards

In addition to implementing the design equations contained within Caltrans Highway Design Manual [01], verifications of the sizing requirements were performed against other industry-standard rock sizing equations, including the Hudson (1974) and Van der Meer (1988) formulae available in the Coastal Engineering Manual (CEM), published by the USACE [05].

### Primary Rock Layer (“Face Stone”) Gradation

#### Gradation

According to the methodology described in the Chapter 870 of the Highway Design Manual, the gradation of the primary rock layer to be placed at the RSP under the assumptions discussed in this report is Caltrans 4T.

#### Methods Implemented

Specifically, using an 8.2 ft breaking wave height, the following minimum median rock weights are obtained:

Methodology	Median rock weight
<b>Caltrans (Chapter 870 of Highway Design Manual)</b>	3 tons
<b>Hudson (1974) method, using the H10 formulation</b>	3.3 tons
<b>Van der Meer method, using an 18s peak period</b>	3.4 tons
<b>Recommended median rock weight, given as standard Caltrans gradation</b>	<b>4T (4 tons)</b>

## REFERENCES CITED

- [01] Caltrans. 2014. “Highway Design Manual - Chapter 870 - Channel and Shore Protection - Erosion Control.” Sacramento, Calif.: California Department of Transportation.
- [02] NRC. 2012. Sea-Level Rise for the Coasts of California, Oregon, and Washington: Past, Present, and Future. National Research Council. The National Academies Press.  
[http://www.nap.edu/openbook.php?record\\_id=13389](http://www.nap.edu/openbook.php?record_id=13389).
- [03] Liu, Yu, Xiaojing Niu, and Xiping Yu. 2011. “A New Predictive Formula for Inception of Regular Wave Breaking.” *Coastal Engineering* 58 (9): 877–89. doi:10.1016/j.coastaleng.2011.05.004.
- [04] FEMA. 2004. “Final Draft Guidelines for Coastal Flood Hazard Analysis and Mapping for the Pacific Coast of the United States. A Joint Project by FEMA Region IX, FEMA Region X, FEMA Headquarters.” Oakland, CA: Federal Emergency Management Agency.
- [05] USACE. 2011. “Coastal Engineering Manual. EM 1110-2-1100 (Part VI).” EM 1110-2-1100. Vicksburg, MS: US Army Corps of Engineers. Engineer Research and Development Center.

- [06] USACE. 1991. "Hydraulic Design of Flood Control Channels. EM 1110-2-1601." Engineer Manual EM 1110-2-1601. Washington, DC 20314-1000: U.S. Army Corps of Engineers.



## Enclosure 3

---

Draft Remedial Action Plan – Operable Unit E, Former Georgia-Pacific  
Wood Products Facility Fort Bragg, California (Kennedy Jenks 2020)

DRAFT  
Remedial Action Plan –  
Operable Unit E  
Former Georgia-Pacific  
Wood Products Facility  
Fort Bragg, California

14 October 2020

Prepared for  
Georgia-Pacific LLC  
133 Peachtree Street NE  
Atlanta, Georgia 30303

© Georgia-Pacific LLC 2015  
KJ Project No. 1665018\*20

## Certification Page

---

PE Stamp and Signature

By: Jeremie Maehr  
Principal

# Table of Contents

---

<i>Certification Page</i> .....	<i>i</i>
<i>List of Tables</i> .....	<i>iii</i>
<i>List of Figures</i> .....	<i>iii</i>
<i>List of Appendices</i> .....	<i>iv</i>
<i>Acronyms and Abbreviations</i> .....	<i>v</i>
<i>Executive Summary</i> .....	<i>i</i>
Section 1: Introduction .....	1
1.1 Regulatory Framework .....	2
1.2 Objectives .....	3
1.3 Report Organization .....	3
Section 2: Background Information.....	5
2.1 Site Setting .....	5
2.1.1 Geology and Hydrogeology.....	5
2.1.1.1 Regional.....	5
2.1.1.2 OU-E Specific .....	6
2.1.1.3 OU-C and OU-D Specific (Riparian AOI, IRM AOI, and West of IRM AOI) .....	6
2.1.2 Hydrology .....	6
2.1.2.1 Regional.....	6
2.1.2.2 Site Groundwater Occurrence and Hydraulic Properties .....	7
2.1.2.3 Groundwater Use.....	7
2.1.3 Surface Water Hydrology .....	7
2.1.4 Biological Setting.....	8
2.1.5 Cultural Resources.....	9
2.2 General Site History of OU-E .....	9
2.2.1 OU-E Areas of Interest.....	11
2.2.1.1 AOIs with No Further Action Determination during Remedial Investigation.....	11
2.2.1.2 AOIs Recommended for NFA .....	12
2.2.1.3 AOIs Approved for NFA in the RACR .....	12
2.2.1.4 AOCs Evaluated in the Feasibility Study .....	12
2.2.1.5 Southern Ponds (Ponds 1-4) .....	13
2.2.1.6 Pond 7 .....	13
2.2.1.7 North Pond and Pond 6 .....	13
2.2.1.8 Pond 8 .....	14
2.2.1.9 OU-E Groundwater .....	14

Table of Contents (cont'd)

---

2.3	Conceptual Site Model .....	16
2.3.1	Sources of Chemicals .....	16
2.3.2	Chemicals of Interest .....	16
2.3.3	Fate and Transport.....	16
2.4	Previous Remedial Investigations .....	17
2.4.1	Environmental Investigations .....	17
2.4.1.1	Lead-Based Paint Investigation .....	17
2.4.1.2	Phase I Environmental Site Assessment.....	17
2.4.1.3	Phase II Environmental Site Assessment.....	18
2.4.1.4	2004 Additional Site Assessment .....	18
2.4.1.5	2005 Additional Site Assessment .....	18
2.4.1.6	Pond Sediment Investigations .....	18
2.4.1.7	Groundwater Monitoring .....	20
2.4.2	Biological Assessment .....	21
2.4.3	Remedial Investigations .....	22
2.4.4	OU-C and OU-D IRM and West of IRM Soil and Groundwater Investigations and Risk Assessment .....	23
2.5	Remedial Actions .....	23
2.5.1	Interim Remedial Measures .....	23
2.5.2	2017 Remedial Actions .....	24
2.6	Baseline Risk Assessment.....	24
Section 3:	Remedial Action Objectives.....	27
3.1	Applicable or Relevant and Appropriate Requirements .....	27
3.2	Remedial Action Objectives .....	28
3.3	Chemical Specific Remedial Goals .....	28
Section 4:	Remedial Alternatives and Selected Remedial Actions .....	30
4.1	Summary of Evaluated Remedial Alternatives and Recommendations .....	30
4.1.1	Evaluation Criteria.....	32
4.1.1.1	Threshold Screening Criteria .....	32
4.1.1.2	Balancing Criteria .....	32
4.1.1.3	Modifying Criteria.....	34
4.1.1.4	Other Criteria .....	34
4.1.2	Ponds 1-4 (Southern Ponds).....	34
4.1.3	Pond 7.....	35
4.1.4	North Pond and Pond 6.....	36
4.1.5	Pond 8.....	37
4.1.6	Groundwater .....	39
Section 5:	Reporting and Public Participation.....	41
5.1	Reporting.....	41

## Table of Contents (cont'd)

---

5.2	Public Participation.....	41
5.3	Schedule .....	41
Section 6:	References.....	42

## List of Tables

---

2-1	Area of Interest (AOI) Status and Proposed Remedial Action
2-2	Exposure Point Concentrations for COCs in Each AOI with Proposed Remedial Action Summary of Risk Drivers for Soil in OU-E
3-1	Applicable or Relevant and Appropriate Requirements (ARARs) and "To be Considered" (TBC) Factors
3-2	OU-E Draft Site-Specific Cleanup Goals for Sediment, Soil, and Groundwater
4-1	Preliminary and Detailed Screening of Process Options - Soil
4-2	Preliminary and Detailed Screening of Process Options - Sediment
4-3	Preliminary and Detailed Screening of Process Options - Groundwater
4-4	Comparison of Remedial Alternatives
4-5	Remedial Alternative Recommendations Summary

## List of Figures

---

1-1	Site Location Map
1-2	Operable Units Location Map
1-3	OU-E Area of Interest Map and Associated Features
1-4	OU-E Terrestrial AOIs and Associated Features
1-5	OU-E Soil and Sediment Status
1-6	OU-E Groundwater Status
1-7	Drainage Areas and Discharge Points
1-8	Construction of Ponds 1-4
1-9	Historical Extent of Pond 8
2-1	Future Land Development
2-2	Wetlands and Other Wet Environmentally Sensitive Habitat Area-Northern
2-3	Wetlands and Other Wet Environmentally Sensitive Habitat Area-Central
2-4	Wetlands and Other Wet Environmentally Sensitive Habitat Area-Southern

## Table of Contents (cont'd)

---

- 2-5 Geology Map
- 2-6 Monitoring Well Network for Lowlands and IRM and West of IRM AOIs
- 2-7 Powerhouse and Fuel Barn AOI and Pond 8 Fill Area AOI – Soil, Sediment, Groundwater and Surface Water Sampling Locations
- 2-8 Southern Ponds – Sediment and Surface Water Sampling Locations
- 2-9 Pond 5 and Pond 9 – Sediment and Surface Water Sampling Locations
- 2-10 Pond 8 Sediment Probe Transect Overview
- 2-11 Pond 8 Sediment Probe Transect – Arsenic Results: Sheet 1
- 2-12 Pond 8 Sediment Probe Transect – Arsenic Results: Sheet 2
- 2-13 Pond 8 Sediment Probe Transect – Arsenic Results: Sheet 3
- 2-14 Pond 8 Sediment Probe Transect – Dioxin Results: Sheet 1
- 2-15 Pond 8 Sediment Probe Transect – Dioxin Results: Sheet 2
- 2-16 Pond 8 Sediment Probe Transect – Dioxin Results: Sheet 3
- 2-17 Water Treatment and Truck Dump, Compressor House and Lath Building, and Sawmill #1 AOIs – Soil, Sediment and Surface Water Sampling Locations
- 2-18 Arsenic Concentrations in Sediment – Ponds 6, 7, 8 and North Pond
- 2-19 Dioxin (2,3,7,8-TCDD) TEQ Concentrations in Sediment – Ponds 6, 7, 8 and North Pond
- 2-20 Arsenic Concentrations in Sediment – Southern Ponds
- 2-21 Dioxin (2,3,7,8-TCDD) TEQ Concentrations in Sediment – Southern Ponds
- 2-22 Dioxin (2,3,7,8-TCDD) TEQ Concentrations in Sediment – Riparian Areas
- 2-23 BHHERA Sampling Locations – Ponds 6, 7, 8 and North Pond
- 2-24 BHHERA Sampling Locations – Ponds 5 and 9
- 2-25 BHHERA Sampling Locations – Southern Ponds
- 2-26 BHHERA Sampling Locations – Riparian
- 2-27 Lowland Terrestrial Conceptual Site Model
- 2-28 Aquatic Area Conceptual Site Model

## List of Appendices

---

- A Administrative Record List

## Acronyms and Abbreviations

---

µg/L	micrograms per liter
AOC	area of concern
AOI	area of interest
ARAR	applicable, relevant, and appropriate requirement
AST	aboveground storage tank
Basin Plan	Water Quality Control Plan
bgs	below ground surface
BHHERA	Baseline Human Health and Ecological Risk Assessment
bss	below sediment surface
CCC	California Coastal Commission
CERCLA	Comprehensive Environmental Recovery, Cleanup, and Liability Act
CEQA	California Environmental Quality Act
CFR	40 Code of Federal Regulations
City	City of Fort Bragg
COC	contaminants of concern
COI	chemical of interest
COPC	constituent of potential concern
CPM	Comprehensive Monitoring Program
CRAM	California Rapid Assessment Method
CSM	conceptual site model
cy	cubic yard
dioxins	polychlorinated dibenzo-p-dioxin
DSOD	California Division of Safety of Dams
DTSC	California Department of Toxic Substances Control
ELCR	excess lifetime cancer risks
EPA	U.S. Environmental Protection Agency
EPC	exposure point concentration
ERA	ecological risk assessment
ESA	Environmental Site Assessment
ESHA	environmentally sensitive habitat area
EU	exposure unit
FS	Feasibility Study
ft/ft	feet per foot
furans	polychlorinated dibenzofuran
Georgia-Pacific	Georgia-Pacific LLC
GW O&M Plan	Groundwater Operation and Maintenance Plan
HDPE	high-density polyethylene
HHRA	human health risk assessment
HSC	California Health and Safety Code
HQ	Hazard Quotient
IARAP	Interim Action Remedial Action Plan
IRM	Interim Remedial Measure
Kennedy Jenks	Kennedy/Jenks Consultants, Inc.



## Acronyms and Abbreviations (cont'd)

---

LBP	lead-based paint
LUC	Land Use Covenant
MES	Mobile Equipment Shop
mg/kg	milligrams per kilogram
MNA	monitored natural attenuation
NAVD 88	Northern American Vertical Datum of 1988
NCP	National Contingency Plan
NFA	no further action
O&M	operation and maintenance
Order	Site Investigation and Remediation Order Docket No. HAS-RAO 06-07-150
ORM	oxygen-releasing material
OU-E	Operable Unit E
PAH	polycyclic aromatic hydrocarbon
PCB	polychlorinated biphenyl
pg/g	picograms per gram
ppm	parts per million
PSL	preliminary screening level
RAA	remedial action area
RACR	Remedial Action Completion Report
RAO	remedial action objective
RAP	Remedial Action Plan
RAW	Remedial Action Workplan
RBTL	risk-based-target levels
RDIP	Remedial Action Implementation Plan
RI	remedial investigation
RWQCB	Regional Water Quality Control Board
sf	square feet
SFRWQCB	San Francisco Bay Regional Water Quality Control Board
site	Georgia-Pacific Wood Products Facility, 90 West Redwood Avenue, Fort Bragg, Mendocino County, California
Site-Wide RAWP	Site-Wide Risk Assessment Work Plan
SMP	Soil Management Plan
SVOC	semi-volatile organic compound
TBC	to-be-considered
TEQ	toxic equivalent
TOC	total organic carbon
TPH	total petroleum hydrocarbons
TPHd	total petroleum hydrocarbon as diesel
TPHg	total petroleum hydrocarbon as gasoline
TPHmo	total petroleum hydrocarbon as motor oil
UCL	upper confidence limit
ULC	Union Lumber Company
USACE	U.S. Army Corps of Engineers
UST	underground storage tank

## Acronyms and Abbreviations (cont'd)

---

VOC	volatile organic compound
WEA Report	Wetland Establishment Area Annual Report and As-Built Conditions for Georgia-Pacific Fort Bragg Mill Site
WQO	water quality objective
WRA	WRA Environmental Consultants

## Executive Summary

---

This Remedial Action Plan (RAP) was prepared by Kennedy/Jenks Consultants, Inc. (Kennedy Jenks) on behalf of Georgia-Pacific LLC (Georgia-Pacific) for Operable Unit E (OU-E) at the former Georgia-Pacific Wood Products Facility located at 90 West Redwood Avenue in Fort Bragg, Mendocino County, California (site), as shown on Figure 1-1. This RAP was prepared as required by the California Department of Toxic Substances Control (DTSC) under Site Investigation and Remediation Order Docket No. HAS-RAO 06-07-150 (Order). The purpose of this RAP is to comply with the provisions of section 25356.1 and to describe remedial actions planned for features within OU-E.

The 415-acre site is located west of Highway 1 along the Pacific Ocean coastline and is bounded by Noyo Bay to the south, the City of Fort Bragg (City) to the east and north, and the Pacific Ocean to the west (Figure 1-1). Union Lumber Company began sawmill operations at the site in 1885. Georgia-Pacific acquired the site in 1973. Sawmill operations at the site included lumber production and power generation by burning residual bark and wood. Georgia-Pacific ceased operations on 8 August 2002. Much of the equipment and structures associated with the sawmill operations have been removed.

OU-E is one of five operable units on the site (Figure 1-2) and consists of approximately 12 acres of man-made ponds and seasonal wetland areas and 45 terrestrial acres divided into eight areas of interest (AOIs). This RAP addresses sediment in Pond 6, Pond 7, Pond 8, and the North Pond and groundwater in the Interim Remedial Measure (IRM) AOI, West of IRM AOI, and MW-4.1 in the Powerhouse and Fuel Barn AOI.

DTSC has determined through investigation and remediation that soil in the Water Treatment and Truck Dump AOI, Sawmill #1 AOI, Compressor House and Lath Building AOI, Powerhouse and Fuel Barn AOI, Pond 8 Fill Area AOI, IRM AOI, West of IRM AOI, and Riparian AOI require No Further Action (NFA) because the COCs in soil meet unrestricted cleanup goals. Therefore, these AOIs are not addressed in this OU-E RAP.

OU-E was divided into 13 AOIs based on historical use and data derived from previous investigations, six of which have been evaluated as part of two larger AOIs (Figures 1-3 through 1-6):

1. **OU-E Lowland Terrestrial Soil AOI:** approved for no further action (NFA) (DTSC 2018)
  - a. Water Treatment and Truck Dump AOI
  - b. Sawmill #1 AOI
  - c. Compressor House and Lath Building AOI
  - d. Powerhouse and Fuel Barn AOI

2. **Pond 8 Fill Area AOI:** approved for NFA (DTSC 2013b)
3. **Pond 8 Area of Concern (AOC):** evaluated in OU-E Feasibility Study (FS)
4. **Pond 6 and North Pond AOC:** evaluated in OU-E FS
5. **Pond 7 AOC:** evaluated in OU-E FS
6. **Southern Ponds AOC:** evaluated in OU-E FS
7. **Ponds 5 and 9 AOI:** recommended for NFA
8. **OU-E Groundwater AOC:** evaluated in OU-E FS
  - a. West of IRM AOI
  - b. IRM AOI
9. **Riparian AOI:** approved for NFA (DTSC 2018).

Aquatic areas include Ponds 1 through 9 and the North Pond. Terrestrial areas include the Water Treatment and Truck Dump AOI, Sawmill #1 AOI, Compressor House and Lath Building AOI, Powerhouse and Fuel Barn AOI, and Pond 8 Fill Area AOI as well as the Riparian AOI, IRM AOI and West of IRM AOI (Figure 1-3), which were transferred from operable units C and D. Predominant industrial features in OU-E were related to power production, milling of timber, water treatment, management of fly ash, and fuel storage. The ponds were constructed for operational purposes, including management of wastewater from site operations, providing a source of water for firefighting, and use as a log pond. Ponds 1 – 4, 6, 7, and the North Pond were constructed during operation of the Mill between 1952 and 1996 (see Figure 1-8). Pond 8 was constructed during the initial development of the Mill Site around 1885 as the log pond (Figure 1-9). Currently, OU-E is vacant, there are no structures or uses in the terrestrial area, and the primary use of the aquatic areas, specifically Pond 8, is to provide stormwater management for the City prior to discharge to the ocean. The central section of the Coastal Trail was constructed through a portion of OU-E and is separated from the Mill Site with property line fencing that is marked with warning signs. The foreseeable future use of OU-E is as continued stormwater management facilities, parkland, and recreational trail development. Some commercial land use may occur in Parcel 5, depending on the outcome of the City planning process.

The contaminants of concern (COCs) and environmental media for the five AOCs evaluated in the OU-E FS and discussed in this RAP are presented below:

- **Southern Ponds (Ponds 1-4) AOC:** Aquatic sediment (dioxins, arsenic)
- **Pond 7 AOC:** Aquatic sediment (dioxins, arsenic, barium)
- **North Pond and Pond 6 AOC:** Aquatic sediment (dioxins, arsenic)
- **Pond 8 AOC:** Aquatic sediment (dioxins, arsenic)

- **OU-E Groundwater AOC**

- IRM and West of IRM AOIs: Groundwater [total petroleum hydrocarbon as diesel (TPHd), total petroleum hydrocarbon as gasoline (TPHg)]
- OU-E Lowlands AOI: Groundwater (barium).

A summary of the proposed remedial action alternative, as well as other remedial alternatives considered, is presented below:

**Southern Ponds (Ponds 1-4) AOC:** Remedial alternatives evaluated in the OU-E FS for aquatic sediment in Ponds 1-4 included the following: 1) No Action; 2) Institutional Controls (containment, land use controls, sediment management, and long-term operations and management); 3) Construction of an upland vegetated cover to cover each individual pond to restrict exposure of potential receptors to affected media by limiting potential direct contact with affected sediment or infiltration of water; 4) Excavation and offsite disposal of sediment in Ponds 1-4; and 5) Construction of a vegetated wetland cover to cover each individual pond to restrict exposure of potential receptors to affected media by limiting potential direct contact with affected sediment or infiltration of water.

Based on the analysis presented in the OU-E FS, institutional controls were selected as the preferred alternative for the Southern Ponds AOC. Although it is associated with a slightly lower reduction of toxicity, mobility, and volume, institutional controls provide adequate control of potential exposure pathways for future receptors. The benefits of a physical cover were offset by the effort and disruption required for implementation and potentially regular operation and maintenance (O&M). The benefits of excavation and disposal were offset by the effort and disruption required for implementation and the need to transport and dispose the sediment at a landfill. The cost difference between the alternatives was not justified by limited benefits of the vegetated soil cover or excavation and disposal alternatives. Additionally, sediment COC concentrations and bioavailable fractions were significantly reduced by sediment removal performed in 2017 and are expected to continue to decline naturally through existing biological and geochemical processes.

**Pond 7 AOC:** Remedial alternatives evaluated in the OU-E FS for aquatic sediment in Pond 7 included the following: 1) No Action; 2) Institutional Control / Containment (containment, land use controls, sediment management, and long-term operations and management); 3) Construction of an upland vegetated cover to cover the pond to restrict exposure of potential receptors to affected media by limiting potential direct contact with affected sediment or infiltration of water; 4) Excavation and offsite disposal of sediment; and 5) Construction of a vegetated wetland cover to cover the pond to restrict exposure of potential receptors to affected media by limiting potential direct contact with affected sediment or infiltration of water.

Based on the analysis presented in the OU-E FS, institutional control / containment were selected as the preferred alternative for Pond 7 aquatic sediment. Although it was associated with a slightly lower reduction of toxicity, mobility, and volume, institutional control / containment provide adequate control of potential exposure pathways for future receptors. The benefits of a physical cover were offset by the effort and disruption required for implementation and potentially regular O&M, as well as the disturbance of the newly-created wetland establishment area. The benefits of excavation and disposal were offset by the effort and disruption required

for implementation and the need to transport and dispose the sediment at a landfill. The cost difference between the alternatives was not justified by limited benefits of the vegetated soil cover or excavation and disposal alternatives. Additionally, sediment COC concentrations and bioavailable fractions were significantly reduced by sediment removal performed in 2017 and are expected to continue to decline naturally through existing biological and geochemical processes.

**North Pond and Pond 6 AOC:** Remedial alternatives evaluated in the OU-E FS for aquatic sediment in Pond 6 and the North Pond included the following: 1) No Action; 2) Institutional Control / Containment (containment, land use controls, sediment management, and long-term operations and management); 3) Construction of an upland vegetated cover to cover each pond to restrict exposure of potential receptors to affected media by limiting potential direct contact with affected sediment or infiltration of water; 4) Excavation and offsite disposal of sediment; and 5) Construction of a vegetated wetland cover to cover each pond to restrict exposure of potential receptors to affected media by limiting potential direct contact with affected sediment or infiltration of water.

Based on the analysis presented in the OU-E FS, institutional control / containment were selected as the preferred alternative for aquatic sediment in the North Pond and Pond 6. Although it was associated with a slightly lower reduction of toxicity, mobility, and volume, institutional control / containment provide adequate control of potential exposure pathways for future receptors. The benefits of a physical cover were offset by the effort and disruption required for implementation and potentially regular O&M. The benefits of excavation and disposal were offset by the effort and disruption required for implementation and the need to transport and dispose the sediment at a landfill. The cost difference between the alternatives was not justified by limited benefits of the vegetated soil cover or excavation and disposal alternatives. Additionally, sediment COC concentrations and bioavailable fractions are expected to continue to decline naturally through existing biological and geochemical processes. The existing beach berm will continue to provide sediment containment in this alternative. The beach berm will be inspected annually, maintenance will be completed as needed, and modification of the beach berm will be restricted by institutional controls.

**Pond 8 AOC:** Remedial alternatives evaluated in the OU-E FS for aquatic sediment in Pond 8 included the following: 1) No Action; 2) Institutional Control / Containment (containment, land use controls, sediment management, and long-term operations and management); 3) Treating sediment in place through stabilization by the addition of binders and Portland cement to restrict exposure of potential receptors to affected media by limiting potential direct contact with affected sediment or infiltration of water; 4) Construction of an upland vegetated cover to cover each pond to restrict exposure of potential receptors to affected media by limiting potential direct contact with affected sediment or infiltration of water; 5) Excavation and offsite disposal of sediment; and 6) Construction of a vegetated wetland cover to cover each pond to restrict exposure of potential receptors to affected media by limiting potential direct contact with affected sediment or infiltration of water.

Based on the analysis presented in the OU-E FS, the Institutional Control / Containment alternative is the preferred alternative for the Pond 8 AOC as it provides adequate control of potential exposure pathways for future receptors without the destruction of wetlands and associated mitigation. This alternative also allows Pond 8 to continue to receive and treat stormwater from the site and the City. Although it was associated with lower reduction of

toxicity, mobility, and volume, institutional control / containment provide adequate control of potential exposure pathways for future receptors. The benefits of a physical cover were offset by the effort and disruption required for implementation and potentially regular O&M. The benefits of excavation and disposal were offset by the effort and disruption required for implementation and the need to transport and dispose the sediment at a landfill. The cost difference between the alternatives was not justified by limited benefits of the vegetated soil cover or excavation and disposal alternatives. To address California Division of Safety of Dams (DSOD) requirements, the Mill Pond Dam will be modified to add a soil buttress at the northeastern end and a rock slope protection at the crib wall near the ocean. This alternative will require regular inspection and maintenance of both the Mill Pond Dam and the beach berm, including vegetation control on the beach berm, as well as annual inspection, maintenance, vegetation control, and periodic survey of the Mill Pond Dam.

**OU-E Groundwater AOC:** Remedial alternatives evaluated in the OU-E FS for OU-E groundwater included the following: 1) No Action; 2) Restricted use; 3) monitored natural attenuation (MNA) and institutional controls; 4) Enhanced aerobic bioremediation; and 5) Enhanced anaerobic bioremediation.

Based on the analysis presented in the OU-E FS, MNA combined with institutional controls is the recommended alternative for the OU-E Groundwater AOC. Although the MNA alternative was associated with a slightly lower reduction of toxicity, mobility, and volume, MNA provides adequate control of potential exposure pathways for future receptors. The benefits of the active remediation alternatives were offset by the short-term effectiveness and potential implementability issues, and the cost difference was not justified by significant benefits and was associated with a degree of uncertainty. The Operable Unit D and Operable Unit E Groundwater Operation & Maintenance Plan (Kennedy Jenks 2020a) has been approved by DTSC (DTSC 2020a).

## Section 1: Introduction

---

This Remedial Action Plan (RAP) was prepared by Kennedy/Jenks Consultants Inc. (Kennedy Jenks) on behalf of Georgia-Pacific LLC (Georgia-Pacific) for Operable Unit E (OU-E) at the former Georgia-Pacific Wood Products Facility (site) located at 90 West Redwood Avenue in Fort Bragg, Mendocino County, California, as shown on Figure 1-1. This RAP was prepared as required by the California Department of Toxic Substances Control (DTSC) under Site Investigation and Remediation Order Docket No. HAS-RAO 06-07-150 (Order).

A draft RAP was submitted to DTSC on 8 September 2020 (Kennedy Jenks 2020d). DTSC provided comments on 7 October 2020 (DTSC 2020d). This RAP has been revised in accordance with DTSC comments.

The 415-acre site is located west of Highway 1 along the Pacific Ocean coastline and is bounded by Noyo Bay to the south, the City of Fort Bragg (City) to the east and north, and the Pacific Ocean to the west. Union Lumber Company began sawmill operations at the site in 1885. Georgia-Pacific acquired the site in 1973. Sawmill operations at the site included lumber production and power generation by burning residual bark and wood. Georgia-Pacific ceased operations on 8 August 2002. Much of the equipment and structures associated with the sawmill operations have been removed. The City acquired and improved 82 acres of land known as Noyo Headlands Park, which extends over the northern and southern coastal bluff at the former Mill Site. Noyo Headlands Park includes 5.4 miles of trails and various improvements. An additional public coastal trail extending from the southern end of the property 0.8 mile to the northern side of the City Wastewater Treatment Plant on 5 acres was opened in 2016 (called the “Coastal Trail”). Another approximately 10 acres was donated to the City in 2017 to connect the northern and southern ends of the Coastal Trail. With the exception of the public coastal trails, the site is fenced and locked to restrict trespassers.

OU-E is one of five operable units on the site (Figure 1-2) and consists of approximately 12 acres of man-made ponds and seasonal wetland areas and 45 terrestrial acres divided into eight areas of interest (AOIs). Aquatic areas include Ponds 1 through 9 and the North Pond. Terrestrial areas include the Water Treatment and Truck Dump AOI, Sawmill #1 AOI, Compressor House and Lath Building AOI, Powerhouse and Fuel Barn AOI, and Pond 8 Fill Area AOI as well as the Riparian AOI, Interim Remedial Measure (IRM) AOI and West of IRM AOI (Figure 1-3), which were transferred from OU-C and OU-D. Predominant industrial features in OU-E were related to power production, milling of timber, water treatment, management of fly ash, and fuel storage (Figure 1-4). The ponds were constructed for operational purposes, including management of wastewater from site operations, providing a source of water for firefighting, and use as a log pond. Ponds 1 – 4, 6, 7, and the North Pond were constructed during operation of the Mill between 1952 and 1996 (see Figure 1-8). Pond 2 is present on the earliest available aerial photograph but appears to be smaller than later configurations and may have been a site feature prior to development of the surrounding area. Pond 8 was constructed during the initial development of the Mill Site around 1885 as the log pond (Figure 1-9). Based on aerial photographs, the earliest documented size of Pond 8 was approximately 13.23 acres, and minimal changes in pond size occurred until after 1966 when several fill operations occurred. Pond 8 is currently approximately 7.24 acres. Additional details about these modifications or historical Pond 8 maintenance dredging or fill are not documented in available



site historical information. Pond 8 also receives stormwater runoff from portions of the Mill Site via surface sheet flow and the City via the City's stormwater collection system. The majority of industrial features within OU-E have been removed. In locations shown on Figure 1-4, soil was placed in portions of the terrestrial area to cover foundations in the lowland following building demolition and interim cleanup activities in those areas. Currently, OU-E is vacant; there are no structures or uses in the terrestrial area and the primary use of the aquatic areas, specifically Pond 8, is to provide stormwater management for the City prior to discharge to the ocean. However, the central section of the Coastal Trail was constructed through a portion of OU-E and is separated from the Mill Site with property line fencing that is marked with warning signs. The foreseeable future use of OU-E is as continued stormwater management facilities, parkland, and recreational trail development. Some commercial land use may occur in Parcel 5, depending on the outcome of the City planning process. The status of the AOIs/areas of concern (AOCs) is presented on Figures 1-5 and 1-6.

The Final OU-E Feasibility Study (OU-E FS; Kennedy Jenks 2019), dated 12 September 2019, was approved by DTSC on 24 October 2019 (DTSC 2019). The OU-E Remedial Action Workplan (OU-E RAW) was prepared prior to finalization of the FS to expedite remediation in select AOIs/AOCs to facilitate construction of the City's Coastal Trail (Arcadis 2016). Areas evaluated in the FS due to the presence of potential risk following completion of the remedial investigation (RI), Baseline Human Health and Ecological Risk Assessment (BHHERA), and subsequent RAW implementation are herein described as "Areas of Concern" (AOCs). Areas where no unacceptable potential risk was found to be present following completion of the RI, BHHERA, and subsequent RAW implementation and were not considered in the FS because they were approved for no further action (NFA) are herein described as "Areas of Interest" (AOIs), consistent with nomenclature used in the RI and BHHERA process. Excavation and disposal were approved as the remedial action for the Lowland Terrestrial Soil AOI, the Pond 7 Aquatic Sediment AOC, the Ponds 1 through 4 (Southern Ponds) Aquatic Sediment AOC, and the Riparian Aquatic Sediment AOI. Hot spots were removed in multiple areas throughout the Lowland Terrestrial AOI, in one location in Pond 2, in one location in Pond 3, and in four locations in the Riparian AOI, and sediment was removed from Pond 7. Implementation was completed in 2017 and summarized in the Remedial Action Completion Report for Operable Units OU-C, OU-D, and OU-E (RACR; Kennedy Jenks 2018a), which was approved by DTSC on 27 June 2018 (DTSC 2018). The Lowland Terrestrial Soil AOI and the Riparian Area AOI were approved for NFA (DTSC 2018). The Southern Ponds (Ponds 1-4) Aquatic Sediment AOC, Pond 7 Aquatic Sediment AOC, North Pond and Pond 6 Aquatic Sediment AOC, the Pond 8 Aquatic Sediment AOC, and the OU-E Groundwater AOC were evaluated in the OU-E FS.

## 1.1 Regulatory Framework

This RAP has been prepared pursuant to California Health and Safety Code (HSC) Section 25356.1 and in accordance with DTSC Guidance Document No. EO-95-007-PP, Remedial Action Plan Policy (DTSC 1995). Consistent with HSC Section 25356.1, the RAP will be made available for review and comment by the public and regulatory agencies.

The California Environmental Quality Act (CEQA) document will also be circulated for public review simultaneously. In accordance with CEQA, the City of Fort Bragg, as lead agency, will prepare an Environmental Impact Report (EIR) for public review to satisfy CEQA requirements.

The final EIR will be included in Appendix B of the Final RAP. DTSC responses to public comments will be provided in the Responsiveness Summary included in Appendix C of the Final RAP.

## 1.2 Objectives

Remedial actions presented in the OU-E RAW were completed in 2017, as summarized in the RACR. Based on the analysis presented in the OU-E FS, additional remedial alternatives were recommended to address contaminants of concern (COCs) within sediment and/or groundwater for five AOCs within OU-E. This RAP summarizes the completed remedial actions and areas approved for NFA, further outlines proposed remedial alternatives recommended in the OU-E FS, and identifies the remedial actions to be performed in remaining areas.

Based on the Order and site-specific information, the objectives of this RAP are as follows:

- Summarize background information and findings from the remedial investigation (RI) pertinent to the evaluation and selection of remedial alternatives.
- Summarize the FS alternatives considered for each AOC and evaluated using the nine evaluation criteria described in Section 4.1.1.
- Summarize remedial action objectives (RAOs).
- Detail proposed remedial actions, based on the analysis presented in the FS.
- Provide a preliminary schedule for implementation of proposed remedial actions.

## 1.3 Report Organization

This RAP presents information regarding environmental conditions at the site and proposed remedial actions to address site-related risk to human health and the environment. The remainder of this RAP is organized as follows:

- Section 2 presents background information relevant to the scope of this RAP and describes subsequent investigation activities conducted since the submittal of the RI Report and FS Report for OU-E.
- Section 3 summarizes RAOs and chemical-specific cleanup levels for remedial actions in AOCs addressed in this RAP.
- Section 4 describes the alternatives evaluated, summarizes the evaluation criteria, provides the recommended alternatives, and details remedy implementation for AOCs in OU-E.
- Section 5 summarizes the reporting and schedule prior to, during, and following RAP implementation.
- Section 6 identifies references cited throughout this RAP.

- Appendix A provides a listing of the Administrative Record.
- Appendix B will provide the CEQA EIR in the Final RAP.
- Appendix C will provide the response to public comments on the draft RAP and EIR in a Responsiveness Summary in the Final RAP.
- Appendix D will provide the Statement of Reasons and the Nonbinding Preliminary Allocation of Responsibility in the Final RAP.

## Section 2: Background Information

---

This section presents the site setting, summarizes previous investigations and interim remedial measures, and provides an overview of the nature and extent of chemicals of interest (COIs). Chemicals that were identified as potential risk drivers in the BHHERA (Arcadis 2015b) are termed COC herein. The information provided is primarily based on data reported in the OU-E RI Report (Arcadis 2013a), BHHERA, Remedial Investigation, Operable Units C and D (OU-C and D RI Report; Arcadis 2011a), Feasibility Study, Operable Units C and D (Arcadis 2012a), OU-E FS (Kennedy Jenks 2019a), and Operable Unit D and Operable Unit E Groundwater Operation & Maintenance Plan (OU-D/E GW O&M Plan; Kennedy Jenks 2020a).

### 2.1 Site Setting

This section presents the site setting in terms of land use, ecology, climate, geology, hydrogeology, occurrence of groundwater, surface water hydrology, and cultural resources.

#### 2.1.1 Geology and Hydrogeology

##### 2.1.1.1 Regional

Fort Bragg is located along the northern California coastline within the Coast Range geomorphic province. The regional geology consists of complexly folded, faulted, sheared, and altered bedrock. The bedrock of the region is the Franciscan Complex of Cretaceous to Tertiary (late Eocene) age (40 to 70 million years old). The Franciscan Complex comprises a variety of rock types. In the north coast region, the Franciscan Complex is divided into two units: the Coastal Belt and the Melange. In Mendocino County, the Melange lies inland and is an older portion of the Franciscan Complex, ranging in age from the Upper Jurassic to the late Cretaceous. The Coastal Belt consists predominantly of greywacke sandstone and shale.

Besides the Coastal Belt, other geologic units present in Fort Bragg and in the vicinity include surficial deposits of beach and dune sands, alluvium, and marine sediments. As discussed below, the most important of these at the site are the marine sediments, which cut bedrock surfaces along the coast and form much of the coastal bluff material overlying bedrock. Artificial fill (reworked native soil or imported material) is also prevalent at the site.

The surficial geology of the site and environs is depicted on Figure 2-5. The site is underlain by Quaternary (less than 1.5 million years old) marine sediments deposited in thicknesses up to 30 feet on wave-cut surfaces parallel to the coast (Blackburn Consulting, Inc. 2006). These surfaces were created during the Pleistocene Epoch, when sea level fluctuations caused by glaciation created a series of terraces cut into the Franciscan bedrock by wave action (BACE Geotechnical 2004). The marine sediments comprise poorly to moderately consolidated silts, sands, and gravels, and in some locations, are overlain by a 3- to 4-foot-thick mantle of topsoil or up to a 20-foot-thick layer of artificial fill (BACE Geotechnical 2004). Both the topsoil and fill are generally relatively coarse in texture, ranging primarily from sandy silts to gravel. The marine sediments are also generally coarse, but appreciable thicknesses of finer materials are also found onsite. Beneath these Pleistocene materials are the Tertiary-Cretaceous rocks

(approximately 65 million years old) of the Coastal Belt, composed of well-consolidated sandstone, shale, and conglomerate.

### **2.1.1.2 OU-E Specific**

The shallow subsurface of the terrestrial portions of OU-E contains up to three lithologic units: artificial fill, marine sediments, and bedrock.

#### **2.1.1.2.1 Artificial Fill**

Soil borings, test pits, and potholes completed in the terrestrial portions of OU-E identified artificial fill in most areas. In general, the fill consists of reworked marine sediments with foreign materials. It can be generally characterized as coarse-textured material (silty sands to silty gravels), often containing wood chips, bark, ash, sawdust, brick, scrap metal, charcoal, and plastic. Fill thicknesses greater than 30 feet below ground surface (bgs) have been observed along the eastern edges of Ponds 6 and 8, but thicknesses on the order of 5 to 10 feet bgs are more common in the terrestrial areas and around the ponds in Parcel 7.

#### **2.1.1.2.2 Marine Sediments and Bedrock**

Marine sediments and bedrock underlie the artificial fill (where present) in OU-E. As with other portions of the site, Franciscan bedrock is present beneath the upland portions of OU-E but based on lithological information available from borings advanced at the site, its surface undulates and depths to bedrock can vary widely over short lateral distances. For example, within a 350-foot distance along the eastern edge of Pond 8, depths to bedrock vary from less than 10 feet bgs to greater than 40 feet bgs. Bedrock depths are generally shallow (approximately 10 feet bgs) near the ponds in Parcel 7, but in the formerly developed areas of Sawmill #1 and the Powerhouse, bedrock depths are generally no less than 30 feet bgs. In some locations around the margins of Pond 8, marine sediments are completely absent and artificial fill is in direct contact with bedrock.

### **2.1.1.3 OU-C and OU-D Specific (Riparian AOI, IRM AOI, and West of IRM AOI)**

Similar to OU-E, the shallow subsurface of OU-C and OU-D in areas transferred to OU-E contains up to three lithologic units: artificial fill, marine sediments, and bedrock. The artificial fill thickness has been measured up to 18 feet bgs within Parcel 5, which includes the IRM AOI and the West of IRM AOI. The Riparian AOI lies on the eastern edge of Parcel 7, where fill thicknesses are typically 10 feet bgs. Similar to OU-E, marine sediments and bedrock underlie the artificial fill in OU-C and OU-D. The bedrock surface has been observed to range between approximately 10 and 30 feet bgs.

## **2.1.2 Hydrology**

### **2.1.2.1 Regional**

The regional hydrogeologic setting of the Mendocino County coast has been presented in the Mendocino County Coastal Ground Water Study (California Department of Water Resources 1982). The site is located in the western coastal area of the county, which was divided into five subunits in the study: Westport, Fort Bragg, Albion, Elk, and Point Arena, separated by the

major rivers that discharge to the Pacific Ocean. The study included all areas where coastal terrace deposits had been mapped. The site is located within the Fort Bragg subunit, which extends from Big River to the south to Ten Mile River to the north.

Fresh groundwater is primarily obtained from shallow wells in the semi-consolidated marine terrace deposits or through municipal or privately-owned water systems. These water systems divert surface flow and springs or tap shallow alluvial aquifers. A combination of wells and surface water diversions is commonly necessary to provide adequate supply year-round.

### 2.1.2.2 Site Groundwater Occurrence and Hydraulic Properties

Based on quarterly monitoring from 2004 to 2012 and semi-annual monitoring from 2013 to 2019, groundwater generally flows radially at the site toward Fort Bragg Landing and the Pacific Ocean (Figure 2-6) under average horizontal hydraulic gradients ranging from approximately 0.016 foot per foot (ft/ft) to 0.094 ft/ft (Kennedy Jenks 2020a). Groundwater elevations tend to range from approximately 7 to 91 feet relative to the Northern American Vertical Datum of 1988 (NAVD 88). Depending on the location, seasonal fluctuations in groundwater levels of up to 12 feet have been observed. Figure 2-6 provides the groundwater contour map for groundwater wells in OU-E based on water elevations measured in February 2019.

### 2.1.2.3 Groundwater Use

Groundwater is not currently used at the site. Groundwater in OU-E is generally relatively shallow. Most areas of OU-E, particularly all of the OU-E lowland, are close to the ocean and groundwater use may promote salinity and the potential to promote saltwater intrusion. Further, groundwater use in the OU-E lowland would dewater the existing groundwater-fed wetlands and wetland destruction in these areas would not be acceptable to applicable permitting agencies. Therefore, groundwater use for municipal or industrial purposes in OU-E is not expected, particularly in the shallow zones in the current monitoring program. The City allows the use of groundwater only for non-potable landscaping irrigation. Additionally, as presented in the OU-E FS and discussed in Section 4.1.6, the recommended alternative for OU-E Groundwater includes restriction of groundwater use as defined by a Land Use Covenant (LUC).

## 2.1.3 Surface Water Hydrology

Figure 1-3 identifies the locations of 10 man-made ponds (Ponds 1 through 9 and the North Pond) ranging in size from 0.1 acre to 7.29 acres. The ponds served operational purposes, and Pond 8 also provides stormwater management for the City. Water transfer into and among the ponds was an integral part of the operational history of the site. Figure 1-7 provides a schematic illustration of surface water flow at the site. More information on use of the ponds during historical site operations was presented in the OU-E FS.

Most waters and wetland features rely on direct precipitation and surface water runoff. Some wetland seep features receive groundwater discharge as well. Waters and wetlands in this area lack a direct hydrologic surface connection to Fort Bragg Landing with the exception of Pond 6, which has a surface flow connection to Fort Bragg Landing via a corrugated high-density polyethylene (HDPE) culvert that discharges through the beach berm separating the OU-E

lowland from Fort Bragg Landing. Runoff into the OU-E lowland also occurs from impervious surfaces (i.e., asphalt and concrete) in the higher elevation areas located to the north and east.

Pond 8, also known as the Log Pond or Mill Pond, was created in the late 1800s by the damming of Maple and Alder Creeks. Pond 8 receives stormwater runoff from the Mill Site, the City, and overflow from Pond 5. It is estimated that approximately 50 to 60 percent of the stormwater runoff entering the pond comes from the City, depending on storm conditions and magnitude (Arcadis 2012b). Water from Pond 8 discharges over the dam spillway to the beach adjacent to Fort Bragg Landing.

In the past, the Southern Ponds (Ponds 1 through 4) received water from site operations. Currently, the Southern Ponds capture rainfall, stormwater runoff and some groundwater seeps. The bottom elevation of Pond 1 lies above the groundwater table, making Pond 1 seasonal and dry for a portion of the year. Ponds 2 and 4 are also seasonal, but have some groundwater input as the water table can rise above the pond bottom during the rainy season. The southeastern and northwestern portions of Pond 3 generally have groundwater infiltration year-round.

Pond 5 currently receives runoff from the Lyme Timber Office area located to the north of the Pond. Pond 9 historically received surface water pumped from Pudding Creek to supply water to hydrants for firefighting; water is no longer pumped from Pudding Creek to Pond 9.

#### 2.1.4 Biological Setting

The majority of OU-E, along with the IRM AOI and West of IRM AOI, was previously developed industrial land characterized by large areas covered with structures/foundations, asphalt, crushed rock, or a mixture of both. Weedy ruderal vegetation is occasionally observed in these areas [WRA Environmental Consultants (WRA) 2005].

Within OU-E, identified wetlands and waters include ponds and ditches used in former sawmill operations and seasonal wetlands<sup>1</sup>, and wetland seeps<sup>2</sup> (Figures 2-2, 2-3, and 2-4). Most of the ponds at the site are dominated by species typical of freshwater marshes, although a few consist of open water with less than 5 percent cover by vegetation.

Two environmentally sensitive habitat area (ESHA) delineation efforts occurred to identify “any area in which plant or animal life or their habitats are either rare or especially valuable because of their special nature or role in an ecosystem and which could be easily disturbed or degraded by human activities and developments” [California Coastal Commission (CCC) definition; CCC 2000]. In 2009, WRA delineated 20 waters, including wetlands, totaling 13.31 acres, including Ponds 1 through 9 and the North Pond (classified as industrial ponds), and three wetland seeps on the vegetated slope of the northern portion of OU-E (Wetlands B, C, and D, shown on Figure 2-3; WRA 2009).

<sup>1</sup> Seasonal wetland plant communities occur in depressions that are inundated during the rainy season for sufficient duration to support vegetation adapted to wetland conditions.

<sup>2</sup> Freshwater seep plant communities are wetlands containing perennial and annual herbs, including sedges and grasses, which occur in areas that receive perennial or semi-perennial hydrological input as a result of subsurface flow of water.

In 2010, Arcadis identified three wetland seeps (the eastern portion of Wetland E-1, Wetland E-3, and Wetland E-8) and four seasonal wetlands in OU-E (the western portion of Wetland E-1, Wetland E-2, Wetland Complex E-5 and E-6, and Wetland E-7; Figure 2-3). One additional wetland classified as an industrial pond (Wetland E-4) was identified in a concrete-lined pit that was a remnant of a demolished building. Additional discussion of these areas is included in the *Environmentally Sensitive Habitat Areas Delineation Report* (Arcadis 2011b).

In 2017, Wetland E-6 was expanded by the wetland establishment area as part of mitigation for remedial actions completed in 2017. The expansion of the existing wetland was presented in the Wetland Establishment Area Annual Report and As-Built Conditions for Georgia-Pacific Fort Bragg Mill Site (WEA Report; Kennedy Jenks 2018b). Mitigation monitoring for Year 1 (ESA 2018) and Year 2 (ESA 2020) has been completed.

Additional biological assessment is discussed in Section 2.4.2.

### 2.1.5 Cultural Resources

TRC (2003, Undated #1, and Undated #2) conducted archival research and archeological surveys of the site and found that portions of the site are considered likely to contain intact prehistoric deposits, as well as historic sites. Areas that are likely to contain historic deposits are important in understanding the early settlement and development of the local community, as well as the lumber operations onsite.

Within OU-E, TRC identified moderate to high potential for prehistoric resources in the lowland terrestrial area. The area nearest Fort Bragg Landing was identified as having a high potential for prehistoric cultural resources. Although subsequent industrial activities may have destroyed prehistoric deposits near Fort Bragg Landing, the road and sea wall may have preserved possibly significant prehistoric cultural resources. OU-E was also identified as having high potential for historic resources. Historic buildings and infrastructure associated with past milling operations are found throughout the lowland terrestrial area (TRC 2003).

No prehistoric sites were identified in the IRM AOI and the West of IRM AOI. TRC identified moderate potential for subsurface historic resources within the IRM AOI and the West of IRM AOI.

Within OU-D, the area identified by TRC that is considered to have a high potential to contain prehistoric cultural remains is the wooded area (Riparian AOI) on the eastern side of the site adjacent to the nursery. This AOI has been largely untouched by the industrial development that occurred on the other portions of the site. Most of the Riparian AOI was categorized as having moderate potential for historic resources, with the exception of a small area on the southwestern boundary of the Riparian AOI. This area may contain debris that may relate to earlier phases of lumber operations (TRC 2003).

## 2.2 General Site History of OU-E

According to historical records, Union Lumber Company (ULC) began sawmill operations at the site in 1885. Georgia-Pacific acquired the site in 1973 and ceased lumber operations on 8 August 2002. Most of the equipment and structures associated with the lumber production



have since been removed. Industrial operations at the site included lumber production and power generation by burning residual bark and wood.

As defined in the Order, OU-E (ponds/park) is within the Upland Zone (OU1). The Upland Zone is the elevated land beginning from the inland edge of the Coastal Trail and Parkland Zone (OU-A) and moving inland. OU-A forms the western boundary of OU-C and OU-D; OU-A received closure from the DTSC in December 2009 and was transferred to the City in January 2010. OU-E includes portions of the following Assessor's Parcel Numbers (APN): 008-020-15, 008-161-08, 008-170-07, 008-170-06, 018-010-67, 018-020-01, and 018-430-21. The IRM and West of IRM AOIs were added from OU-C and the Riparian Area AOI was added from OU-D. The total acreage for OU-E is approximately 67 acres and includes 10 man-made ponds (Ponds 1 through 9 and the North Pond) that range in size from 0.1 acre to 7.29 acres.

Based on a review of historical information, the COIs potentially associated with the former industrial activities at OU-E are primarily metals, polycyclic aromatic hydrocarbons (PAHs), total petroleum hydrocarbons (TPH) and other fuel-related hydrocarbons, polychlorinated dibenzo-p-dioxin/polychlorinated dibenzofuran (dioxins/furans), polychlorinated biphenyls (PCBs), and volatile organic compounds (VOCs).

Much of the terrestrial portion of OU-E is situated in an area of lower elevation north of Pond 8, just east of the offshore area known as Soldier Bay, also known as Fort Bragg Landing. This area is approximately 20 to 40 feet lower in elevation than the remainder of the site. Most industrial features within OU-E have been removed, with the exception of a few smaller features shown on Figure 1-4. With the exception of these remaining industrial features, OU-E is generally vacant. There are no active structures or uses in the terrestrial area and the primary use of the aquatic areas, specifically Pond 8, is to provide stormwater management prior to discharge to the ocean. While foundations of former buildings remain in certain portions of this area, there has been extensive investigation of these areas. Public coastal trails extending both north and south of Fort Bragg Landing were opened in 2014 and 2016, respectively. The northern and southern portions of the public coastal trail were connected through OU-E in 2018. The trail corridor was fenced by the City to exclude trespassing onto the remainder of the Mill Site. The foreseeable future use of OU-E is as continued stormwater management facilities, open space, and recreational trail development. The City's Land Use Plan prepared in 2017 during the Mill Site rezoning process<sup>3</sup> is presented on Figure 2-1. The site is fenced and locked to restrict trespassers.

ESHAs<sup>4</sup> comprise approximately one-fifth of the OU-E lowland and approximately one-third of the remaining area.

<sup>3</sup> <https://city.fortbragg.com/DocumentCenter/View/6973/MSSP-Land-USE-PLAN-1C-1-2018?bidId=>. Accessed 7 October 2020.

<sup>4</sup> ESHAs are referred to as "environmentally sensitive habitat area[s]" in Section 30107.5 of the California Coastal Act and are defined as "any area in which plant or animal life or their habitats are either rare or especially valuable because of their special nature or role in an ecosystem and which could be easily disturbed or degraded by human activities and developments". ESHAs in OU-E include wetland and open water habitats. Regulatory protection of ESHAs in the California Coastal Zone ultimately falls under the jurisdiction of the California Coastal Commission (CCC). The City administers CCC Coastal Act jurisdiction for the site under their Local Coastal Program.

## 2.2.1 OU-E Areas of Interest

OU-E was divided into 13 AOIs based on historical use and data derived from previous investigations (Figure 1-3):

1. Water Treatment and Truck Dump AOI
2. Sawmill #1 AOI
3. Compressor House and Lath Building AOI
4. Powerhouse and Fuel Barn AOI
5. Pond 8 Fill Area AOI
6. Pond 8 AOI
7. Pond 6 and North Pond AOI
8. Pond 7 AOI
9. Southern Ponds AOI
10. Ponds 5 and 9 AOI
11. West IRM AOI
12. IRM AOI
13. Riparian AOI.

Four of these AOIs (Water Treatment and Truck Dump AOI, Sawmill #1 AOI, Compressor House and Lath Building AOI, Powerhouse and Fuel Barn AOI) are collectively discussed as the OU-E Lowland Terrestrial Soil AOI and two of these AOIs (West IRM AOI and IRM AOI) are collectively discussed as the OU-E Groundwater AOC. The remaining seven AOIs are assessed individually. One AOI received an NFA determination in the RI Report, one AOI received an NFA determination in the BHHERA, and five AOIs received NFA determinations in the RACR. Five AOCs were evaluated in the OU-E FS; Remedial Actions for the five AOCs are discussed in this RAP. Table 2-1 and Figures 1-5 and 1-6 summarize the status of all AOIs/AOCs in OU-E.

### 2.2.1.1 AOIs with No Further Action Determination during Remedial Investigation

In the RI Report, an analysis of the nature and extent of COCs in AOIs resulted in one recommendation for NFA (Pond 8 Fill Area AOI). DTSC approved the Pond 8 Fill Area AOI for NFA (DTSC 2013b).

### 2.2.1.2 AOIs Recommended for NFA

The OU-E RI found that Ponds 5 and 9 have no known industrial use, and historical and RI sediment results indicate concentrations of TPHg, TPHmo, and PCBs in sediment are below OU-E RI primary screening levels (PSLs). Acetone was detected above PSLs in pond sediment samples. PAHs and dioxins/furans were detected above PSLs in one sample, collected from the surface in Pond 5. Six metals were detected above PSLs, with the majority of exceedances collected from Pond 5. None of the metal concentrations exceeds the human health PSL and most of the metal concentrations (with the exception of copper) were within the same order of magnitude as the ecological PSL or background concentration. Source classification evaluation indicates that dioxin/furan concentrations in Pond 5 and Pond 9 are consistent with ambient/mixture sources. The OU-E RI identified Ponds 5 and 9 as needing further evaluation in the OU-E BHHERA.

Sediment in Pond 5 and Pond 9 was evaluated in the BHHERA risk assessment in accordance with the recommendations in the OU-E RI. Based on the evaluation, the occasional adult recreator hazard index (HIs) and excess lifetime cancer risks (ELCRs) for Pond 5 and Pond 9 considering a 50 day per year exposure frequency are below 1 and  $1 \times 10^{-6}$  respectively. As presented in the OU-E FS (Section 2.2.6.2), Pond 5 and Pond 9 were not evaluated in the OU-E FS because the ELCR for Pond 5 and Pond 9 was below the risk management threshold of  $1 \times 10^{-6}$ . Pond 5 AOI and Pond 9 AOI are appropriate to be approved for no further action.

### 2.2.1.3 AOIs Approved for NFA in the RACR

As presented in the RACR (Kennedy Jenks 2018a), remediation of the hot spots identified in the BHHERA (Arcadis 2015) and recommended for excavation and disposal in the OU-E RAW (Arcadis 2016a) was completed in 2017. Excavation activities were completed in OU-E within the Lowland Terrestrial AOC, Pond 7 AOC, Southern Ponds (Ponds 2 and 3) AOC, and the Riparian AOI. After completion of excavation activities, residual COC concentrations at the Riparian Area AOI are below the residential screening criteria on a point-by-point basis, and therefore, NFA was recommended for the Riparian Area AOI in the RACR. EPCs for the remaining OU-E AOCs (Southern Ponds AOC, Pond 7 AOC, and Lowland Terrestrial AOC) were recalculated and compared to residential screening criteria. The Lowland Terrestrial AOC EPCs meet residential screening criteria, and therefore, the Lowland Terrestrial AOC was also recommended for NFA for soil in the RACR. The OU-E Lowland Terrestrial Soil AOC and Riparian AOI were approved for NFA by DTSC (DTSC 2018).

### 2.2.1.4 AOCs Evaluated in the Feasibility Study

The OU-E FS evaluated remedial alternatives for the following five AOCs. This list includes the affected media and COCs identified in the OU-E FS for each AOC.

1. Southern Ponds (Ponds 1-4) AOC
  - a. Aquatic sediment: dioxins, arsenic
2. Pond 7 AOC
  - a. Aquatic sediment: dioxins, arsenic, barium

3. North Pond and Pond 6 AOC
  - a. Aquatic sediment: dioxins, arsenic
4. Pond 8 AOC
  - a. Aquatic sediment: dioxins, arsenic
5. OU-E Groundwater AOC
  - a. IRM and West of IRM AOIs
    - i. Groundwater: TPHd, TPHg
  - b. OU-E Lowlands AOI
    - i. Groundwater: barium.

Background information for the AOCs evaluated in the FS is presented in the following sections.

#### **2.2.1.5 Southern Ponds (Ponds 1-4)**

Ponds 1 through 4 (a total of 2.8 acres), collectively known as the Southern Ponds, were a series of treatment ponds related to the operation of the former Powerhouse (Figure 1-7). Based on aerial photographs, Ponds 1 – 3 were constructed between 1973 and 1996. Ponds 1 through 4 were settling ponds that treated water received from Pond 7 (see Section 2.2.1.6). Pond 4 was created in 1996 to receive water from Pond 7 and was dredged once or twice annually from 1996 to 2002. The dredged material was placed in the former ash pile area located east of the Southern Ponds and removed in 2006. The Southern Ponds discharge to the southwestern end of Pond 8 through a culvert system. Exposure point concentrations (EPCs) for the Southern Ponds AOC are presented in Table 2-2.

#### **2.2.1.6 Pond 7**

Pond 7 (0.13 acre) received effluent from the wet scrubbers operating in the former Powerhouse power plant (Figure 1-7). From approximately the mid-1970s up until 1996, fly ash emissions from the boilers were controlled by multi-cyclone collectors, followed by wet scrubbers. Scrubber water from the boilers contained fly ash and was piped to two dewatering slabs where, after drying the residual, fly ash was placed in a dump hopper for removal and placement at an offsite location. Water on the dewatering slabs that did not evaporate was conveyed to Pond 7, and then pumped to Ponds 1 through 4 for further treatment. Pond 7 also received water from the dewatering slabs and wash water from the Powerhouse, as well as groundwater and surface water runoff from the Powerhouse area. EPCs for the combined dataset of Pond 6, Pond 7, and North Pond are presented in Table 2-2.

#### **2.2.1.7 North Pond and Pond 6**

Pond 6 (0.17 acre) collects stormwater runoff during winter storm events and also receives discharge from the North Pond and drainage water from Parcel 2. When the plant was

operational, water from Pond 6 (when full) would be pumped to Pond 7 and subsequently to Ponds 1 through 4 when full. There is also an overflow culvert in Pond 6 that allows discharge of stormwater to Fort Bragg Landing (Figure 1-7).

The North Pond (0.06 acre) was formerly used as a settling basin for water used during the operation of the hydraulic debarker. Water from surface runoff from the surrounding uplands to the north currently enters the North Pond via a culvert on its eastern side and discharges to Pond 6 via a culvert (Figure 1-7). EPCs for the combined dataset of Pond 6, Pond 7, and North Pond are presented in Table 2-2.

### **2.2.1.8 Pond 8**

Pond 8 (7.3 acres), also known as the Log Pond, was created in the late 1800s by the damming of Alder and Maple Creeks (Figure 1-7). The size of Pond 8 has changed over time. Based on aerial photographs, the earliest documented size of Pond 8 was approximately 13.23 acres, and minimal changes in pond size occurred until after 1966 when several fill operations occurred. Pond 8 is currently approximately 7.3 acres. Additional details about these modifications or historical Pond 8 maintenance dredging or fill are not documented in available site historical information. Pond 8 receives stormwater runoff as well as overflow from Pond 5. Water from Pond 8 discharges over the dam spillway to the beach adjacent to Fort Bragg Landing. The total contributing watershed to Pond 8 is approximately 417 acres, consisting of 190 acres (including Pond 8 itself) within the Mill Site property and 227 acres outside the Mill Site property (related to stormwater management for the City). Total direct rainfall to the surface of the pond is less than 2 percent of the total inflow to the pond. EPCs for the Pond 8 AOC are presented in Table 2-2.

### **2.2.1.9 OU-E Groundwater**

#### **2.2.1.9.1 IRM AOI**

The IRM AOI is located directly south of Pond 5 (Figure 1-3). The AOI was dominated by the Former Parcel 5 Mobile Equipment Shop (MES) and adjacent buildings, such as the Former Tire Shop, the Former Washdown Building, and the Former Fuel Storage and Dispenser Building. A truck wash pit was formerly located southwest of the Former Fuel Storage and Dispenser Building.

The Former Parcel 5 MES historically housed tanks containing petroleum solvent, acetylene, and oxygen. In addition, the Former Parcel 5 MES contained an old diesel dispenser, a former paint storage room at the northwestern corner of the building interior, a former oil change waste pit in the northern portion of the building interior, and a room that formerly housed an air compressor north of the fuel dispenser at the building exterior. Within the building were two sheds that were used for chemical storage, including lube oil, waste oil, used oil filters, transmission fluid, hydraulic fluid, grease, and antifreeze. At the time of AME's (2005a) additional investigation work, the western shed contained 1,100 gallons of tractor hydraulic fluid and 330 gallons of lube oil in the form of six 55-gallon drums. Prior to this, the shed contained four 27-gallon aboveground storage tanks (ASTs) (three containing hydraulic fluid and one containing transmission fluid); five plastic and metal 55-gallon drums containing gear lube oil, used oil, waste-paint-related material, used oil filters, and lube oil; and two open 55-gallon drums, cut in half, that contained used oil, oil-stained cardboard, oil-stained spill pads, and booms. A concrete-lined pit covered by a perforated steel plate was also located in the shed.

Water and sludge collected in the pit and were periodically removed. An AST was also formerly located just outside the southwestern corner of the building. The Former Parcel 5 MES was demolished in summer 2007.

The Former Tire Shop was a 40-foot by 50-foot building located west of the southern end of the Former Parcel 5 MES. It was constructed between the late 1980s and early 1990s. Maps and photographic evidence from 1963 to 1982 show a different building in this location, but there are no records pertaining to its use (AME 2005). The Former Tire Shop was demolished in summer 2007.

The Former Washdown Building was located immediately southeast of the Former Parcel 5 MES and contained three sumps. One was located in the northwestern corner of the building, one near the center of the building, and another in the southern portion of the building next to the fuel island. A recycled AST was also located in this area. North of the building was an area with surface staining and a drainage area. The Former Washdown Building was demolished in summer 2007.

The Former Fuel Storage and Dispenser Building was the southernmost building in Parcel 5. It housed four ASTs that were used to store lube oil, unleaded gas, diesel, and waste oil. Piping from the northwestern corner of the Former Fuel Storage and Dispenser Building ran underground from the waste oil and lube oil ASTs northward along the western side and to the northwestern corner of the Former Parcel 5 MES. An additional covered trench for compressed air piping ran from the Former Fuel Storage and Dispenser Building to the Former Washdown Building. The piping entered the Former Parcel 5 MES and was formerly connected to an interior oil fuel dispenser adjacent to the former paint storage room. The Former Fuel Storage and Dispenser Building was demolished in summer 2007.

Southwest of the Former Fuel Storage and Dispenser Building was the location of the Former Truck Wash Pit. The 1981 plant drain map (Georgia-Pacific 1981) shows an oil trap, sump, and wash rack in this area. The pit was open but is now backfilled. The Phase I Environmental Site Assessment (ESA; TRC 2004a) identified an oil trap in this area and there may have been a separator associated with the pit.

An interim action involving the excavation of impacted soils from this area (Arcadis 2008b) was completed in 2009. Impacted soils were removed, and clean, treated soils were backfilled into this area (Arcadis 2010a). The interim action is discussed in further detail in Section 2.5.1.

### **2.2.1.9.2 West of IRM AOI**

The West of IRM AOI is bounded by the IRM delineation on the east, the OU-D delineation on the south, and the OU-E delineation on the west (Figure 1-3). It extends no further north than the IRM. An interim action (Arcadis 2008b) completed in 2009 extended into this AOI. Impacted soils were removed, and clean, treated soils were backfilled into this area (Arcadis 2010a). The interim action is discussed in further detail in Section 2.5.1.

## 2.3 Conceptual Site Model

The conceptual site model (CSM) describes the relationship between chemical sources, migration pathways, exposure routes, and possible exposure pathways for human and ecological receptors potentially present in AOIs within OU-E selected for remedial activity evaluation in the RI Report.

### 2.3.1 Sources of Chemicals

During normal operations in OU-E, several substances that could be considered hazardous if released into the environment were used. These substances included, but may have not been limited to, petroleum hydrocarbons, asbestos, PCBs, lead [including from lead-based paint (LBP)] and other metals, various VOCs and semi-volatile organic compounds (SVOCs), cyanide, and dioxins/furans (associated with fly ash). A few areas contained transformers and had drum and other hazardous materials storage. Water treatment chemicals were used, as well as small quantities of solvents and hydraulic fluids.

### 2.3.2 Chemicals of Interest

COIs are chemicals that could potentially be associated with the products, materials, and wastes used or generated at the facilities discussed above in Section 2.3.1. The primary chemical constituent/product used across the site was petroleum (BBL 2006). Onsite tanks and drums stored diesel, motor oil, fuel oil, lube oil, hydraulic oil, and dielectric oil (a petroleum-based electrical insulating oil). Jet fuel and gasoline were also used at specific locations. Other chemicals used onsite included antifreeze and transmission fluids for vehicle servicing, water treatment chemicals, small quantities of acids/bases, solvents, paint, and paint thinners. Some acetylene and oxygen tanks were located onsite.

Mill site-related sources of dioxins/furans in soil and sediment include fly ash derived from burning redwood bark in the hog fuel boiler, which was used to generate electricity for facility operations. During a 1- to 2-year period of time just prior to cessation of mill operations, “municipal wood” was also burned in the hog fuel boiler because the mill was scaling back operations and not enough redwood bark was available to provide power to the grid. Municipal wood was obtained from landfills and includes wood derived from various activities, such as construction and demolition.

### 2.3.3 Fate and Transport

In OU-E, the primary potential migration pathways are direct releases to surface and subsurface soil, infiltration of rainwater and percolation of groundwater, surface water runoff, and dust generation. Releases from subsurface features such as underground storage tanks (USTs) or sumps are directly to the subsurface soil. Impacts in the subsurface soil can affect shallow groundwater beneath the site. Dissolved constituents can be transported downgradient as a result of advective groundwater flow. Pond 8 also receives stormwater runoff from portions of the Mill Site via surface sheet flow and the City via the City’s stormwater collection system.

## 2.4 Previous Remedial Investigations

This section describes previous environmental investigations, biological assessment, IRMs, remedial investigations, and risk assessments. The dataset includes analytical results from the previous investigations described in the subsections below. The data discussed herein have been previously presented in the RI Report and the FS, as well as other documents.

Investigation data collected prior to January 1998 were excluded as they have not been formally validated and have limited quality assurance/quality control information. Additionally, their age is a concern for characterizing current site conditions. Data from the investigations presented below were found usable, with the exception that additional data validation was required and completed for the data collected from January 1998 to March 2005, which did result in the qualification of a few analytical data points (Arcadis 2010b). These data were used in the OU-E work plans (Arcadis BBL 2007b, 2007c; Arcadis 2010b, 2013b, 2014), OU-E RI Report, and BHHERA in order to adequately characterize the nature and extent of COCs in OU-E and associated AOIs (IRM, West of IRM, and Riparian AOIs formerly associated with OU-C and OU-D).

### 2.4.1 Environmental Investigations

This section summarizes environmental investigations conducted at the site relevant to OU-E, including LBP investigations, Phase I and Phase II environmental assessments, 2004 and 2005 additional site assessments, and groundwater monitoring.

#### 2.4.1.1 Lead-Based Paint Investigation

In January 1998, TRC conducted a preliminary investigation of surface and shallow subsurface soil to evaluate paint on select buildings for elevated lead levels and to evaluate whether chemicals associated with site operations were present in subsurface soil in the areas scheduled for demolition in Parcels 3, 4, and 5 (TRC 1998).

#### 2.4.1.2 Phase I Environmental Site Assessment

TRC performed a Phase I ESA of the site between 2002 and 2004 (TRC 2004a). The Phase I ESA included visual inspections of each parcel; a site history survey, including historical Sanborn® maps, historical U.S. Geological Survey maps, and aerial photograph review; personal, telephone, and written communication with local and county regulatory agencies; interviews with current and past Georgia-Pacific employees with historical operational knowledge of the site; and a computer database search of sites with known environmental concerns within a 1-mile radius of the site.

As part of the Phase I ESA, Hygienetics Environmental Services, Inc. (Hygienetics) conducted an additional asbestos and LBP investigation in late 2002. Samples from the upland portion of OU-E were found to contain LBP in the Water Treatment Plant Building, the Chipper Building, Sawmill #1 Building, Compressor House 1, and the Powerhouse Building at concentrations up to 17,000 parts per million (ppm) lead (Hygienetics 2003).



### **2.4.1.3 Phase II Environmental Site Assessment**

TRC conducted a Phase II ESA to characterize site soils and groundwater in the AOIs identified in the Phase I ESA, and to refine the understanding of the nature and extent of affected media. Preliminary Phase II activities were conducted in March and April 2003. Supplemental Phase II activities were conducted in December 2003 and January 2004. Activities included the installation of seven monitoring wells within OU-E. The results were presented in the Phase II ESA report (TRC 2004b).

### **2.4.1.4 2004 Additional Site Assessment**

TRC conducted additional assessment activities pursuant to recommendations for follow-up assessment presented in TRC's Phase I and Phase II ESAs. The additional site investigation included the completion of pothole investigations, geophysical investigation, and soil borings for the purpose of collecting additional soil samples, and to investigate surface anomalies and potential waste deposit areas. The results of the additional site assessment were presented in the *Additional Site Assessment Report* (TRC 2004c).

### **2.4.1.5 2005 Additional Site Assessment**

In 2005 and 2006, AME conducted additional site assessment work, including additional soil and groundwater sampling, geophysical surveys, and the installation of additional groundwater monitoring wells. Activities were conducted in general accordance with the *Work Plan for Additional Site Assessment* (AME 2005). Analytical data were reported in the *Dioxin Sampling and Analysis Report* (AME 2006a) and the *Data Transmittal Report* (AME 2006b).

### **2.4.1.6 Pond Sediment Investigations**

#### **2.4.1.6.1 2008 Pond Sediment Investigations**

Arcadis conducted pond sediment sampling activities in March 2008, as described in the *Data Summary Report, Operable Unit E Pond Sediment* (Arcadis 2009). These activities were performed in general accordance with the *Preliminary Site Investigation Work Plan Operable Unit E – Onsite Ponds* (Arcadis BBL 2007b). Sediment samples were collected from 26 locations in Ponds 1 through 9 and the North Pond. Sediment samples were collected from the intervals of 0 to 0.5 foot below sediment surface (bss) and 0.5 to 1.5 feet bss and analyzed for COIs for which a data gap had been identified: metals, TPH as diesel (TPHd), TPH as motor oil (TPHmo), PAHs, PCBs, and dioxins and furans. In some locations, samples were also collected at depths up to 9.5 feet bss. Sample locations were selected to characterize areas not previously addressed during historical investigations and/or to fill data gaps related to the spatial and vertical distribution of specific COIs. Pond sediment sampling locations are shown on Figures 2-7 through 2-9.

#### **2.4.1.6.2 2009 Mill Pond (Pond 8) Additional Sediment Investigation**

An additional sediment sampling event was conducted in June 2009 to understand the magnitude and spatial extent of the COIs in Pond 8, to provide samples for sediment bioassay and bioaccumulation studies, and to provide paired data for estimation of site-specific

bioaccumulation factors. Sample methods and results are described in full in the *Data Summary Report – Additional Investigation Pond 8 Sediment* (Arcadis 2011c).

Because surface sediment (0 to 0.5 foot bss) was identified as the primary exposure media for Pond 8 (Arcadis BBL 2007b, Arcadis 2009), the investigation focused on surface sediment only. For this investigation, nine sediment samples were collected from Pond 8 and one sample was collected from Pond 9 to provide a basis for comparison for the Pond 8 sediment results, as Pond 9 has no known associated sources of site-related COCs. Samples were analyzed for metals, TPHd, TPHmo, and dioxins and furans, as well as bioassay and bioaccumulation testing (Arcadis 2011c). Pond sediment sampling locations are shown on Figures 2-7 through 2-9.

#### **2.4.1.6.3 2012 Mill Pond (Pond 8) Geotechnical and Chemical Investigation**

In February and March 2012, Arcadis conducted a sediment volume survey, and geotechnical and chemical investigation of Pond 8 sediments to further evaluate cleanup and restoration options. To further characterize sediment volume, the surface area of the pond was manually probed at recorded coordinates, and later integrated over the surface area of the pond to estimate a total of 106,000 cubic yards (cy) of sediment in the pond (Arcadis 2012b). Sediment samples were collected and analyzed for metals and dioxins and furans. Pond sediment sampling locations are shown on Figure 2-7.

Samples were also collected for geotechnical characterization. Results indicated that Pond 8 sediment is generally classified as silty sand with an organic content between 20 and 50 percent and a hydraulic conductivity ranging from  $1 \times 10^{-7}$  to  $4 \times 10^{-7}$  centimeters per second, which is lower than what is typically observed for silty sand. Additionally, the total porosity is higher than what is typically observed for silty sands, suggesting that the sediment also has many clayey characteristics (Arcadis 2012b).

The distribution of sediment thickness across Pond 8 and a cross-section of Pond 8, including both water and sediment depth and COC concentrations, is presented on Figure 2-10 through Figure 2-16. A statistical summary of the chemicals detected in Pond 8 was presented in the OU-E RI and OU-E FS. The maximum concentration of dioxin toxic equivalent (TEQ) in Pond 8 is 247 picograms per gram (pg/g) and the EPC in the 0 – 2 feet bss range is 110 pg/g. The EPC is the concentration of a constituent of potential concern (COPC) in an environmental medium to which a potential receptor might be exposed. For dioxin TEQ, a conservatively based 95% upper confidence limit (UCL) on the arithmetic mean concentration was estimated using U.S. Environmental Protection Agency’s (EPA’s) ProUCL 4.1 software to represent the EPC, as described in the BHHERA. The EPC is then compared to the applicable remedial goal or used to calculate risk estimates.

#### **2.4.1.6.4 2013 Baseline Human Health and Ecological Risk Assessment Porewater Investigation**

Additional sampling activities completed in 2013 followed methods presented in the OU-E BHHERA Work Plan (ARCADIS 2013b). The purpose of the OU-E BHHERA sampling activities was to evaluate the bioaccessible fraction of arsenic in OU-E sediment for potential human health receptors and to measure partitioning of metals and PAHs in OU-E and Riparian AOI sediment to porewater. Data collection activities included the collection of surface sediment samples for analysis for arsenic speciation and total arsenic, alkylated PAHs (bulk sediment and

porewater), total organic carbon (TOC), black carbon, and pH and the collection of porewater samples for analysis for metals, major cations and anions, and alkalinity.

Sediment data were used, along with historical site data sets, in the evaluation of human health and ecological risk in the human health risk assessment (HHRA). Porewater data were used in the ecological risk assessment (ERA) to assess potential risk to benthic invertebrates exposed to metals partitioning from sediment to porewater. Results of these investigations are presented in the BHHERA (ARCADIS 2015b) and indicate that the mobility of COPCs from the highly organic sediments to porewater is limited. ERA results for ponds evaluated individually indicate potential risk is not likely and the BHHERA ultimately concluded that unacceptable risks are not expected for populations of plants, benthic organisms, amphibians, birds, or mammals exposed to COPCs in sediment.

#### **2.4.1.6.5 Pond 6, North Pond, Pond 8 Sediment Sampling**

Additional sediment sampling activities were completed in 2019 in Pond 6, North Pond, and Pond 8 per DTSC request. The results were summarized in the Pond 6, North Pond, and Pond 8 Sediment Sampling Report (Kennedy Jenks 2020b), which was approved by DTSC on 26 May 2020 (DTSC 2020b). Data collected was consistent with or lower than past results. EPCs were calculated for dioxin TEQ and arsenic for the western portion of Pond 8, the eastern portion of Pond 8, Pond 8, and a combined Pond 6, Pond 7, and North Pond dataset.

#### **Pond 6, Pond 7, and North Pond**

An exposure point concentration (EPC) had not been calculated for a combined Pond 6, Pond 7, and North Pond dataset prior to the Pond 6, North Pond, and Pond 8 Sediment Sampling Report. The arsenic EPC is 25 mg/kg and is within the range of concentrations used to calculate the background value (0.6 mg/kg to 31 mg/kg; Arcadis BBL 2007d). The dioxin TEQ EPC is 109 pg/g.

#### **Pond 8**

Arsenic EPCs for Pond 8 west (12 mg/kg), Pond 8 east (9.1 mg/kg), and Pond 8 (9.7 mg/kg) are approximately equal to the draft remedial goal presented in Table 3-2 (10 mg/kg). The dioxin TEQ EPC is lower in the west portion of Pond 8, near the ocean (58 pg/g), and higher in the east portion of Pond 8, near the storm drain outfalls into the pond (142 pg/g). With the addition of new and deeper data representative of all Pond 8 sediment, the dioxin TEQ EPC for the whole pond presented in the Pond 6, North Pond, and Pond 8 Sediment Sampling Report (107 pg/g) is less than the previously calculated value presented in the BHHERA (Arcadis 2015).

The Pond 6, North Pond, and Pond 8 Sediment Sampling Report concluded that site sediment present low risk to the offshore environment and that the additional data continued to support the remedial alternative recommended in the OU-E FS.

#### **2.4.1.7 Groundwater Monitoring**

Quarterly groundwater monitoring at the site was initiated by TRC in 2004. The monitoring network has varied over the years and is currently consistent with Comprehensive Monitoring

Program (CPM) Update Number 6 (CMP Update No. 6; Arcadis 2013c) as approved by DTSC in November 2013 (DTSC 2013a). In October 2017, DTSC approved 38 wells for destruction, including three wells in the CMP Update No. 6 monitoring network (MW-3.12, MW-5.17, and MW-5.19; DTSC 2017). MW-3.12 was subsequently replaced. Correcting for the wells destroyed in 2017, CMP Update No. 6 includes the gauging of 16 groundwater monitoring wells (five of which are located in OU-E) and sampling of 15 groundwater monitoring wells (four of which are located in OU-E). In June 2020, DTSC approved an additional 20 wells for destruction, including three injection wells (Kennedy Jenks 2020c; DTSC 2020c). The comprehensive groundwater monitoring dataset for the site, including all data collected through the first quarter of 2019 from active groundwater monitoring wells, is presented in the *First Semi-Annual 2019 Groundwater Monitoring Report* (Kennedy Jenks 2019b).

#### 2.4.2 Biological Assessment

In 2005, WRA conducted a biological assessment at the site to identify biological resources at the site. A total of 54 special status species of wildlife were recorded in the site vicinity, but only three special status species (the double-crested cormorant, the California brown pelican, and the osprey) have a potential for occurrence in the site vicinity. Although these species may be observed and/or occur at times onsite, these species do not nest onsite, and are not expected to obtain a significant portion of their diet from the site. A total of 47 special status plant species were identified in the site vicinity, 18 of which have a moderate potential to occur at the site. Three sensitive plant species were found onsite during the botanical surveys: Blasdale's bent grass, Mendocino Coast Indian paintbrush, and short-leaved evax; however, none of these special status plant species are likely to occur within OU-E and monthly surveys conducted in OU-E from February to May 2010 did not identify any special status plant species (WRA 2005, updated 2007).

ESHA delineation activities were conducted by WRA in 2009 and Arcadis in 2010 to identify potential ESHAs [including potential federal and state jurisdictional waters, including wetlands (waters/wetlands)] located onsite. WRA (2009) delineated 20 waters/wetlands totaling 13.31 acres in OU-C, OU-D, and OU-E. Of these delineated areas, 8.89 acres were classified as U.S. Army Corps of Engineers (USACE) jurisdictional waters/wetlands. Approximately 308 acres of the 317 acres that Georgia-Pacific owns were considered non-jurisdictional for USACE purposes. In 2010, Arcadis identified and delineated the following additional features as potential ESHAs: 17 waters/wetlands totaling approximately 3.64 acres, approximately 2.21 acres of riparian area, and approximately 375 linear feet of bedrock groundwater seep complexes. Arcadis also delineated coastal waters associated with Fort Bragg Landing. In total, there are 48 potential ESHA areas totaling approximately 19.16 acres of the approximately 317 acres comprising OU-C, OU-D, and OU-E (Arcadis 2011a). Delineated ESHAs within OU-E are shown on Figures 2-2, 2-3, and 2-4.

In 2010, Arcadis conducted a functional assessment of the delineated potential waters/wetlands to evaluate their ecological function. Arcadis followed guidance provided in *California Rapid Assessment Method (CRAM) for Wetlands* (Collins et al. 2008). Overall CRAM scores indicate that waters/wetlands evaluated on the site possess between 33 and 58 percent of the total functional capacity that a reference wetland system could attain. These CRAM scores indicate the generally degraded character of the site waters/wetlands. Ponds on the site scored lowest in the CRAM evaluation (i.e., between 32 and 45 percent of total functional capacity). Seasonal

and seep wetlands that have developed in the OU-E lowland since demolition of the building foundations in this area scored the highest in the CRAM evaluation (i.e., 58 percent of total functional capacity). The complete results of the CRAM evaluation are presented in the *Mill Pond Complex Restoration Draft Conceptual Design* (Arcadis 2011d).

### 2.4.3 Remedial Investigations

In June 2010, additional sampling was conducted at OU-E in accordance with the *Site Investigation Work Plan, Operable Unit E – Upland* (Arcadis 2010b) in preparation of the OU-E RI Report. In October 2010, Arcadis evaluated the existing historical site data and the June 2010 sampling data and identified data gaps that required step-out sampling to fully delineate chemical impact (Arcadis 2010c). Additional step-out sampling was conducted in November and December 2010 (Arcadis 2011e). Comprehensive analytical results were discussed in the RI Report to characterize the nature and extent of impacts (Arcadis 2013a).

A screening level analysis for unrestricted use, including potential residential receptors, was conducted in the DTSC-approved RI Report and exceedances of the unrestricted residential screening levels were identified (Arcadis 2013a). Figures 2-18 and 2-19 present a comparison of arsenic and dioxin TEQ in Ponds 6, 7, 8, and North Pond with human health preliminary screening levels (PSLs), and Figures 2-20 and 2-21 present a comparison of arsenic and dioxin TEQ in the southern ponds with human health PSLs, respectively. Figure 2-22 presents a comparison of dioxin TEQ in the Riparian Areas with human health PSLs.

Conclusions from the RI Report are summarized below per AOI. These include constituents detected at concentrations greater than human health and/or ecological PSLs appropriate for unrestricted land use.

- OU-E Lowland Terrestrial Soil: metals (antimony, arsenic, barium, chromium, copper, lead, mercury, molybdenum, and zinc), TPHd, dioxins/furans, and PAHs were detected at concentrations greater than PSLs.
- OU-E Aquatic Area Sediment: metals (arsenic, barium, cadmium, chromium, cobalt, copper, lead, mercury, molybdenum, nickel, and zinc), PAHs, VOCs, dioxins/furans, PCBs, pesticides, and TPH were found at concentrations greater than PSLs.
- OU-E Groundwater: Metals (arsenic, barium, cobalt, copper, lead, molybdenum, nickel, thallium, and vanadium), PAHs, VOCs, dioxins/furans, PCBs, and TPH were found at concentrations greater than PSLs.

The RI Report recommended four of the five lowland terrestrial AOIs (Water Treatment and Truck Dump AOI, Sawmill #1 AOI, Compressor House and Lath Building AOI, and Powerhouse and Fuel Barn AOI) for further evaluation in the BHHERA. The RI Report recommended no further action for the Pond 8 Fill Area AOI, due to only a single zinc exceedance of the ecological PSL and no exceedances of human health PSLs. All 10 OU-E aquatic AOIs (Ponds 1 through 9, and the North Pond) were recommended for further evaluation in the BHHERA. The additional site investigation and risk assessment activities conducted for the BHHERA are further discussed in Section 2.6.

The OU-C and OU-D RI evaluated the nature and extent of constituents in the IRM and West of IRM AOC and assessed the risk associated with soil and groundwater conditions, as detailed in Section 2.4.4. The Riparian AOI was further evaluated during the investigation that accompanied the BHHERA. The purpose of the investigation was to provide a baseline human health and ecological risk assessment for OU-E and associated AOIs, which included the Riparian AOI. The COIs in the Riparian AOI that were investigated were metals (arsenic, barium, selenium, vanadium, and zinc) and PAHs (Arcadis 2015b). The nature and extent of constituents considered in the BHHERA are presented in Section 2.6. No additional investigation of dioxin in soil or sediment was conducted as part of the BHHERA investigation for the Riparian AOI (DTSC 2016).

#### 2.4.4 OU-C and OU-D IRM and West of IRM Soil and Groundwater Investigations and Risk Assessment

In accordance with the IARAP (Arcadis 2008b), soil excavation and in-situ groundwater treatment (biosparging and application of ORM) were conducted between 2008 and 2009 in the IRM and West of IRM AOIs. COI concentrations in non-excavated soil are generally below the screening levels. Slightly elevated TPHd concentrations remain in soil beneath the excavation area northwest of the MES and the excavation boundary in the vicinity of the Former Diesel AST (Arcadis 2011a).

The BHHERA evaluation provided in the DTSC approved OU-C and OU-D RI concluded that COI concentrations in soil at the IRM and West of IRM AOIs do not pose a risk to human health or the environment. The IRM and West of IRM AOIs were recommended for evaluation in this FS for fuel-related constituents, VOCs, and arsenic in groundwater (Arcadis 2011a).

## 2.5 Remedial Actions

### 2.5.1 Interim Remedial Measures

IRM activities as described in the *Interim Action Remedial Action Plan* (IARAP; Arcadis 2008b) and *Interim Action Completion Report* (Arcadis 2010a) were initiated in 2008 and completed in 2009. IRM activities include:

- Foundation removal and cap placement. Details regarding the demolition, investigation, and removal activities performed and the analytical results from the sampling are presented in the *Construction Completion Report* (Arcadis BBL 2007a). Additional details regarding the caps and their design and construction are provided in the Final Cap Design Memorandum, included as Appendix G of the *Construction Completion Report* (Arcadis BBL 2007a).
- Excavation of former fuel pipe that extended from the former Fuel Storage Shed to the Powerhouse (Arcadis 2008a).
- Excavation and disposal of soil impacted with metals near the former Compressor Houses, and excavation and onsite treatment of TPH-affected soil near the former

Compressor Houses. These activities are presented in the *Interim Action Completion Report, Operable Units C and E* (Arcadis 2010a).

- In-situ groundwater treatment for TPH [biosparging and addition of oxygen-releasing material (ORM) before backfilling] near the former Compressor Houses.
- Excavation and onsite treatment of TPH-affected soil within the IRM AOI and the West of IRM AOI. Excavation activities are presented in the *Interim Action Completion Report, Operable Units C and E* (Arcadis 2010a).
- In-situ groundwater treatment for TPH (biosparging and addition of ORM before backfilling) within the IRM AOI and the West of IRM AOI.
- Approximate capped areas in the OU-E Lowlands are presented on Figure 1-4.

### 2.5.2 2017 Remedial Actions

The OU-E RAW was developed to expedite remediation of certain AOCs to facilitate construction of the City's coastal trail and expedite remediation of the site. The AOCs included in the OU-E RAW are the Lowland Terrestrial AOC, the Ponds 1, 2, 3, and 4 (Southern Ponds) AOC, the Riparian AOC, and the Pond 7 AOC. The OU-E RAW included an evaluation of remedial alternatives and proposed excavation and disposal as the selected remedial action. The OU-E RAW and, therefore, the excavation and disposal remedial alternative, was approved by DTSC on 13 October 2016 (DTSC 2016). The approach for implementation was presented in the Final OU-C, OU-D, and OU-E Implementation Plan (RDIP; Kennedy Jenks 2017) and a summary of the completed remedial actions was presented in the RACR (Kennedy Jenks 2018a).

There were 12 remedial action areas (RAAs) in the Lowland Terrestrial AOC, four RAAs in the Riparian Area AOI, two RAAs in the Southern Ponds AOC, and one RAA in the Pond 7 AOC. Approximately 2,237 cubic yards were excavated from these RAAs. After the completion of excavation activities, residual COC concentrations are below the established remedial action goals. Additionally, residual COC concentrations at the Riparian Area AOI are below the residential screening criteria on a point-by-point basis, and therefore, the Riparian Area AOI was approved for NFA. EPCs for the remaining OU-E AOCs (Southern Ponds AOC, Pond 7 AOC, and Lowland Terrestrial AOC) were recalculated and compared to residential screening criteria. The Lowland Terrestrial AOC EPCs meet residential screening criteria, and therefore, the Lowland Terrestrial AOC was also approved for NFA for soil. Based on the recalculated EPCs, the Southern Ponds AOC and Pond 7 AOC were evaluated in the OU-E Feasibility Study and the OU-E RAP.

## 2.6 Baseline Risk Assessment

The RI Report and BHHERA were completed for the IRM and West of IRM AOIs as part of the OU-C and OU-D RI (Arcadis 2011a) and are not further discussed in this section. This section presents the nature and extent of constituents for the Riparian AOI based on additional sediment and porewater samples collected from the Riparian AOI as part of the OU-E BHHERA investigation.

In April 2013, additional sediment and porewater samples were collected from Ponds 1 through 9, the North Pond, and the Riparian AOI (Figures 2-23, 2-24, 2-25, and 2-26). Data collected in the additional BHHERA investigation were used in conjunction with RI data to provide an evaluation of potential risk in OU-E for reasonably anticipated future receptors, based on current land and assumed future land use presented in the *Mill Site Specific Plan* (Mill Site Coordinating Committee 2012; Figure 2-1). Human receptors evaluated in the terrestrial exposure area of OU-E included construction workers, maintenance/utility workers, passive (occasional) child and adult recreational visitors, frequent adult recreational visitors, and commercial/industrial workers (Figure 2-27). Human receptors in the combined aquatic exposure areas of OU-E included passive child and adult recreational visitors (Figure 2-28).

The OU-E BHHERA estimated exposure and characterized potential ecological risk in accordance with the CSM presented in the OU-E BHHERA and methods described in the *Site-Wide Risk Assessment Work Plan* (Site-Wide RAWP; Arcadis 2008c) and the OU-E BHHERA Work Plan (Arcadis 2013b). The BHHERA calculated EPCs for each COPC in each exposure area to inform the risk assessment. The EPC is the concentration of a COPC in an environmental medium to which a potential receptor might be exposed. The method of calculating the EPC varied based on the quantity of available data, as described in the following sections. A conservatively based 95% UCL on the arithmetic mean concentration was estimated using EPA's ProUCL 4.1 software to represent the EPC where sufficient data was available. ProUCL uses the maximum concentration when a 95% UCL cannot be calculated because of the data distribution. The EPC is then compared to the applicable remedial goal or used to calculate risk estimates.

The OU-E BHHERA included a hot-spot/residual risk and hazard analyses for the Lowland Terrestrial AOC, the Aquatic AOC, and the Riparian AOI. The Pond 8 Fill Area AOI was not included as part of the BHHERA dataset in response to DTSC comments on the BHHERA work plan, and due to the absence of COPCs above relevant screening levels. The results of the risk assessment are briefly summarized below:

- **Lowland Terrestrial AOI:** Results of the ERA for the terrestrial exposure area indicated that potential unacceptable risk for populations of plants, soil invertebrates, birds, and mammals is unlikely. Hazard Quotients (HQs) were generally less than one, or COPC EPCs were below site-specific background concentrations. Barium HQs for plants, invertebrates, and invertivorous mammals were greater than one, but were driven by a few samples located in a small area of the site, indicating potential population-level exposure is limited. Furthermore, the ERA concluded that exposure of individual receptors in the small area would not result in unacceptable effects to local populations.
- **Aquatic AOI:** The BHHERA evaluated all 10 aquatic AOIs. Ponds 1, 2, 3, and 4 were combined into a single Southern Ponds AOC, resulting in a total of seven aquatic AOCs as separate exposure areas in the BHHERA (Ponds 1 through 4, Pond 5, Pond 6, Pond 7, the North Pond, Pond 8, and Pond 9). Additionally, all ponds were evaluated as one exposure area (the Combined Aquatic AOC) under two exposure scenarios: assuming 50 days exposure per year and 12 days of exposure per year. Results of the ERA for combined aquatic exposure areas indicated that unacceptable risk is not likely for populations of plants, benthic organisms, birds, mammals, and amphibians exposed to site sediment and surface water. ERA results for ponds evaluated individually



indicated potential risk is not likely, with the exception of barium partitioning to porewater in Pond 7 sediment, which may pose a potential risk to benthic organisms based on comparison of porewater concentrations at locations Pond 7-01 [1,570 micrograms per liter ( $\mu\text{g/L}$ )], Pond 7-01 (1,935  $\mu\text{g/L}$ ), and DP-4.13 (1,780  $\mu\text{g/L}$ ) to the selected screening level of 1,000  $\mu\text{g/L}$ .

- **Riparian AOI:** Riparian Area AOI soil and groundwater were evaluated for human health risks in the BHHERA section of the DTSC approved OU-C and OU-D RI as part of the Open Space exposure unit (EU). The BHHERA concluded that ecological risk in the OU-D Riparian AOI is negligible. No further evaluation for dioxin/furan risk was performed in the BHHERA because invertebrates lack specific biochemical receptors essential to produce dioxin related toxicity (Céspedes et al. 2010; Hahn 2002; West et al. 1997). Dioxin toxicity is expressed via the aryl hydrocarbon receptor in vertebrates. However, invertebrates lack the aryl hydrocarbon receptor, and aryl hydrocarbon receptor homologues identified in invertebrates have been shown to not bind dioxin compounds (Céspedes et al. 2010; Hahn 2002; West et al. 1997). Furthermore, toxicity testing conducted on various invertebrate species has shown no toxicity associated with tissue concentrations up to 9.5 milligrams per kilogram (mg/kg) lipid (West et al. 1997).

Additional detail regarding the BHHERA risk assessments was provided in the OU-E FS (see Section 2.2.6 of the OU-E FS).

The results of the assessments informed the OU-E RAW and Remedial Action Implementation Plan (RDIP). The proposed remedial actions were completed in 2017, as summarized in the RACR and described in Section 2.5.2.

## Section 3: Remedial Action Objectives

---

This section identifies and evaluates the objectives and requirements of remediation which will drive the development and screening of remedial alternatives. Laws and regulations [applicable, relevant, and appropriate requirements (ARARs)] that may apply to the remediation were identified in the OU-E FS.

### 3.1 Applicable or Relevant and Appropriate Requirements

Comprehensive Environmental Recovery, Cleanup, and Liability Act (CERCLA) and its regulations [40 Code of Federal Regulations (CFR) 300 et seq., referred to as the National Contingency Plan (NCP)] provide an established, and generally accepted, framework for evaluating and remediating industrial sites (NCP 2014; EPA 1990). Under the NCP, remedial actions must attain (or justify the waiver of) any federal or more stringent state environmental standards and facility citing laws that are “applicable or relevant and appropriate.” These regulatory requirements are known as ARARs. The ARARs are used to develop quantitative RAOs, determine the extent of site cleanup, and govern the implementation and operation of the selected alternatives.

Identification of ARARs must be completed on a site-specific basis and involves a two-part analysis: first, a determination of whether a given requirement is applicable and then, if it is not applicable, a determination of whether it is nevertheless both relevant and appropriate. Federal, state, and local ARARs can be divided into the following categories:

- **Chemical-specific ARARs:** Chemical-specific or ambient requirements include those laws and regulations that govern the release to the environment of materials possessing certain chemical or generally set health- or risk-based concentration limits, or discharge limitations for specific hazardous substances that may be found in, or discharged to, the ambient environment. If, in a specific situation, a chemical is subject to more than one discharge or exposure limit, the more stringent of the requirements should generally be applied.
- **Performance, design, or action-specific ARARs:** Action-specific ARARs consist of requirements that define acceptable handling, treatment, and disposal procedures for hazardous substances. These ARARs generally set performance, design, or other similar action-specific controls or restrictions on particular kinds of activities related to management of hazardous substances or pollutants. These requirements are triggered by the particular remedial activities that are selected to accomplish the cleanup remedy.
- **Location-specific ARARs:** Location-specific ARARs are those requirements that relate to the geographical or physical position of the site, rather than the nature of the contaminants or the proposed site remedial actions. These requirements may limit the type of remedial action that can be implemented and may impose additional constraints on the cleanup action.

A requirement may not meet the definition of an ARAR but may still be useful in determining whether to take action at a site or to what degree action is necessary. Some requirements are

called to-be-considered (TBC) criteria. The TBC requirements are non-promulgated advisories or guidance issued by federal, state, or local government that are not legally binding, but may provide useful information or recommend procedures for remedial action.

ARARs and TBCs have been compiled for the soil, sediment, and groundwater in the AOCs addressed in this RAP using federal, state, and local statutes, regulations, and guidance listed in Table 3-1. Note that the ultimate agency determination of requirements and conditions will be performed as part of the approval of permits requested for implementation of the selected alternative in response to a specific design or work plan.

### 3.2 Remedial Action Objectives

RAOs are medium-specific goals for protecting human health and the environment that, in consideration with the estimated remedial scope and cost for screening alternatives and existing data, will be used to define the scope of remediation work to be proposed in the forthcoming RAP. Risk-based-target levels (RBTLs) were identified by DTSC (DTSC 2014), as discussed in the OU-E RAW (Arcadis 2016). Where applicable, they are presented in Table 3-2 and will be used to evaluate site conditions. The RBTLs will be compared to post-remedy exposure estimates (i.e., 95% UCLs) to confirm that site conditions are protective of human and ecological receptors.

RAOs are guidelines used in the development of potential remedial action alternatives and selection of a proposed remedial action. The RAOs presented herein have been developed based on the current environmental conditions and anticipated future use of the site.

- Prevent the ingestion of and incidental contact with COCs in soil that exceed Remedial Goals established in the RAP by future users of the former Mill site. The relevant human exposure pathways for human receptors in the terrestrial exposure area include: incidental soil ingestion, dermal contact with soil, inhalation of particulates, and contact with groundwater (construction and utility workers only).
- Prevent the ingestion of and incidental contact with chemicals of concern in sediments that exceed Remedial Goals established in the RAP by future users of the former Mill site. The relevant human exposure pathways for the passive recreator receptor in the aquatic area included: incidental sediment ingestion, dermal contact with sediment, and contact with surface water.
- For the AOC(s) with COC-impacted groundwater, provide remediation alternative that will promote mitigation of COC-impacted groundwater to ultimately achieve North Coast Regional Water Quality Control Board (RWQCB) water quality objectives (WQOs).

### 3.3 Chemical Specific Remedial Goals

Chemical-specific remedial goals will be used to evaluate remedial action effectiveness following implementation and identify appropriate foreseeable future land use. Draft remedial goals were presented in the OU-E FS. Consistent with DTSC guidance for risk-based cleanups, chemical-specific remedial action goals will be applied based on a conservative estimate of the

average concentration (e.g., 95% UCL on the mean) of a COC across an exposure area. This concentration is referred to as the EPC.

Media-specific numeric remedial goals for are presented in Table 3-2 for the COCs recommended for remedial action within the scope of the RAP. The remedial goals for groundwater at the site are based on WQOs set forth in the Water Quality Control Plan for the North Coast Region (“Basin Plan”; North Coast RWQCB 2011, 2015). The background level of arsenic at this site is above the WQO for arsenic. Therefore, the background concentration for arsenic for the Former Georgia-Pacific Mill Site is the Remedial Goal for this COC. As presented in the Background Metals Report, background concentrations of arsenic in California soil range from 0.6 mg/kg to 31 mg/kg (Arcadis BBL 2007d). Groundwater COCs in OU-E (arsenic, barium, TPHd, and TPHg) are not associated with indoor air inhalation risk and do not have screening levels protective of the soil vapor/indoor air pathway calculated by the San Francisco Bay Regional Water Quality Control Board (SFRWQCB 2013); therefore, soil vapor is not a media of concern in OU-E.

The primary remedial goals for soil and sediment COCs within the OU-E AOIs are protective of residential users and support the unrestricted use of an AOI. Alternative goals are included for the commercial, construction, and utility worker; and for passive and the occasional recreator. The primary remedial goals for soil and sediment COCs are discussed below.

- **Dioxins:** A residential dioxin soil remedial goals of 50 pg/g was selected based on the DTSC HHRA Note 2 (DTSC 2009). The DTSC HHRA note presents a suite of suggested dioxin-TEQ soil remedial goals that have been developed for consideration at mitigation sites in California for the protection of human health.
- **Metals (Arsenic):** The background concentration for arsenic for the Former Georgia-Pacific Mill Site (10 mg/kg) is the Remedial Goal for this COC.

## Section 4: Remedial Alternatives and Selected Remedial Actions

---

Remedial alternatives for OU-E were presented and evaluated in the approved Feasibility Study, Operable Unit E (Kennedy Jenks 2019a). The OU-E FS evaluated five AOCs:

- Ponds 1-4 (the Southern Ponds) Aquatic Sediment
- North Pond and Pond 6 Aquatic Sediment
- Pond 7 Aquatic Sediment
- Pond 8 Aquatic Sediment
- OU-E Groundwater.

Remedial alternatives were developed for each AOC and screened based on technical implementability on the site. Preliminary screening of retained remedial alternatives was based on implementability, effectiveness, and cost. Retained remedial alternatives were further evaluated in accordance with EPA and DTSC guidance (discussed in Section 6 of the OU-E FS). Following evaluation based on these nine criteria (see Section 4.1.1), a preferred remedial alternative was selected for each AOC. Alternatives evaluated, as well as a summary of the conclusions, are presented in Tables 4-1 through 4-5.

Modifying criteria of state support/agency acceptance and community acceptance will be considered after receipt of public comments on this Remedial Action Plan.

### 4.1 Summary of Evaluated Remedial Alternatives and Recommendations

The five AOCs that were evaluated in the OU-E FS and the remedial alternatives considered are summarized as follows:

- Southern Ponds (Ponds 1-4) Aquatic Sediment
  - No Action
  - Institutional Controls
  - Vegetated Soil Cover
  - Excavation and Disposal
  - Vegetated Sediment Cover

- Pond 7 Aquatic Sediment
  - No Action
  - Institutional Control / Containment
  - Vegetated Soil Cover
  - Excavation and Disposal
  - Vegetated Sediment Cover
- North Pond and Pond 6 Aquatic Sediment
  - No Action
  - Institutional Control / Containment
  - Vegetated Soil Cover
  - Excavation and Disposal
  - Vegetated Sediment Cover
- Pond 8 Aquatic Sediment
  - No Action
  - Institutional Control / Containment
  - In-situ Soil Mixing
  - Excavation and Disposal
  - Vegetated Sediment Cover
  - Vegetated Soil Cover
- OU-E Groundwater
  - No Action
  - Restricted Use
  - MNA
  - Enhanced Aerobic Bioremediation
  - Enhanced Anaerobic Bioremediation

## 4.1.1 Evaluation Criteria

Remedial technologies retained through preliminary screening were further developed and evaluated against applicable remedial alternative screening criteria. In accordance with EPA FS and DTSC RAP guidance, the nine criteria described in the sections below were used to evaluate remedial alternatives (EPA 1988; DTSC 1995). For an alternative to be selected, it must meet the first two threshold Criteria, which are: 1) overall protection of human health and the environment; and 2) compliance with ARARs. Criteria 3 through 7 are the five primary balancing criteria that provide comparisons between the alternatives and identify tradeoffs between them; Criteria 8 and 9 are the two modifying criteria that consider acceptance by the state and local community.

### 4.1.1.1 Threshold Screening Criteria

Threshold screening criteria are those considered absolutely necessary for an alternative to be considered sound. These criteria reflect the overall protection of human health and the environment and compliance with ARARs. Threshold criteria are typically considered “yes or no” criteria. If a screened technology fails a threshold criterion, the technology is considered as not viable for further consideration.

#### 4.1.1.1.1 *Overall Protection of Human Health and the Environment*

All remedial alternatives being evaluated must be protective of human health and the environment. No alternative should result in unacceptable levels of risk to onsite or offsite receptors during or after implementation, drawing upon the assessment of other evaluation criteria, including short- and long-term effectiveness and compliance with the RAOs. This component of the alternative evaluation assesses how potential exposure pathways are eliminated, reduced, or controlled through removal, treatment, engineering controls, or institutional controls.

#### 4.1.1.1.2 *Compliance with ARARs*

The remedial alternatives must be evaluated to determine whether they comply with ARARs under federal environmental laws and state environmental or facility siting laws, or whether there are grounds for a waiver. ARARs are presented in Section 3.

### 4.1.1.2 Balancing Criteria

Balancing criteria represent a combination of technical measures and management controls for addressing the environmental issues at the site. These criteria have gradations in value. The balancing screening criteria emphasize short- and long-term effectiveness; implementability; cost; and reductions of toxicity, mobility, or volume through treatment. The balancing criteria also consider the preference for treatment as a principal element and the bias against offsite land disposal of untreated waste.

#### 4.1.1.2.1 *Long-Term Effectiveness and Permanence*

The long-term effectiveness and permanence screening criterion evaluates the ability of an alternative to perform intended functions such as containment, diversion, removal, destruction

or treatment, and the permanence of the remedy. This criterion also assesses protection of human health and the environment after the RAOs have been met (EPA 1988). In accordance with NCP guidance, the long-term effectiveness screening criterion includes the magnitude of residual risk from any untreated waste or treatment residuals remaining at the conclusion of remediation activities, and the adequacy and reliability of controls (such as containment systems and institutional controls) that are necessary to manage treatment residuals and untreated waste. This criterion may be evaluated by design specifications or performance evaluation.

#### **4.1.1.2.2 Reduction of Toxicity, Mobility, or Volume through Treatment**

The reduction of toxicity, mobility, and volume screening criterion evaluates the degree to which an alternative employs recycling or treatment options that reduce toxicity, mobility, or volume, including how treatment is used to address principal threats potentially posed by the site. Factors considered for this criterion include treatment process and volume of materials to be treated; ability of the treatment to reduce the toxicity, mobility, or volume of contamination; nature and quantity of residuals that would remain after treatment; relative amount of hazardous substances and/or constituents that would be destroyed, treated, or recycled; and the degree to which the treatment is irreversible (EPA 1988).

#### **4.1.1.2.3 Short-Term Effectiveness**

The short-term effectiveness screening criterion assesses the short-term impacts of alternatives by considering short-term risks that may be posed to the public and the potential impacts on workers during remedial action implementation. This criterion also evaluates the effectiveness and reliability of protective measures, potential impacts on the environment and the effectiveness and reliability of mitigative measures, and amount of time until protection is achieved (EPA 1988).

#### **4.1.1.2.4 Implementability**

The implementability screening criterion evaluates the technical and administrative feasibility of implementing the remedial alternative, including the availability of various services and materials required for implementation (EPA 1988). Implementability depends on factors such as constructability (e.g., physical setting, permitting, disposal options), duration of work, reliability of the technology, ease of operation, availability of services and materials, and ability to monitor effectiveness (EPA 1988).

#### **4.1.1.2.5 Cost**

The cost screening criterion compares the anticipated approximate costs, direct (construction and materials) and indirect (engineering and legal) capital costs, as well as O&M costs. O&M costs may include operating labor, energy, chemicals, and sampling and analysis. O&M assumptions for each alternative are noted in the text. These costs were estimated with an anticipated accuracy between -30 to +50 (EPA 1988), and are represented in 2017 dollars applying 30-year net present value for future costs where necessary.



#### **4.1.1.3 Modifying Criteria**

Modifying criteria, which include state (support agency) and community acceptance, will be evaluated after submission of the FS to DTSC and after submittal of a RAP and receipt of public comments. The modifying criteria are described below.

##### **4.1.1.3.1 State Support/Agency Acceptance**

This criterion indicates whether, based on current knowledge of regulations and agency mandates, the applicable regulatory agencies would agree with the preferred alternative. The rankings listed in the sections below are based on preliminary input from agency meetings and knowledge of regulatory mandates. Actual assessment of regulatory agency acceptance is dependent on comments received during the agency review and public comment periods.

##### **4.1.1.3.2 Community Acceptance**

This criterion indicates whether community concerns are addressed by the remedy. Each alternative is evaluated in terms of currently available public input and the anticipated public reaction to the alternative but is considered preliminary. However, actual assessment of community acceptance is dependent on comments received during public comment period of the draft RAP.

#### **4.1.1.4 Other Criteria**

California Health and Safety Code Section 25356.1(d) also outlines six additional criteria, which need to be addressed for the recommended remedial alternative. As these criteria are addressed within the nine EPA criteria, a separate analysis was not conducted.

#### **4.1.2 Ponds 1-4 (Southern Ponds)**

As presented in Section 2.2.1.5, the COCs in the Southern Ponds AOC are dioxins and arsenic. A remedial action was completed in 2017 in accordance with approved OU-E RAW. Approximately 45 cy of sediment were excavated over an area of 800 square feet (sf) and disposed at an appropriate facility. Confirmation sampling was performed to confirm that concentrations at the excavation limits are below the not to exceed remedial goals included in the OU-E RAW. A summary of implementation and confirmation sample results are presented in the RACR. Remedial alternatives for Ponds 1-4 were evaluated in the OU-E FS.

Remedial alternatives evaluated in the OU-E FS for aquatic sediment in Ponds 1-4 included the following:

- No Action: A baseline to which other remedial technologies are compared.
- Institutional Controls: Containment, land use controls, sediment management, and long-term operations and management.
- Vegetated Soil Cover: Construction of an upland vegetated cover to cover each individual pond to restrict exposure of potential receptors to affected media by limiting potential direct contact with affected sediment or infiltration of water.

- Excavation and Disposal of Sediment: Excavation and offsite disposal of sediment in Ponds 1-4, which amounts to approximately 7,000 cy of sediment.
- Construction of a Vegetated Sediment Cover: Construction of a vegetated wetland cover to cover each individual pond to restrict exposure of potential receptors to affected media by limiting potential direct contact with affected sediment or infiltration of water.

Based on the analysis presented in the OU-E FS, Institutional Controls were selected as the preferred alternative for the Southern Ponds AOC. Although it is associated with a slightly lower reduction of toxicity, mobility, and volume, institutional controls provide adequate control of potential exposure pathways for future receptors. The benefits of a physical cover were offset by the effort and disruption required for implementation and potentially regular O&M. The benefits of Excavation and Disposal were offset by the effort and disruption required for implementation and the need to transport and dispose the sediment at a landfill. The cost difference between the alternatives was not justified by limited benefits of the Vegetated Soil Cover or Excavation and Disposal alternatives. Additionally, sediment COC concentrations and bioavailable fractions were significantly reduced by sediment removal performed in 2017 and are expected to continue to decline naturally through existing biological and geochemical processes.

The institutional controls option provides land use controls which limit land use and control activities in areas where the risk from one or more exposure pathways is deemed unacceptable. The land use controls will also provide design criteria for development within the restricted area. A Soil Management Plan (SMP) will also be developed to provide detailed procedures for sediment disturbing activities and describe required sampling and criteria for reuse of disturbed sediment. The land use controls and SMP will be consistent with foreseeable future site use. Notification to DTSC and sediment removal may occur as part of future redevelopment activities and changes in use to achieve acceptable risk for the changed conditions.

#### 4.1.3 Pond 7

As presented in Section 2.2.1.6, the COCs in the Pond 7 AOC are dioxins, barium, and arsenic. A remedial action was completed in 2017 in accordance with the approved OU-E RAW. Approximately 708 cy of sediment were excavated over an area of 5,500 sf and disposed of at an appropriate facility. Confirmation sampling was performed to confirm that concentrations at the excavation limits are below the not to exceed remedial goals included in the OU-E RAW. A summary of implementation and confirmation sample results are presented in the RACR.

Residual concentrations in five confirmation samples collected from the side of the Mill Pond Dam along the southern wall are above the unrestricted use goal but below the not-to-exceed sediment goals established in the RAW (between 93 and 350 pg/g). An area of approximately 5 feet wide and 180 feet long along the southern perimeter of the pond where concentrations remain above unrestricted use goals is assumed as the new RAA for Pond 7.

Remedial alternatives evaluated in the OU-E FS for aquatic sediment in Pond 7 included the following:

- No Action: A baseline to which other remedial technologies are compared.

- Institutional Control / Containment: Containment, land use controls, sediment management, and long-term operations and maintenance.
- Vegetated Soil Cover: Construction of an upland vegetated cover to cover the pond to restrict exposure of potential receptors to affected media by limiting potential direct contact with affected sediment or infiltration of water.
- Excavation and Disposal of Sediment: Excavation and offsite disposal of sediment in Pond 7, which amounts to approximately 900 cy of sediment.
- Construction of a Vegetated Sediment Cover: Construction of a vegetated wetland cover to cover the pond to restrict exposure of potential receptors to affected media by limiting potential direct contact with affected sediment or infiltration of water.

Based on the analysis presented in the OU-E FS, Institutional Control / Containment were selected as the preferred alternative for Pond 7 aquatic sediment. Although it was associated with a slightly lower reduction of toxicity, mobility, and volume, institutional control / containment provide adequate control of potential exposure pathways for future receptors. The benefits of a physical cover were offset by the effort and disruption required for implementation and potentially regular O&M, as well as the disturbance of the newly-created wetland establishment area. The benefits of Excavation and Disposal were offset by the effort and disruption required for implementation and the need to transport and dispose the sediment at a landfill. The cost difference between the alternatives was not justified by limited benefits of the Vegetated Soil Cover or Excavation and Disposal alternatives. Additionally, sediment COC concentrations and bioavailable fractions were significantly reduced by sediment removal performed in 2017 and are expected to continue to decline naturally through existing biological and geochemical processes.

The institutional control / containment option provides land use controls which limit land use and control activities in areas where the risk from one or more exposure pathways is deemed unacceptable. The land use controls will also provide design criteria for development within the restricted area. An SMP will also be developed to provide detailed procedures for sediment disturbing activities and describe required sampling and criteria for reuse of disturbed sediment. The land use controls and SMP will be consistent with foreseeable future site use. Notification to DTSC and sediment removal may occur as part of future redevelopment activities and changes in use to achieve acceptable risk for the changed conditions.

The existing beach berm will continue to provide sediment containment in this alternative. The beach berm will be inspected annually and maintenance will be completed as needed, and modification of the beach berm will be restricted by institutional controls.

#### 4.1.4 North Pond and Pond 6

As presented in Section 2.2.1.7, the COCs in the North Pond and Pond 6 AOC are dioxins and arsenic. Remedial alternatives evaluated in the OU-E FS for aquatic sediment in Pond 6 and the North Pond included the following:

- No Action: A baseline to which other remedial technologies are compared.

- Institutional Control / Containment: Containment, land use controls, sediment management, and long-term operations and maintenance.
- Vegetated Soil Cover: Construction of an upland vegetated cover to cover each pond to restrict exposure of potential receptors to affected media by limiting potential direct contact with affected sediment or infiltration of water.
- Excavation and Disposal of Sediment: Excavation and offsite disposal of sediment in the North Pond and Pond 6, which amounts to approximately 2,200 cy of sediment.
- Construction of a Vegetated Sediment Cover: Construction of a vegetated wetland cover to cover each pond to restrict exposure of potential receptors to affected media by limiting potential direct contact with affected sediment or infiltration of water.

Based on the analysis presented in the OU-E FS, Institutional Control / Containment were selected as the preferred alternative for aquatic sediment in the North Pond and Pond 6. Although it was associated with a slightly lower reduction of toxicity, mobility, and volume, institutional control / containment provide adequate control of potential exposure pathways for future receptors. The benefits of a physical cover were offset by the effort and disruption required for implementation and potentially regular O&M. The benefits of Excavation and Disposal were offset by the effort and disruption required for implementation and the need to transport and dispose the sediment at a landfill. The cost difference between the alternatives was not justified by limited benefits of the Vegetated Soil Cover or Excavation and Disposal alternatives. Additionally, sediment COC concentrations and bioavailable fractions are expected to continue to decline naturally through existing biological and geochemical processes.

The institutional control / containment option provides land use controls which limit land use and control activities in areas where the risk from one or more exposure pathways is deemed unacceptable. The land use controls will also provide design criteria for development within the restricted area. An SMP will also be developed to provide detailed procedures for sediment disturbing activities and describe required sampling and criteria for reuse of disturbed sediment.

The land use controls and SMP will be consistent with foreseeable future site use. Notification to DTSC and sediment removal may occur as part of future redevelopment activities and changes in use to achieve acceptable risk for the changed conditions.

The existing beach berm will continue to provide sediment containment in this alternative. The beach berm will be inspected annually and maintenance will be completed as needed, and modification of the beach berm will be restricted by institutional controls.

Additional sediment sampling activities were completed in 2019 in Pond 6, North Pond, and Pond 8 per DTSC request (Kennedy Jenks 2020b; DTSC 2020b). Data collected were consistent with or lower than past results and the report concluded that the additional data continued to support the remedial alternative recommended in the OU-E FS.

#### 4.1.5 Pond 8

As presented in Section 2.2.1.8, the COCs in the Pond 8 AOC are dioxins and arsenic.

Remedial alternatives evaluated in the OU-E FS for aquatic sediment in Pond 8 included the following:

- No Action: A baseline to which other remedial technologies are compared.
- Institutional Control / Containment: Containment, land use controls, sediment management, and long-term operations and maintenance.
- In-situ Soil Mixing of Sediment: Treating sediment in place through stabilization by the addition of binders and Portland cement to restrict exposure of potential receptors to affected media by limiting potential direct contact with affected sediment or infiltration of water.
- Vegetated Sediment Cover: Construction of an upland vegetated cover to cover the pond to restrict exposure of potential receptors to affected media by limiting potential direct contact with affected sediment or infiltration of water.
- Excavation and Disposal of Sediment: Excavation and offsite disposal of sediment in Pond 8, which amounts to approximately 106,000 cy of sediment.
- Construction of a Vegetated Sediment Cover: Construction of a vegetated wetland cover to cover the pond to restrict exposure of potential receptors to affected media by limiting potential direct contact with affected sediment or infiltration of water.

Based on the analysis presented in the OU-E FS, the Institutional Control / Containment alternative is the preferred alternative for the Pond 8 AOC as it provides adequate control of potential exposure pathways for future receptors without the destruction of wetlands and associated mitigation. This alternative also allows Pond 8 to continue to receive and treat stormwater from the site and the City. Although it was associated with lower reduction of toxicity, mobility, and volume, institutional control / containment provide adequate control of potential exposure pathways for future receptors. The benefits of a physical cover were offset by the effort and disruption required for implementation and potentially regular O&M. The benefits of Excavation and Disposal were offset by the effort and disruption required for implementation and the need to transport and dispose the sediment at a landfill. The cost difference between the alternatives was not justified by limited benefits of the Vegetated Soil Cover or Excavation and Disposal alternatives.

The institutional control / containment option provides land use controls which limit land use and control activities in areas where the risk from one or more exposure pathways is deemed unacceptable. The land use controls will also provide design criteria for development within the restricted area. An SMP will also be developed to provide detailed procedures for sediment disturbing activities and describe required sampling and criteria for reuse of disturbed sediment.

The land use controls and SMP will be consistent with foreseeable future site use. Notification to DTSC and sediment removal may occur as part of future redevelopment activities and changes in use to achieve acceptable risk for the changed conditions.

To address DSOD requirements, the Mill Pond Dam will be modified to add a soil buttress at the northeastern end and a rock slope protection at the crib wall near the ocean. These features are not expected to require significant soil removal or destruction of habitat. The dam modifications will not affect existing sediment, and the Mill Pond would continue to receive and treat stormwater from the site and the City. The beach berm will continue to protect the Mill Pond Dam from damage due to ocean intrusion in the lowland. This alternative will include regular inspection and maintenance of both the Mill Pond Dam and the beach berm, including vegetation control on the beach berm, as well as annual inspection, maintenance, vegetation control, and periodic survey of the Mill Pond Dam. The design life of proposed repairs for the Mill Pond Dam is estimated to be over 100 years as the maximum credible earthquake and maximum probable flood are used for design.

Concentrations of COCs in sediment in Pond 8 were shown to represent limited risk to receptors for the reasonable foreseeable use in the OU-E BHHERA. Sediment COC concentrations and bioavailable fractions are expected to continue to decline naturally through existing biological and geochemical processes. Additional sediment sampling activities were completed in 2019 in Pond 6, North Pond, and Pond 8 per DTSC request (Kennedy Jenks 2020b; DTSC 2020b). Data collected were consistent with or lower than past results and the report concluded that the additional data continued to support the remedial alternative recommended in the OU-E FS.

#### 4.1.6 Groundwater

As presented in Section 2.2.1.9, the COCs in the OU-E Groundwater AOC are TPHd and TPHg within the IRM and West of IRM AOIs and barium in the OU-E Lowlands AOI. OU-E Lowlands AOC groundwater is included in the FS due to barium detected in MW-4.1.

Remedial alternatives evaluated in the OU-E FS for OU-E groundwater included the following:

- No Action: A baseline to which other remedial technologies are compared.
- Restricted use: Provision of land use controls prohibiting use of groundwater to eliminate exposure to COCs.
- MNA and Institutional Controls: Monitoring and documentation of the natural decline of COC concentrations until further monitoring is deemed unnecessary to demonstrate achievement of RAOs in a reasonable time frame. Land use controls would restrict use of groundwater until WQOs are achieved or agency acceptance is for unrestricted use is received.
- Enhanced Aerobic Bioremediation: Subsurface delivery of oxygen to enhance the aerobic biological degradation of COCs. Land use controls would restrict use of groundwater until WQOs are achieved or agency acceptance is for unrestricted use is received.
- Enhanced Anaerobic Bioremediation: Subsurface delivery of an anaerobic electron acceptor such as sulfate to enhance the anaerobic biological degradation of COCs. Land use controls would restrict use of groundwater until WQOs are achieved or agency acceptance is for unrestricted use is received.

Based on the analysis presented in the OU-E FS, MNA combined with institutional controls is the recommended alternative for the OU-E Groundwater AOC. Although the MNA alternative was associated with a slightly lower reduction of toxicity, mobility, and volume, MNA provides adequate mitigation of potential exposure pathways for future receptors. The benefits of the active remediation alternatives were offset by the short-term effectiveness and potential implementability issues, and the cost difference was not justified by significant benefits and was associated with a degree of uncertainty.

The MNA alternative addresses both fuel-related constituents present in groundwater in the IRM and West of IRM AOIs and barium present in OU-E Lowlands AOC groundwater. This alternative monitors and documents the natural decline in COC concentrations beyond RAP submittal until further monitoring is deemed unnecessary to demonstrate achievement of RAOs in a reasonable timeframe.

This alternative also places LUCs on the AOC, prohibiting the use of groundwater in the vicinity of affected areas to restrict exposure to COCs. Groundwater use will be restricted until WQOs are achieved or agency approval for unrestricted use is received. Note that in some areas of the site, COC concentrations are below drinking water standards or other use criteria even though above WQOs. Use of such water may be deemed acceptable on a case by case basis.

Under this alternative, natural attenuation by existing physical, biological, and geochemical processes will reduce the concentrations in groundwater within a reasonable timeframe. Monitoring will be performed to evaluate changes in COC concentrations until RAOs can be met. Performance criteria for MNA are to achieve stable or decreasing trends in COC concentrations, such that WQOs will be attained in a reasonable time frame. As appropriate, detailed discussion of additional data collection and trend analysis for this AOC will be provided in ongoing semiannual groundwater monitoring reports.

The monitoring well network and ongoing groundwater monitoring program are described in the *Operable Unit D and Operable Unit E Groundwater Operation & Maintenance Plan* (OU-D/E Groundwater O&M Plan; Kennedy Jenks 2020a) approved by DTSC on 30 March 2020 (DTSC 2020a). Liquid-phase hydrocarbons (LPH) have been detected in MW-5.5 in the IRM AOI. However, residual free product in MW-5.5 has decreased since September 2018 and is not contributing to dissolved phase hydrocarbons downgradient based on monitoring results at MW-5.20. MW-5.5 and downgradient well MW-5.20 are included in the OU-D/E Groundwater O&M Plan and will continue to be monitored to assess LPH in MW-5.5.

## Section 5: Reporting and Public Participation

---

### 5.1 Reporting

The OU-D/E Groundwater O&M Plan included in the selected remedial alternative for OU-E groundwater specifies monitoring, evaluation, and reporting requirements associated with the natural attenuation remedy. Reporting requirements associated with LUCs will be defined in each LUC.

### 5.2 Public Participation

The public participation requirements for the RAP process include the following:

- Developing a Public Participation Plan.
- Holding a minimum 30-day public comment period.
- Publishing a public notice of the availability of the draft RAP for public review and comment in a local newspaper of general circulation.
- Posting a notice of the availability of the draft RAP for public review and comment at the Site.
- Distributing a fact sheet to parties on the site mailing list describing the proposed remedy and the availability of the draft RAP for public comment.
- Making the draft RAP and other supporting documents (i.e., CEQA document) available for public review at the DTSC office and in the local information repositories.
- Conducting a public meeting during the public comment period.
- Responding to public comments received on the draft RAP and CEQA documents.

### 5.3 Schedule

The OU-D/E Groundwater O&M Plan has been approved by DTSC (DTSC 2020a) and includes a schedule for natural attenuation monitoring and reporting. The OU-D/E Groundwater O&M Plan is currently being implemented. Land use controls will be developed following approval of this RAP and can be completed within approximately 1 year of approval. Modifications to the Mill Pond Dam include additional planning and permitting with the DSOD, the USACE, the City, the CCC, and other state and federal resource agencies. These activities may require sequential and iterative approvals of plans with each agency and will be completed based on responses from the various agencies.



## Section 6: References

---

- Acton•Mickelson•Environmental, Inc. (AME). 2005. Work Plan for Additional Site Assessment, Georgia-Pacific California Wood Products Manufacturing Facility, 90 West Redwood Avenue, Fort Bragg, California. Prepared for Georgia-Pacific Corporation. Project No. 16017.07. Acton•Mickelson•Environmental, Inc. June.
- AME. 2006a. Dioxin Sampling and Analysis Report, Georgia-Pacific California Wood Products Manufacturing Facility, 90 West Redwood Avenue, Fort Bragg, California. Prepared for Georgia-Pacific Corporation. Project No. 16017.08. Acton•Mickelson•Environmental, Inc. July.
- AME. 2006b. Data Transmittal Report, Georgia-Pacific California Wood Products Manufacturing Facility, 90 West Redwood Avenue, Fort Bragg, California. Prepared for Georgia-Pacific Corporation. Project No. 16017.08. Acton•Mickelson•Environmental, Inc. 14 August.
- Arcadis. 2008a. Fuel Oil Line Removal Report, Former Georgia-Pacific Wood Products Facility, Fort Bragg, California. Prepared for Georgia-Pacific LLC. March.
- Arcadis. 2008b. Final Interim Action Remedial Action Plan and Feasibility Study, Former Georgia-Pacific Wood Products Facility, Fort Bragg, California. Prepared for Georgia-Pacific LLC. June.
- Arcadis. 2008c. Site-Wide Risk Assessment Work Plan (Site-Wide RAWP), Former Georgia-Pacific Wood Products Facility, Fort Bragg, California. Prepared for Georgia-Pacific LLC. Arcadis U.S., Inc. May.
- Arcadis. 2009. Data Summary Report, Operable Unit E Pond Sediment, Former Georgia-Pacific Wood Products Facility, Fort Bragg, California. Prepared for Georgia-Pacific LLC. May.
- Arcadis. 2010a. Interim Action Completion Report, Operable Units C & E, Former Georgia-Pacific Wood Products Facility, Fort Bragg, California. Prepared for Georgia-Pacific LLC. Arcadis U.S., Inc. April.
- Arcadis. 2010b. Site Investigation Work Plan, Operable Unit E – Upland, Former Georgia-Pacific Wood Products Facility, Fort Bragg, California. Prepared for Georgia-Pacific LLC. Arcadis U.S., Inc. May.
- Arcadis. 2010c. Site Investigation Summary and Step-out Evaluation, Operable Unit E, Former Georgia-Pacific Wood Products Facility, Fort Bragg, California. Prepared for Georgia-Pacific LLC. October.
- Arcadis. 2011a. Remedial Investigation Operable Units C and D, Former Georgia-Pacific Wood Products Facility, Fort Bragg, California. Prepared for Georgia-Pacific LLC. Arcadis U.S., Inc. April. Revised February 2011.

- Arcadis. 2011b. Environmentally Sensitive Habitat Areas Delineation Report, Former Georgia-Pacific Wood Products Facility, Fort Bragg, California. Prepared for Georgia-Pacific LLC. April.
- Arcadis. 2011c. Data Summary Report – Additional Investigation Pond 8 Sediment, Former Georgia-Pacific Wood Products Facility, Fort Bragg, California. Prepared for Georgia-Pacific LLC. Arcadis U.S., Inc. April. Revised February 2011.
- Arcadis 2011d. Mill Pond Complex Restoration Draft Conceptual Design, Former Georgia-Pacific Wood Products Facility, Fort Bragg, California. Prepared for Georgia-Pacific LLC, June.
- Arcadis. 2011e. Operable Unit E Upland – Site Investigation Sampling Summary, Former Georgia-Pacific Wood Products Facility, Fort Bragg, California. Prepared for Georgia-Pacific LLC. Arcadis U.S., Inc. 2 March.
- Arcadis. 2012a. Feasibility Study, Operable Units C and D, Former Georgia-Pacific Wood Products Facility, Fort Bragg, California. Prepared for Georgia-Pacific LLC, January.
- Arcadis. 2012b. Mill Pond (Pond 8) Geotechnical and Chemical Characterization Results, Former Georgia-Pacific Wood Products Facility, Fort Bragg, California. Prepared for Georgia-Pacific LLC. December.
- Arcadis. 2013a. Final Remedial Investigation Report Operable Unit E (RI Report), Former Georgia-Pacific Wood Products Facility, Fort Bragg, California. Prepared for Georgia-Pacific LLC. January.
- Arcadis. 2013b. Revised Baseline Human Health and Ecological Risk Assessment (BHHERA) Work Plan – Operable Unit E (OU-E) Addendum, Former Georgia-Pacific Wood Products Facility, Fort Bragg, California. Prepared for Georgia-Pacific LLC. February.
- Arcadis. 2013c. Comprehensive Monitoring Plan Update No. 6, Former Georgia-Pacific Wood Products Facility, 90 West Redwood Avenue, Fort Bragg, California. Prepared for Georgia-Pacific LLC. 6 November.
- Arcadis. 2014. Mill Site Dam Supplemental Site Investigation Work Plan, Former Georgia-Pacific Wood Products Facility, Fort Bragg, California. Prepared for Georgia-Pacific LLC. July.
- Arcadis. 2015b. Baseline Human Health and Ecological Risk Assessment – Operable Unit E, Former Georgia-Pacific Wood Products Facility, Fort Bragg, California. Prepared for Georgia-Pacific LLC. August.
- Arcadis. 2016. Removal Action Work Plan Operable Unit E, Former Georgia-Pacific Wood Products Facility, Fort Bragg, California. Prepared for Georgia-Pacific LLC. May.
- Arcadis BBL. 2007a. Construction Completion Report for Foundation and Ash Pile Removal Projects, Former Georgia-Pacific Wood Products Facility, Fort Bragg, California. Prepared for Georgia-Pacific LLC. April.

- ARCADIS BBL. 2007b. Remedial Investigation Report Operable Unit A Coastal Trail and Parkland Zone. Former Georgia-Pacific Wood Products Facility, Fort Bragg, California. Prepared for Georgia-Pacific, LLC. October.
- ARCADIS BBL. 2007c. Site-Wide Risk Assessment Work Plan. Former Georgia-Pacific Wood Products Facility, Fort Bragg, California. Prepared for Georgia-Pacific, LLC. October.
- ARCADIS BBL. 2007d. Background Metals Report. Former Georgia-Pacific Wood products Facility, Fort Bragg, California. Prepared for Georgia-Pacific, LLC. August.
- ARCADIS BBL. 2007e. Preliminary Site Investigation Work Plan, Operable Unit E – Ponds, Former Georgia-Pacific Wood products Facility, Fort Bragg, California. Prepared for Georgia-Pacific, LLC. December.
- BACE Geotechnical. 2004. Engineering Geologic Reconnaissance Report, Planned Blufftop Access Trail, Georgia-Pacific Property, Fort Bragg, California. Prepared for the City of Fort Bragg. Project No. 11886.1. BACE Geotechnical (a division of Brunsing Associates, Inc.). September.
- BBL. 2006. Current Conditions Report. Former Georgia-Pacific Wood Products Manufacturing Facility, Fort Bragg, California. Prepared for Georgia-Pacific Corporation. Blasland, Bouck & Lee, Inc., an ARCADIS company. December.
- Blackburn Consulting, Inc. 2006. Letter from Mr. Rick Sowers, PE, CEG, Senior Project Manager, and Mr. Tom Blackburn, GE, Principal, to Mr. John Matthey, Acton•Mickelson•Environmental, Inc., re: Geotechnical Evaluation, Bearing Support for Heavy Equipment Loads, Georgia-Pacific Mill Site, Fort Bragg, California. BCI File 924.1. Blackburn Consulting, Inc. February.
- Céspedes, M.A., M.I. Galindo, and J.P. Couso. 2010. Dioxin Toxicity In Vivo Results from an Increase in the Dioxin-Independent Transcriptional Activity of the Aryl Hydrocarbon Receptor. PLoS ONE 5(11): e15382. doi:10.1371/journal.pone.0015382.
- California Department of Water Resources. 1982. Mendocino County Coastal Ground Water Study. June.
- California Coastal Commission (CCC). 2000. Statewide Interpretive Guidelines. Revised June 13, 2000. California Department of Water Resources. 1982. Mendocino County Coastal Ground Water Study. June.
- Collins, J.N., E.D. Stein, M. Sutula, R. Clark, A.E. Fetscher, L. Grenier, C. Grosso and A. Wiskind. 2008. California Rapid Assessment Method (CRAM) for Wetlands, v. 5.0.2. Available online at: <http://www.cramwetlands.org/>.
- Department of Toxic Substances Control (DTSC). 1995. Remedial Action Plan Development and Approval Process. EO-95-007-PP. Available online at: <https://www.dtsc.ca.gov/LawsRegsPolicies/Policies/SiteCleanup/upload/eo-95-007-pp.pdf>. 16 November.

- DTSC. 2009. Remedial Goals for Dioxins and Dioxin-like Compounds for Consideration at California Hazardous Waste Sites. HHRA Note 2. Available online at: [www.dtsc.ca.gov/AssessingRisk/upload/HHRA\\_Note2\\_dioxin.pdf](http://www.dtsc.ca.gov/AssessingRisk/upload/HHRA_Note2_dioxin.pdf).
- DTSC. 2013a. Letter from Mr. Thomas P. Lanphar, Senior Hazardous Scientist, Brownfields and Environmental Restoration Program, to Mr. Dave Massengill, Senior Director, Georgia-Pacific LLC, re: Comprehensive Monitoring Program Update Number 6, Dated November 6, 2013, Former Georgia-Pacific Former Wood Products Facility, Fort Bragg, California. 26 November.
- DTSC. 2013b. Letter from Tom to Dave, Re: Final Remedial Investigation Report – Operable Unit E, Dated January 2013, Former Georgia-Pacific Wood Products Facility, Fort Bragg, California. 7 February.
- DTSC. 2014. Identification of Presumptive Remedy Areas on Operable Unit E Georgia Pacific Former Sawmill Site, Fort Bragg. PCA: 11018. Site Code: 200402-00. 25 June.
- DTSC. 2016. Letter from Mr. Thomas P. Lanphar, Senior Environmental Scientist, Brownfields and Environmental Restoration Program – Berkeley, to Mr. David G. Massengill, Senior Director, Georgia-Pacific LLC, re: Removal Action Work Plan, Operable Unit E, Former Georgia-Pacific Wood Products Facility, Fort Bragg, California. 13 October.
- DTSC. 2017. Letter from Mr. Thomas P. Lanphar, to Mr. David G. Massengill, Senior Director, Georgia-Pacific LLC, re: Well Destruction Workplan, Former Georgia-Pacific Wood Products Facility, Fort Bragg, California. 26 October.
- DTSC. 2018. Letter from Mr. Thomas P. Lanphar, to Mr. David G. Massengill, Senior Director, Georgia-Pacific LLC, re: Final Remedial Action Completion Report for Operable Units C, D, and E, Former Georgia-Pacific Wood Products Facility, Fort Bragg, California. 27 June.
- DTSC. 2019. Letter from Ms. Juliet Pettijohn, to Mr. David G. Massengill, Senior Director, Georgia-Pacific LLC, re: Georgia-Pacific, Operable Unit E Feasibility Study, Former Georgia-Pacific Wood Products Facility, Fort Bragg, California. 24 October.
- DTSC. 2020a. Letter from Ms. Juliet Pettijohn, to Mr. David G. Massengill, Senior Director, Georgia-Pacific LLC, re: Site-Wide Groundwater Operation & Maintenance Plan, Former Georgia-Pacific Wood Products Facility, Fort Bragg, California. 30 March.
- DTSC. 2020b. Letter from Ms. Juliet Pettijohn, to Mr. David G. Massengill, Senior Director, Georgia-Pacific LLC, re: Pond 6, North Pond, and Pond 8 Sediment Sampling Report, Former Georgia-Pacific Wood Products Facility, Fort Bragg, California. 26 May.
- DTSC. 2020c. Email from Mr. Thomas P. Lanphar, to Mr. David G. Massengill, Georgia-Pacific LLC, Jeremie Maehr, Kennedy Jenks, and Rachel Morgan, Kennedy Jenks, re: Former Georgia-Pacific Wood Products Facility / Mendocino Railway - Fort Bragg – Well Destruction Work Plan, by Kennedy Jenks dated June 8, 2020 - GSU comments. 30 June.

- DTSC. 2020d. Email from Mr. Thomas P. Lanphar, to Mr. David G. Massengill, Georgia-Pacific LLC, Jeremie Maehr, Kennedy Jenks, and Rachel Morgan, Kennedy Jenks, re: OUE preliminary draft RAP. 7 October.
- ESA. 2018. Georgia Pacific Mill Site OU-E Mitigation Monitoring, Year 1 Report. December.
- ESA. 2020. Georgia Pacific Mill Site OU-E Mitigation Monitoring, Year 2 Report. January.
- Georgia-Pacific. 1981. Plant Drain System. Drawing No. 4730, Revision 1. Original scale: 1 inch = 100 feet. Georgia-Pacific Corporation. January 27.
- Hahn, M.E. 2002. Aryl Hydrocarbon Receptors: diversity and evolution. *Chemico-Biological Interactions* 141 (2002) 131–160. Available online at: [http://www.who.edu/science/B/people/mhahn/Hahn\\_CBI\\_2002.pdf](http://www.who.edu/science/B/people/mhahn/Hahn_CBI_2002.pdf).
- Hygienetics Environmental Services, Inc. 2003. Asbestos and Lead Based Paint Inspection Report, Georgia Pacific Site, 90 West Redwood Avenue, Fort Bragg, California. February.
- Kennedy Jenks Consultants. 2017. Final OU-C, OU-D, and OU-E Implementation Plan, Former Georgia-Pacific Wood Products Facility, Fort Bragg, California. 14 June.
- Kennedy Jenks Consultants. 2018a. Final Remedial Action Completion Report for Operable Units OU-C, OU-D, and OU-E, Former Georgia-Pacific Wood Products Facility, Fort Bragg, California. 15 June.
- Kennedy Jenks Consultants. 2018b. Wetland Establishment Area Annual Report and As-Built Conditions for Georgia-Pacific Fort Bragg Mill Site. 31 January.
- Kennedy Jenks Consultants. 2019a. Final Feasibility Study Operable Unit E, Former Georgia-Pacific Wood Products Facility, Fort Bragg, California. 12 September.
- Kennedy Jenks Consultants. 2019b. First Semi-Annual 2019 Groundwater Monitoring Report, Former Georgia-Pacific Wood Products Facility, Fort Bragg, California. 21 May.
- Kennedy Jenks Consultants. 2020a. Operable Unit D and Operable Unit E, Groundwater Operation & Maintenance Plan, Former Georgia-Pacific Wood Products Facility, Fort Bragg, California. Prepared for Georgia-Pacific LLC. 23 March.
- Kennedy Jenks Consultants. 2020b. Pond 6, North Pond, and Pond 8 Sediment Sampling Report, Former Georgia-Pacific Wood Products Facility, Fort Bragg, California. 8 April.
- Kennedy Jenks Consultants. 2020c. Well Destruction Work Plan, Former Georgia-Pacific Wood Products Facility, Fort Bragg, California. 8 June.
- Kennedy Jenks Consultants. 2020d. Draft Remedial Action Plan – Operable Unit E, Former Georgia-Pacific Wood Products Facility, Fort Bragg, California. 8 September.

- Mill Site Coordinating Committee. 2012. Mill Site Specific Plan Preliminary. Prepared for Georgia-Pacific Sawmill Facility, Fort Bragg, California. Available online at: <https://city.fortbragg.com/607/Mill-Site-Specific-Plan-2012>. January.
- National Contingency Plan. 2014. 40 CFR 300.430(e)(2)(i)(a)(2) – Remedial Investigation/Feasibility Study and Selection of Remedy. September.
- North Coast Regional Water Quality Control Board. 2011. Water Quality Control Plan for the North Coast Region, Section 3. Water Quality Objectives. Available online at: [http://www.waterboards.ca.gov/northcoast/water\\_issues/programs/basin\\_plan/083105-bp/04\\_water\\_quality\\_objectives.pdf](http://www.waterboards.ca.gov/northcoast/water_issues/programs/basin_plan/083105-bp/04_water_quality_objectives.pdf). 18 March.
- San Francisco Regional Water Quality Control Board (SFRWQCB). 2013. San Francisco Bay Regional Water Quality Control Board Environmental Screening Levels. December. Found online at [http://www.waterboards.ca.gov/rwqcb2/water\\_issues/programs/esl.shtml](http://www.waterboards.ca.gov/rwqcb2/water_issues/programs/esl.shtml)
- TRC. Undated #1. Phase II Determination of Significance Standing Structures Georgia Pacific Lumber Mill Fort Bragg, California. TRC Companies, Inc. Draft Report.
- TRC. Undated #2. Site Specific Treatment Plan for Cultural Resources. TRC Companies, Inc. Draft Report.
- TRC. 1998. Letter from Mr. Mohammad Bazargani, Project Manager, and Dr. Jonathan Scheiner, Senior Project Scientist, to Mr. Larry L. Lake, Environmental Site Coordinator, Georgia-Pacific Corporation, re: Report of Findings, Preliminary Investigation Demolition Support Services, Georgia-Pacific Fort Bragg Facility, Fort Bragg, California. Project No. 97-734. 1 April.
- TRC. 2003. Archaeological Survey of the Georgia Pacific Lumber Mill Fort Bragg, California. TRC Companies, Inc. March.
- TRC. 2004a. Phase I Environmental Site Assessment, Georgia-Pacific California Wood Products Manufacturing Division, 90 West Redwood Avenue, Fort Bragg, California. Prepared for Georgia-Pacific Corporation, 133 Peachtree Street, NE, Atlanta, Georgia. Project No. 41-041901. TRC Companies, Inc. March.
- TRC. 2004b. Phase II Environmental Site Assessment, Georgia-Pacific, 90 West Redwood Avenue, Fort Bragg, California 95437. Prepared for Georgia-Pacific, 133 Peachtree Street, NE, Atlanta, Georgia. Project No. 41-041908. TRC Companies, Inc. 14 May.
- TRC. 2004c. Additional Site Assessment Report, Georgia Pacific Former Sawmill Site, 90 West Redwood Avenue, Fort Bragg, California. Prepared for Georgia-Pacific, 133 Peachtree Street, NE, Atlanta, Georgia. October.
- USEPA. 1988. Guidance for Conducting Remedial Investigations and Feasibility Studies (RI/FS) Under the Federal Comprehensive Environmental Response, Compensation and Liability Act of 1980. Interim Final. Office of Emergency and Remedial Response, U.S. Environmental Protection Agency, Washington, D.C. EPA/540/G-89/004, OSWER Directive 9355.3-01, October.

USEPA. 1990. National Oil and Hazardous Substances Pollution Contingency Plan (NCP). 40 CFR 300 et seq.

West, C.W., G.T. Ankley, J.W. Nichols, G.E. Elonen and D.E. Nessa. 1997. Toxicity and bioaccumulation of 2,3,7,8-tetrachlorodibenzo-p-dioxin in long-term tests with the freshwater benthic invertebrates *Chironomus tentans* and *Lumbriculus variegatus*. *Environ. Toxicol. Chem.* 16:1287-1294.

WRA Environmental Consultants (WRA). 2005. Biological Assessment, Georgia Pacific Fort Bragg Sawmill Factory, Fort Bragg, Mendocino County, California. Prepared for Georgia Pacific, Atlanta, Georgia. WRA Environmental Consultants, Inc. November. Species lists updated 2007.

WRA. 2009. Delineation of Potential Section 404 Jurisdictional Wetlands and Waters, Former Georgia-Pacific Wood Products Facility, Fort Bragg, Mendocino County, California. September.

## Tables

---



Table 2-1: Area of Interest Status and Proposed Remedial Action

AOI	AOC (a)	OU	Media	NFA in RI Report	NFA in RACR	Proposed Remedial Action in Approved OU-E FS
Water Treatment and Truck Dump (b)	--	E	--		X	NFA
Sawmill #1 (b)	--	E	--		X	NFA
Compressor House and Lath Building (b)	--	E	--		X	NFA
Powerhouse and Fuel Barn (b)	--	E	--		X	NFA
Pond 8 Fill Area	--	E	--	X		NFA
Ponds 5 and 9	--	E	--			NFA
Riparian	--	E	--		X	NFA
Pond 8	Pond 8	E	Sediment			LUC and SMP, Mill Pond Dam Modification and Beach Berm O&M
Pond 6 and North Pond	North Pond and Pond 6	E	Sediment			LUC and SMP, Beach Berm O&M
Pond 7	Pond 7	E	Sediment			LUC and SMP, Beach Berm O&M
Southern Ponds	Southern Ponds	E	Sediment			LUC and SMP
West IRM	OU-E Groundwater	E	Groundwater			LUC and MNA
IRM		E	Groundwater			LUC and MNA

**Notes:**

(a) AOIs evaluated in the OU-E FS became AOCs.

(b) This AOI was collectively evaluated as part of the OU-E Lowland Terrestrial Soil AOI.

-- = Not Applicable

AOI = Area of Interest

AOC = Area of Concern

OU = Operable Unit

RI = Remedial Investigation

BHHERA = Baseline Human Health and Ecological Risk Assessment

RACR = Remedial Action Completion Report

NFA = No Further Action

RAP = Remedial Action Plan

LUC = land use controls

SMP = Soil Management Plan

O&M = operation and maintenance

MNA = monitored natural attenuation

Table 2-2: Exposure Point Concentrations for COCs in  
Each AOI with Proposed Remedial Action  
Summary of Risk Drivers for Soil in OU-E

Dataset	Dioxin TEQ pg/g	Arsenic mg/kg
<b>Proposed Remedial Goal</b>	<b>53</b>	<b>10</b>
Pond 8 AOC	107	9.7
Pond 6, Pond 7, and North Pond	109	25
Southern Ponds AOC	263 (0 - 0.5 ft bgs) 150 (0 - 2 ft bgs)	50 (0 - 0.5 ft bgs) 41 (0 - 2 ft bgs)

**Notes:**

ft bgs = feet below ground surface

mg/kg = milligrams per kilogram

pg/g = picograms per gram

AOC = area of concern

AOI = area of interest

EPC = exposure point concentration

COC = contaminant of concern

TEQ = toxic equivalent

BHHERA = Baseline Human Health and Ecological Risk Assessment

RACR = Remedial Action Completion Report

(a) EPCs were presented in the BHHERA. EPCs for Pond 7 and Southern Ponds were updated in the RACR (Kennedy Jenks 2018). EPCs for Pond 8 and a combined Pond 6, Pond 7, and North Pond dataset were calculated in the Pond 6, North Pond, and Pond 8 Sediment Sampling Report (Kennedy Jenks 2020b). Presented EPCs were calculated using all available data (i.e., all depth intervals) unless otherwise stated.

Table 3-1: Applicable or Relevant and Appropriate Requirements (ARARs) and "To be Considered" (TBC) Factors

Standard, Requirement, Criteria, Limitation	Citation	Description	Type of ARARs
<b>Federal</b>			
Clean Air Act	42 USC 7401-7642	Emission standards from stationary and mobile sources	Chemical
Clean Water Act	33 USCA 1251-1376 40 CFR 100-149	Regulations requiring development and implementation of a storm water pollution prevention plan	Action
National Archaeological and Historical Preservation Action	16 USC 469 36 CFR 65	Provides requirements if significant scientific/cultural/historical artifacts are found	TBC
Occupational Health and Safety	29 CFR 1910.120	Establishes requirements for health and safety training	Action
Regional Screening Levels	USEPA Region 9, 2015	Risk-based concentrations that are intended to assist risk assessors and others in initial screening-level evaluations of environmental measurements	TBC
Resource Conservation and Recovery Act (RCRA)	42 USC 6901 et. seq. 40 CFR 258	Establishes criteria for generation, management, and disposal of non-hazardous solid waste	Chemical/ Action
	42 USC 6901 et. seq. 40 CFR 261	Establishes criteria to determine whether solid waste exhibits characteristics that makes it a regulated hazardous waste	Chemical/ Action
	42 USC 6901 et. seq. 40 CFR 263	Standards applicable to transporters of hazardous waste	Chemical/ Action
Risk Assessment Guidance for Superfund; Ecological Risk Assessment Guidance for Superfund; Ecological Soil Screening Levels	USEPA, 1989, 1997, 2010	Guidance and framework to assess human and ecological risks	TBC
Toxic Substances Control Act	40 CFR 761.60, 761.61, 761.75	Regulations that determine the appropriate characterization, cleanup, and disposal requirements for PCBs	Chemical/ Action
<b>State and Local</b>			
Ambient Air Quality Standards	HSC 39000-44071 MCAQMD Regulations 1-5	Establishes standards for emissions of chemical vapors and dust	Chemical
California Coastal Act	Public Resources Code Division 20	Establishes permitting requirements and conditions for any "development" which remedial activities qualify as.	Location/ Action
California Environmental Quality Act	PRC Division 13	Mandates environmental impact review of projects approved by governmental agencies	Action
California Hazardous Substances Account Act	HSC 25300-25395.15	Establishes site mitigation and cost recovery programs	Action
California Hazardous Waste Control	HSC 5100-25250.26	Establishes hazardous waste control measures	Action
California Department of Toxic Substances Control Screening Levels	Department of Toxic Substances Control, Human Health Risk Assessment Note 3, DTSC-modified Screening Levels, April 2019	Modified screening levels based on the U.S. Environmental Protection Agency (USEPA) Regional Screening Levels (RSLs) for use in the human health risk assessment process at hazardous waste sites and permitted facilities	Chemical
City of Fort Bragg Grading Permit Requirements and Procedures	Title 18, Chapter 18.60 et. seq.	Establishes requirements for excavation and grading	Location/ Action
City of Fort Bragg, Coastal General Plan Policy	Open Space Element	Includes several policies addressing development in Environmental Sensitive Habitat Areas (ESHA), rivers, streams, riparian habitat, public access, water quality	Location
City of Fort Bragg, Coastal General Plan Policy	Safety Element	Includes several policies addressing safe development within coastal zone, including along bluff and beaches	Location
City of Fort Bragg, Coastal General Plan Policy	Community Design Element	Includes several policies addressing design issues like views, scenic areas, alteration of landforms	Location
Cover, grading, and alternative design requirements	27 CCR 21090(a)(1) through (3) and (b)(1)	Establishes criteria for cover and grading. Alternative cover designs are also acceptable.	Action
Discharges of Hazardous Waste to Land	Title 23, California Code of Regulations, Division 3, Chapter 15	Applies to discharge of waste	Action
Emission Standard	MCAQMD Regulation 1 Chapters 1, 2 and 4	Establishes emission standards and permitting requirements for equipment and dust	Action
Identification and listing of hazardous waste	HSC 25100 et. seq. 22 CCR 66261	Establishes criteria for characterization and classification of remediation waste.	Chemical/Action
Manifest System, Record-Keeping, Reporting and Transportation of Hazardous Waste	22 CCR Chapter 13	Governs transportation of hazardous materials	Action
Occupational Health and Safety	8 CCR GISO 5192	Establishes worker health and safety requirements	Action
Porter-Cologne Water Quality Control Act	California Water Code, Section 13000	Establishes policy for preservation and enhancement of the beneficial uses of the waters of the state	SWRCB
Relevant Policies for the Protection and Conservation of Fish and Wildlife	California Fish and Game Code Section 2014	Requires conservation of natural resources and prevention of the willful or negligent destruction of birds, mammals, fish, reptiles, or amphibia.	Location/ Action
	California Fish and Game Code Section 1600	Establishes protection and conservation of the fish and wildlife resources.	Location/ Action
Remedial Action Plan Policy	EO-95-007-PP	Guidance and framework to develop a remedial action plan	TBC

Table 3-1: Applicable or Relevant and Appropriate Requirements (ARARs) and "To be Considered" (TBC) Factors

Standard, Requirement, Criteria, Limitation	Citation	Description	Type of ARARs
Requirements for Substances Deleterious to Fish and Wildlife	California Fish and Game Code Section 5650	Makes it unlawful to deposit into, permit to pass into, or place where it can pass into the waters of the state certain specified pollutants.	Chemical/ Action
Site Investigation and Remediation Order	Docket No. HSA-RAO 06-07-150	Establishes requirements for investigation and site remediation	Action
State PCB Requirements	22 CCR 66261.113	Establishes standards to disposal of PCBs	Chemical/ Action
State Water Resources Control Board (SWRCB) Resolution No. 68-16	SWRCB, 1968	Establishes policy for the regulation of discharges to waters of the state.	TBC
SWRCB Resolution No. 92-49	SWRCB, 1996 California Water Code Section 13304	Establishes policies and procedures for investigation and cleanup and abatement of discharges.	TBC
Stockpiling Requirements of Contaminated Soil	HSC 25123.3(a)(20)	Establishes standards for stockpiling of non-RCRA contaminated soil	Location/ Action
Supplemental Guidance for Human Health Multimedia Risk Assessments of Hazardous Waste Sites and Permitted Facilities; Guidance for Ecological Risk Assessment at Hazardous Waste Sites and Permitted Facilities	DTSC, 1996 CalEPA, 2015	Guidance and framework to assess human and ecological risks	TBC
Title 22, California Hazardous Waste Control Act of 1972	22 CCR 66260.1 et seq.	Establishes criteria for determining waste classification for the purposes of transportation and disposal of wastes	Chemical/ Action
	22 CCR 66262.1 et seq.	Establishes standards applicable to generators of hazardous waste	Action
	22 CCR Chapter 18	Identifies hazardous waste restricted from land disposal unless specific treatment standards are met	Chemical/ Action
Title 27, Division 2 of the California Code of Regulations	27 CCR 20005 et seq.	Regulation of solid waste	Chemical/ Action
Water Quality Control Plan for the North Coast Region	Basin Plan, June 2018	The North Coast Basin Plan is designed to provide a definitive program of actions to preserve and enhance water quality and protect beneficial uses of all regional waters.	Action/ Chemical/ Location
Water Quality Control Plan for Ocean Waters of California (California Ocean Plan), 2012, Effective August 19, 2013	State Water Resources Control Board Resolutions Nos. 2012-0056; 2012-0057	Addresses degradation of marine communities or other exceedances of water quality objectives due to waste discharges.	Action/ Chemical/ Location
Ocean Protection Council Sea Level Rise Guidance	State of California Sea-Level Rise Guidance, 2018 Update	The Guidance provides: 1) a synthesis of the best available science on sea-level rise projections and rates for California; 2) a stepwise approach for state agencies and local governments to evaluate those projections and related hazard information in decision-making; and 3) preferred coastal adaptation approaches." Most current version of guidance will be considered when permit applications are prepared.	TBC
Native American Consultation and Cultural Protection	California Public Resources Code Section 21080.3.1	Requires that lead agency consult with Native American tribe that is traditionally and culturally affiliated with the geographical area prior to release of negative declaration or environmental impact report for a project.	Location

**Notes:**

ARAR - Applicable or Relevant and Appropriate Requirement  
 CalEPA - California Environmental Protection Agency  
 CCR – California Code of Regulation  
 CFR – Code of Federal Regulation  
 CHHSLs - California Human Health Screening Levels  
 DTSC - Department of Toxic Substances Control  
 GISO - General Industry Safety Order  
 HSC - Health and Safety Code  
 MCAQMD – Mendocino County Air Quality Management District

NCRWQCB - North Coast Regional Water Quality Control Board  
 PCB - polychlorinated biphenyl  
 PRC - Public Resource Code  
 RCRA - Resource Conservation and Recovery Act  
 SWRCB – State Water Resources Control Board  
 TBC - to be considered  
 USC – United States Code  
 USCA – United States Code Annotated  
 USEPA - United States Environmental Protection Agency

**References:**

DTSC. 1996. *Supplemental Guidance for Human Health Multimedia Risk Assessments of Hazardous Waste Sites and Permitted Facilities*. State of California Environmental Protection Agency, Office of Scientific Affairs. August.  
 DTSC. 2019. *Human Health Risk Assessment (HHRA) Note 3, DTSC-modified Screening Levels (DTSC-SLs)*. April.  
 CalEPA. 2015. *Public Health Goals for Drinking Water*. Office of Environmental Health Hazard Assessment. Available online at: <http://www.oehha.ca.gov/water/phg/index.html>. February.  
 City of Fort Bragg. 2008. *Coastal General Plan*. July. <https://city.fortbragg.com/284/Coastal-General-Plan>  
 NCRWQCB. 2018. *Water Quality Plan for the North Coast Region*. Available online at: [https://www.waterboards.ca.gov/northcoast/water\\_issues/programs/basin\\_plan/basin\\_plan\\_documents/](https://www.waterboards.ca.gov/northcoast/water_issues/programs/basin_plan/basin_plan_documents/). June.  
 SWRCB. 1968. *Resolution No. 68-16, Statement of Policy with Respect to Maintaining High Quality of Waters in California*. Available online at: [http://www.waterboards.ca.gov/board\\_decisions/adopted\\_orders/resolutions/1968/rs68\\_016.pdf](http://www.waterboards.ca.gov/board_decisions/adopted_orders/resolutions/1968/rs68_016.pdf). October 28.  
 SWRCB. 1996. *Resolution No. 92-49, Policies and Procedures for Investigation and Cleanup and Abatement of Discharges under Water Code Section 13304*. Available online at: [http://www.waterboards.ca.gov/water\\_issues/programs/land\\_disposal/resolution\\_92\\_49.shtml](http://www.waterboards.ca.gov/water_issues/programs/land_disposal/resolution_92_49.shtml). October 2.  
 USEPA. 1989. *Risk Assessment Guidance for Superfund*. Office of Emergency and Remedial Response. EPA/540/1-89/002. Available online at: <http://www.epa.gov/oswer/riskassessment/ragosa/>. December.  
 USEPA. 1997. *Ecological Risk Assessment Guidance for Superfund: Process for Designing and Conducting Ecological Risk Assessments*. Office of Emergency and Remedial Response. EPA 540-R-97-006. Available online at: <http://www.epa.gov/oswer/riskassessment/ecorisk/ecorisk.htm>. June.  
 USEPA. 2010. *Ecological Soil Screening Levels*. Available online at: <http://www.epa.gov/ecotox/ecossl/index.html>. October.  
 USEPA, Region 9. 2015. *Regional Screening Levels (Formerly PRGs)*. Available online at: <http://www.epa.gov/region9/superfund/prg/>. June.  
 California Ocean Protection Council (OPC) and California Natural Resources Agency. 2018. *State of California Sea Level Rise Guidance, 2018 Update*. [http://www.opc.ca.gov/webmaster/ftp/pdf/faqenda\\_items/20180314/Item3 Exhibit-A OPCSLR Guidance-rd3.pdf](http://www.opc.ca.gov/webmaster/ftp/pdf/faqenda_items/20180314/Item3 Exhibit-A OPCSLR Guidance-rd3.pdf)  
 California Coastal Commission (CCC). 2018. *Sea Level Rise Policy Guidance*. July. [https://documents.coastal.ca.gov/assets/climate/2018ScienceUpdate\\_website\\_7.20.18.pdf](https://documents.coastal.ca.gov/assets/climate/2018ScienceUpdate_website_7.20.18.pdf)

Table 3-2: OU-E Draft Site-Specific Cleanup Goals for Sediment, Soil, and Groundwater

COC	Media	Units	Proposed Site-Specific Cleanup Goal	Basis for Goal
Arsenic	Sediment and Soil	mg/kg	10	Site-specific Background Concentrations
Dioxin TEQ <sup>(a)</sup>	Sediment and Soil	pg/g	50	Residential Cleanup Goal <sup>(b)</sup>
Barium	Groundwater <sup>(c)</sup>	µg/L	1,000	CA Primary MCL
Total Gasoline (C6-C10)	Groundwater <sup>(c)</sup>	µg/L	50	T&O Threshold
Total Diesel (C10-C24)	Groundwater <sup>(c)</sup>	µg/L	100	T&O Threshold

**Notes:**

- (a) The Dioxin TEQ human health RBTL, as defined in the OU-E RAW, is protective of the BHHERA occasional recreator.
- (b) The recreational goal is 53 pg/g. Human Health RBTLs and Ecological RBTLs are further described in the OU-E RAW.
- (c) The draft site-specific groundwater cleanup goals are for unrestricted land use. Some alternatives presented in this Feasibility Study propose Institutional Controls to limit land use, and therefore, these draft cleanup goals may not be appropriate for all alternatives.

CA Primary MCL = California Department of Public Health Primary MCL  
 CVWQCB T&O = CVRWQCB (2004) TPH water quality objectives for taste and odor  
 MCL = Maximum Contaminant Level  
 T&O = taste and odor  
 µg/L = micrograms per liter = parts per billion  
 mg/kg = milligrams per kilogram = parts per million  
 pg/g = picograms per gram = parts per trillion

Table 4-1: Preliminary and Detailed Screening of Process Options Screening - Soil

General Response Action	Remedial Technology	Process Option	Description	Effectiveness Evaluation	Implementability Evaluation	Relative Cost Evaluation	Retained?	Decision Rationale			
No Action	No Action	No Action	No remedial action	---	---	---	Yes	Required by NCP and USEPA guidance as baseline for comparison to other process options.			
Institutional Controls	Institutional Controls	Land Use Controls	Institutional controls include a variety of measures designed to restrict current and future property owners from taking actions that would expose potential receptors to unacceptable risk, interfere with effectiveness of the final remedial action, and/or convert the site to an end use that is not consistent with the level of remediation. The primary objective of institutional controls is to limit potential for exposure to COIs by restricting access to impacted areas.	Moderate	Standard practice for protecting human health and the environment, effectiveness governed by maintenance of institutional controls.	High	Easily implemented	Low	Low capital and O&M costs.	Yes	Institutional controls impose restrictions on land use. LUCs provide protection of human health and the environment by restricting land use until constituent concentrations in soil meet the requirements for unrestricted use.
Containment	Covers	Vegetative Cover	A vegetative cover restricts exposure pathways of potential receptors to affected media.	Moderate	Covers are an effective means of restricting exposure and allow natural attenuation to occur.	High	Readily implementable.	Moderate	Low capital and O&M costs.	Yes	Conventional technology; can be used in conjunction with other technologies.
In-Situ Treatment	Physical	Soil Mixing	In-situ soil mixing encapsulates contaminants in solidified media by in-situ mixing of impacted soil with solidifying reagents (e.g., cement, bentonite). This process option does not destroy COIs, but incorporates them into a dense, homogeneous, low-permeability structure that reduces concentrations and mobility	Moderate - High	Provides effective mitigation of risks to receptors.	Moderate - Low	Applicable to all constituents	Moderate - High	High capital costs.	Yes	ISM provides effective mitigation of risks to receptors, and is applicable to all COIs within each AOC.
		Soil Vapor Extraction	Utilizes induced vacuum in the vadose zone to capture volatiles in the subsurface.	Low - Moderate	Variability of constituents triggering exceedances within each area, SVE, MPE, and thermal will not be effective at remediating most COIs present in OU-E.	Moderate - High	Implementation of extraction is limited to constituent with sufficient volatility to be removed in the vapor phase.	Moderate to high	Capital cost associated with treatment system installation is expensive per level of effectiveness on a comparative basis.	No	The capital cost associated with treatment system installation is too expensive per level of effectiveness on a comparative basis to be considered for partial implementation
		Multiphase Extraction								No	
	Thermal	No									
	Biological	Mycoremediation	Uses fungi such as mushrooms to potentially remove, transfer, stabilize, and destroy COIs in soil.	Low		Low	Mycoremediation within OU-E is not feasible throughout the full depth of affected soil. Further, Mycoremediation was not shown to be effective in previous studies.	Moderate	Cost to apply Mycoremediation would be high relative to other options based on the low treatment effectiveness measured in the previous studies.	No	A total of 30 fungal strains were evaluated for growth potential using site soils and sediments; nine of these fungal strains were collected from the site. The 10 strains that showed the greatest growth potential in site soils and sediments were selected for the dioxin/furan degradation phase of the study. Comparison of analytical results for spiked samples containing fungi to spiked control samples not containing fungi found no discernable degradation of dioxins/furans after incubation.
Chemical	Chemical Oxidation	Chemical oxidation involves mixing additives (such as sodium persulfate) in-situ to induce reduction/oxidation reactions that chemically convert hazardous contaminants to non-hazardous or less toxic compounds that are more stable or inert.	Low	Effective on small portion of constituents in soil and effectiveness must be evaluated by treatability test or bench scale study. Would generate secondary effects that degrade soil and groundwater quality.	Low - Moderate	Implementation for a small portions of areas of concern	Moderate - High	High implementation costs.	No	Considering implementability concerns and the potential for generation of byproducts.	
Ex-Situ Treatment	Physical	Landfarming	Process option that consists of spreading the excavated soils in windrows to stimulate aerobic microbial activity through aeration and/or the addition of minerals, nutrients, and moisture to expedite treatment.	Moderate	Effective for reduction of volatile COIs. Ineffective for metals and dioxin.	Moderate - High	Readily implementable and effective for reduction of volatile constituents. Site disturbance is high as soil needs to be spread to be effective.	High	Excavation and land farming costs can be similar to excavation and disposal depending on the timeframe required for COIs to degrade.	Yes	Land farming may be similar in cost to offsite disposal, but is only effective for a limited number of COIs.
		Biopiling	Involves heaping impacted excavated soils into aboveground storage cells and stimulating aerobic microbial activity via aeration and/or addition of minerals, nutrients, and moisture.	Moderate	Requires bench-scale study and/or a pilot test prior to the determination of site-specific effectiveness.	Moderate-high	Implementable with similar space and site disturbance issues as landfarming.	High	High capital and O&M costs.	No	Uncertain and comparative moderate to high costs compared to other ex-situ treatment/disposal methods.
Removal	Excavation & Disposal	Excavation & Disposal	Physical removal of impacted soil with offsite landfill disposal.	High	Immediately effective	Moderate - High	Readily implementable and effective for reduction of all constituents.	High	High capital and O&M costs.	Yes	Excavation is technically implementable and would provide immediate and permanent removal of COIs from the site.

**Notes:**  
 Green shading indicates that the process option will be further evaluated as a stand-alone alternative.  
 Yellow shading indicates that the process option will be partially incorporated into the development of action-based alternatives.  
 Red shading indicates that the process option was eliminated in the preliminary screening stage.

**Acronyms:**  
 COI - chemical of interest  
 DGR - directed groundwater recirculation  
 ISB - in-situ bioremediation

LUC - land use control  
 NCP - National Contingency Plan  
 O&M - operation and maintenance  
 SVE - soil vapor extraction

USEPA - United States Environmental Protection Agency  
 VAFB - Vandenberg Air Force Base  
 VOC(s) - volatile organic compounds

Table 4-2: Preliminary and Detailed Screening of Process Options - Sediment

General Response Action	Remedial Technology	Process Option	Description	Effectiveness Evaluation	Implementability Evaluation	Relative Cost Evaluation	Retained?	Decision Rationale
No Action	No Action	No Action	No remedial action	---	---	---	Yes	Required by NCP and USEPA guidance as baseline for comparison to other process options.
Institutional Controls	Institutional Controls	Land Use Controls	Institutional controls include a variety of measures designed to restrict current and future property owners from taking actions that would expose potential receptors to unacceptable risk, interfere with effectiveness of the final remedial action, and/or convert the site to an end use that is not consistent with the level of remediation. The primary objective of institutional controls is to limit potential for exposure to COIs by restricting access to impacted areas. The Mill Pond Dam and beach berm would continue to provide sediment containment.	Moderate Standard practice for protecting human health and the environment, effectiveness governed by maintenance of institutional controls.	High Easily implemented	Low Low capital and O&M costs.	Yes	Institutional controls impose restrictions on land use. LUCs provide protection of human health and the environment by restricting land use until constituent concentrations in sediment meet the requirements for unrestricted use.
Containment	Covers	Vegetative Cover	A vegetative cover prevents exposure pathways of potential receptors to affected media. The Mill Pond Dam and beach berm would continue to provide sediment containment.	Moderate A vegetative cover restricts exposure pathways of potential receptors to affected media. Covers installed in aquatic environments with variable storm water flow may be eroded over time.	Moderate - Low Covers are an effective means of restricting exposure, however placement of covers on geotechnically weak sediments is difficult.	High Capital cost to install caps over sediment can require sediment stabilization, drainage, or other costs of performing work "in the wet". O&M costs may be high as erosion of caps in dynamic environments may require repair or replacement periodically.	Yes	A cover would effectively restrict the potential risk to receptors in accordance with RAOs until cleanup goals are achieved.
In-Situ Treatment	Physical	Soil Mixing	ISM technology can be used to immobilize organic and inorganic compounds in saturated sediments, using reagents to produce an inert, geotechnically strong, and relatively less permeable material, such as Portland cement. The Mill Pond Dam and beach berm would continue to provide sediment containment.	High Incorporates COIs into a dense, homogeneous, low-permeability structure that reduces concentrations and mobility.	Moderate - Low In-situ mixing can be performed with an excavator bucket or a large diameter crane-mounted auger depending on depth and volume. Work in aquatic environments would destroy habitat and would require significant mitigation.	High Implementation cost is high to treat wet sediment.	Yes	ISM requires significant volumes of binders and Portland cement to be effective and would require mitigation of habitat loss, but would effectively restrict exposure to COIs.
	Biological	Mycoremediation	Uses fungi such as mushrooms to potentially remove, transfer, stabilize, and destroy COIs in sediment. The Mill Pond Dam and beach berm would continue to provide sediment containment during treatment.	Low A laboratory study of mycoremediation was prepared by NewFields for use of mushrooms and fungi to remediate dioxins and furans at the Site (NewFields, 2011). The primary objective of this study was to evaluate the potential for various strains of fungi to degrade dioxins/furans in site soils to evaluate whether mycoremediation could be an effective remedial process option at the site. Mycoremediation was not effective during the study.	Low Mycoremediation within the Pond AOIs with impacts to sediment is not feasible as the sediments are typically submerged. Further, Mycoremediation was not shown to be effective in previous studies.	High Contact with sediment would require removal from the aquatic environment at high implementation cost.	No	A total of 30 fungal strains were evaluated for growth potential using site soils and sediments; nine of these fungal strains were collected from the site. The 10 strains that showed the greatest growth potential in site soils and sediments were selected for the dioxin/furan degradation phase of the study. Comparison of analytical results for spiked samples containing fungi to spiked control samples not containing fungi found no discernable degradation of dioxins/furans after incubation.
		Biological Oxidation	Involves injection of substrates into the target media to promote biological degradation of target COCs. The Mill Pond Dam and beach berm would continue to provide sediment containment during treatment.	Low Achieving significant distribution of reagents is likely not feasible within fine-grained matrices characteristic of the sediments at the site. Biological Oxidation would not be effective for all COIs.	Low Well installation or direct push injection activities to deliver reagents will be restricted for sediments located in pond areas.	High High implementation cost	No	Based on effectiveness and implementability considerations.
	Chemical	Chemical Oxidation	Chemical oxidation involves mixing additives (such as sodium persulfate) in-situ to induce reduction/oxidation reactions that chemically convert hazardous contaminants to non-hazardous or less toxic compounds that are more stable or inert. The Mill Pond Dam and beach berm would continue to provide sediment containment during treatment.	Low Achieving significant distribution of reagents is likely not feasible within fine-grained matrices characteristic of the sediments at the site. Chemical Oxidation would not be effective for all COIs.	Low Injecting oxidizing chemicals in sediment would be harmful to the existing biota and would not be permissible.	High High implementation cost	No	Injecting oxidizing reagents in pond sediment would not be an acceptable discharge to waters of the State and US and would not be permissible.
Ex-Situ Treatment	Physical	Landfarming	Physical removal and tilling of impacted sediment. Affected sediment is periodically turned over to re-aerate. Amendments may be added to aid the composting processes.	Low The nature of COIs driving risk within the sediment AOIs, biological treatment will not be sufficient to reduce COI concentrations to meet target cleanup goals and achieve RAOs.	Moderate - High Can be readily implemented for sediment	Moderate Moderate capital and high O&M cost	No	Landfarming and biopiling both rely upon biological treatment of COIs to achieve effective mass reduction. Based on the nature of COIs driving risk within the sediment AOIs, biological treatment will not be sufficient to reduce COI concentrations to meet target cleanup goals and achieve RAOs.
Biopiling								
Removal	Excavation & Disposal	Excavation & Disposal	Physical removal of impacted sediment with offsite landfill disposal.	High Immediately effective and readily implementable.	Moderate - High Readily implementable.	High Moderate - high capital cost and low O&M cost.	Yes	Excavation is technically implementable and would provide immediate and permanent removal of COIs from the site.

**Notes:**  
Green shading indicates that the process option will be further evaluated as a stand-alone alternative.  
Red shading indicates that the process option was eliminated in the preliminary screening stage.

**Acronyms:**  
COI - chemical of interest  
DGR - directed groundwater recirculation  
ISB - in-situ bioremediation  
LUC - land use control  
NCP - National Contingency Plan  
O&M - operation and maintenance  
RAO - Remedial Action Objective  
SVE - soil vapor extraction  
USEPA - United States Environmental Protection Agency  
VAFB - Vandenberg Air Force Base  
VOC - volatile organic chemical  
VOCs - volatile organic compounds

Table 4-3: Preliminary and Detailed Screening of Process Options - Groundwater

General Response Action	Remedial Technology	Process Option	Description	Effectiveness Evaluation	Implementability Evaluation	Relative Cost Evaluation	Retained?	Decision Rationale			
No Action	No Action	No Action	No remedial action	---	---	---	Yes	Required by NCP and USEPA guidance as baseline for comparison to other process options.			
Institutional Controls	Institutional Controls	Land Use Controls	Institutional controls are administrative actions that minimize exposure by limiting land or resource use; institutional controls maintain protectiveness by modifying or guiding human behavior.	Moderate	Standard practice for protecting human health and the environment, effectiveness governed by maintenance of institutional controls.	Moderate - High	Generally implementable but requires close coordination of regulatory authorities.	Low	Low capital and O&M costs.	Yes	Standard practice for management of former industrial sites.
Monitored Natural Attenuation	Monitored Natural Attenuation	Monitored Natural Attenuation	Monitoring events are performed to confirm that COI concentrations are attenuating over time via natural subsurface processes.	Moderate	Natural attenuation processes is effective for reduction of COIs.	High	Readily implementable.	Low	Low capital and O&M costs; existing infrastructure can be used for groundwater monitoring.	Yes	Conventional technology; can be used in conjunction with other technologies.
Containment	Barrier	Diversion Barrier	Installation of an impermeable containment barrier downgradient of COI-impacted soil/groundwater extending through the water table to COI prevent mobility.	Moderate - High	Effective for restricting movement of COIs.	Moderate	May require specialized equipment to construct slurry walls or sheet pile walls. May not be implementable in wetland areas.	Moderate	High capital cost for barrier installation	No	COIs migration is already limited at the site and implementation may be difficult in the OU-E lowland.
In-Situ Treatment	Physical	Air Sparge/Soil Vapor Extraction	Injection of air below the groundwater table to physically strip volatile COIs from groundwater. Air sparging also has a limited ability to increase background oxygen concentrations and promotes aerobic biodegradation processes.	Moderate	Low volatility of diesel phase COCs may limit effectiveness.	Moderate - High	Is readily implementable for fuel constituents in groundwater in the IRM and West of IRM AOIs	Low	High capital and O&M costs.	Yes	Due to the low volatility of diesel phase petroleum hydrocarbon COCs, AS/SVE is unlikely to provide meaningful removal of residual diesel fuel mass
		Thermal	Thermal remediation relies upon heating groundwater using a variety of technologies to enhance volatilization of constituents and capturing COIs with SVE	Moderate - High	Effective for mass removal in groundwater	Moderate - High	Is readily implementable for fuel constituents in groundwater in the IRM and West of IRM AOIs	High	Significant capital and O&M costs for implementation	No	Capital and O&M cost and thermal remediation poses several health and safety and permitting concerns for implementation.
	Biological	Enhanced Aerobic Bioremediation	The injection of a substrate (such as calcium peroxide) to stimulate native microorganisms and degrade COIs via the addition of oxygen as an electron acceptor.	Moderate - High	Effective and implementable for remediation of VOCs and other fuel-related constituents.	Moderate - High	Effective and implementable for remediation of VOCs and other fuel-related constituents.	Moderate	Moderate capital and O&M costs	Yes	Effective for TPH constituents in IRM and West of IRM AOI.
		Enhanced Anaerobic Bioremediation	The injection of a substrate (such as magnesium sulfide) to stimulate native microorganisms and degrade COIs via the addition of an electron acceptor in a low-oxygen or oxygen-free environment.					Moderate	Moderate capital and O&M costs	Yes	Effective for TPH constituents in IRM and West of IRM AOI.
		Phytoremediation	Uses plants to potentially remove, transfer, stabilize, and destroy COIs in shallow groundwater.	Moderate	Effectiveness of phytoremediation at the site is unknown, and would require treatability studies to establish remedial timeframes.	Moderate	The average depth of groundwater near the OU-E Groundwater AOC, a tree/shrub plantation with roots extending 10 to 15 feet bgs would likely be the main application for treatment.	Low	Low capital and O&M costs.	No	The effectiveness of phytoremediation at the site is unknown, and would require treatability studies to establish remedial timeframes. Not retained given the uncertainty associated with the remedial approach in achieving RAOs.
	Chemical	Chemical Oxidation	Use of chemical oxidant (ozone, hydrogen peroxide, persulfate, or permanganate) to oxidize COIs in-situ.	Moderate	ISCO is an established technology that can be effective for petroleum constituents.	Moderate - High	Redox reactions can generate byproducts that impact water quality.	Moderate	Moderate capital and O&M costs	No	Based on the relatively low concentrations of residual petroleum hydrocarbons, ISCO reactions are likely to result in more severe secondary water quality affects than current COCs in groundwater.
		Permeable Reactive Barrier	Consists of a subsurface emplacement of reactive materials (zero valent iron) built below ground to intercept and treat COI-affected groundwater. A PRB is built by excavating a narrow trench perpendicular to the path of the COIs in groundwater.	Low	Effectiveness is tied to groundwater flushing across the AOC and reactivity with the barrier materials.	Low	Challenging to implement in the site setting at OU-E	Moderate	High capital and O&M cost	No	Based on effectiveness and implementability considerations.
	Ex-Situ Treatment	Groundwater Extraction & Treatment	Pump & Treat (reinjection)	COIs in extracted groundwater are removed through a series of process methods including physical, chemical, or biological treatment, such as granular activated carbon and air stripping. Treated groundwater is reinjected into groundwater table.	High	Technology is proven to be effective.	High	Feasible at site	High	High capital and O&M costs.	No
Pump & Treat (disposal)			COIs in extracted groundwater are removed through a series of process methods including physical, chemical, or biological treatment, such as granular activated carbon and air stripping.	High	Technology is proven to be effective.	High	Feasible at site	High	High capital and O&M cost	Yes	Based on current and anticipated site conditions and relatively low concentrations, low mass removal is not likely to result in measurable changes in site conditions.

**Notes:**  
Green shading indicates that the process option will be further evaluated as a stand-alone alternative.  
Red shading indicates that the process option was eliminated in the preliminary screening stage.

**Acronyms:**  
COI - chemical of interest  
DGR - directed groundwater recirculation  
ISB - in-situ bioremediation  
LUC - land use control  
NCP - National Contingency Plan  
O&M - operation and maintenance  
SVE - soil vapor extraction  
USEPA - United States Environmental Protection Agency  
VAFB - Vandenberg Air Force Base  
VOC - volatile organic chemical



Table 4-4: Comparison of Remedial Alternatives

Media	AOC	Risk Summary	Alternative	Description	Threshold (Yes or No) Criteria		Balancing (Low, Moderate, or High) Criteria				
					Overall Protection of Human Health and the Environment	Compliance with ARARs	Long Term Effectiveness and Permanence	Reduction of Toxicity, Mobility, or Volume Through Treatment	Short Term Effectiveness	Implementability	Cost
Aquatic Sediment	Ponds 1-4 (Southern Ponds)	Arsenic and dioxin TEQ are the primary risk drivers in Pond 1-4 sediment. Risks evaluated in the BHHERA indicate ELCR of 8E-06 for sediments 0-0.5 feet in depth and 7E-06 for sediments 0-2 feet in depth.	No Action	Site remains as is; provide no additional control or action to protect human health or the environment from affected sediment.	No	No	Low	Low	High	High	\$0
			Institutional Controls	Restrict future land use via deed restriction and implement risk management plan for soil/sediment based on COIs and associated risks.	Yes	Yes	Moderate	Low	High	High	\$143,000
			Vegetative Soil Cover and Institutional Controls	Provide an upland vegetative cover to cover each individual pond. Eliminate exposure pathways through vegetative containment, and implementation of a deed restriction and risk management plan for soil/sediment based on COIs and associated risks.	Yes	Yes	Moderate	Low	High	Moderate	\$4,616,226
			Excavation and Disposal	Eliminate exposure pathways through soil excavation and disposal offsite at a permitted landfill.	Yes	Yes	High	High	Low	Moderate	\$2,516,640
			Vegetative Sediment Cover and Institutional Controls	Provide a vegetative wetland cover to cover each individual pond. Eliminate exposure pathways through vegetative containment, and implementation of a deed restriction and risk management plan for soil/sediment based on COIs and associated risks.	Yes	Yes	Moderate	Low	High	Moderate	\$2,471,340
	Pond 7	Arsenic and dioxin TEQ are the primary risk drivers in Pond 7 sediment. Risks evaluated in the BHHERA indicate ELCR of 2E-05.	No Action	Site remains as is; provide no additional control or action to protect human health or the environment from affected sediment. Existing beach berm would continue to provide sediment containment.	No	No	Low	Low	High	High	\$0
			Institutional Controls	Restrict future land use via deed restriction and implement risk management plan for soil/sediment based on COIs and associated risks. Beach berm repairs provide improved sediment containment.	Yes	Yes	Moderate	Low	High	High	\$161,000
			Vegetative Soil Cover and Institutional Controls	Provide an upland vegetative cover to cover the pond. Eliminate exposure pathways through vegetative containment, and implementation of a deed restriction and risk management plan for soil/sediment based on COIs and associated risks. Beach berm repairs provide improved sediment containment.	Yes	Yes	Moderate	Low	High	Moderate	\$610,020
			Excavation and Disposal	Eliminate exposure pathways through soil excavation and disposal offsite at a permitted landfill. Beach berm repairs provide improved sediment containment.	Yes	Yes	High	High	Low	Moderate	\$525,720
			Vegetative Sediment Cover and Institutional Controls	Provide a vegetative wetland cover to cover the pond. Eliminate exposure pathways through vegetative containment, and implementation of a deed restriction and risk management plan for soil/sediment based on COIs and associated risks. Beach berm repairs provide improved sediment containment.	Yes	Yes	Moderate	Low	High	Moderate	\$481,020

Table 4-4: Comparison of Remedial Alternatives

Media	AOC	Risk Summary	Alternative	Description	Threshold (Yes or No) Criteria		Balancing (Low, Moderate, or High) Criteria				
					Overall Protection of Human Health and the Environment	Compliance with ARARs	Long Term Effectiveness and Permanence	Reduction of Toxicity, Mobility, or Volume Through Treatment	Short Term Effectiveness	Implementability	Cost
Aquatic Sediment (cont.)	North Pond and Pond 6	Arsenic and dioxin TEQ are the primary risk drivers in Pond 6 sediment, while arsenic was the primary risk contributor in North Pond sediment. Risks evaluated in the BHHERA indicate ELCR of 2E10-6.	No Action	Site remains as is; provide no additional control or action to protect human health or the environment from affected sediment. Existing beach berm would continue to provide sediment containment.	No	No	Low	Low	High	High	\$0
			Institutional Controls	Restrict future land use via deed restriction and implement risk management plan for soil/sediment based on COIs and associated risks. Beach berm repairs provide improved sediment containment.	Yes	Yes	Moderate	Low	High	High	\$162,000
			Vegetative Soil Cover and Institutional Controls	Provide an upland vegetative cover to cover the pond. Eliminate exposure pathways through vegetative containment, and implementation of a deed restriction and risk management plan for soil/sediment based on COIs and associated risks. Beach berm repairs provide improved sediment containment.	Yes	Yes	Moderate	Low	High	Moderate	\$647,880
			Excavation and Disposal	Eliminate exposure pathways through soil excavation and disposal offsite at a permitted landfill.	Yes	Yes	High	High	Low	Moderate	\$1,071,480
			Vegetative Sediment Cover and Institutional Controls	Provide a vegetative wetland cover to cover the pond. Eliminate exposure pathways through vegetative containment, and implementation of a deed restriction and risk management plan for soil/sediment based on COIs and associated risks.	Yes	Yes	Moderate	Low	High	Moderate	\$564,780
	Pond 8	Dioxin TEQ is the primary risk drivers in sediment. Risks evaluated in the BHHERA indicate ELCRs are 2E-6 cumulative with the primary contributors of 1E-6 for dioxin and 1E-6 for arsenic. Arsenic concentrations are at background.	No Action	Site remains as is; provide no additional control or action to protect human health or the environment from affected sediment. Mill Pond Dam continues to provide sediment containment.	No	No	Low	Low	High	High	\$0
			Institutional Controls	Restrict future land use via deed restriction and implement risk management plan for soil/sediment based on COIs and associated risks. Dam repairs provide improved sediment containment.	Yes	Yes	High	Moderate	High	High	\$2,847,870
			In-Situ Soil Mixing and Institutional Controls	Proposes to treat sediment in place through stabilization by the addition of binders and Portland cement to restrict exposure of potential receptors to affected media, and would limit potential direct contact with affected sediment, or infiltration of water. Dam repairs provide improved sediment containment.	Yes	Yes	High	Moderate	Low	Low	\$18,913,400
			Excavation and Disposal	Eliminate exposure pathways through excavation and disposal offsite at a permitted landfill. Dam repairs provide improved sediment containment.	Yes	Yes	High	High	Low	Moderate	\$30,549,000
			Vegetative Sediment Cover and Institutional Controls	Provide a vegetative wetland cover to cover the pond. Eliminate exposure pathways through vegetative containment, and implementation of a deed restriction and risk management plan for soil/sediment based on COIs and associated risks. Dam repairs provide improved sediment containment.	Yes	Yes	Low	Moderate	High	Low	\$12,513,000
			Vegetated Soil Cover and Institutional Controls	Alternative proposes to provide a vegetative cover to cover the pond to restrict exposure of potential receptors to affected media, and would limit potential direct contact with affected sediment, or infiltration of water. Dam repairs provide improved sediment containment.	Yes	Yes	Moderate	Low	High	Low	\$13,447,100

Table 4-4: Comparison of Remedial Alternatives

Media	AOC	Risk Summary	Alternative	Description	Threshold (Yes or No) Criteria		Balancing (Low, Moderate, or High) Criteria				
					Overall Protection of Human Health and the Environment	Compliance with ARARs	Long Term Effectiveness and Permanence	Reduction of Toxicity, Mobility, or Volume Through Treatment	Short Term Effectiveness	Implementability	Cost
Groundwater	IRM and West of IRM TPHd and Lowland Barium	Fuel-related constituents (TPHd) and Barium are the residual COCs. Concentrations of Barium show downward trends near the WQO, which is also the MCL. Concentrations of TPHd show downward trends near the WQO, which is based on the taste and odor threshold.	No Action	Site remains as is; provide no additional control or action to protect human health or the environment from affected groundwater.	No	No	Low	Moderate	High	High	\$0
			Restricted Use	A deed restriction on the AOC, prohibiting the use of groundwater to eliminate exposure to COIs.	Yes	Yes	Moderate	Moderate	High	High	\$65,000
			Monitored Natural Attenuation and Institutional Controls	Periodic sampling of groundwater to evaluate natural biological and chemical remediation of COIs with contingency for potential future remedial actions, and restrict future groundwater use by establishing a deed restriction prohibiting use of onsite groundwater.	Yes	Yes	Moderate	Moderate	High	High	\$73,000
			Enhanced Aerobic Bioremediation, MNA, and Institutional Controls	Injection of calcium peroxide solution for treatment of contaminants followed by periodic groundwater sampling to confirm that WQOs will be reached within a reasonable timeframe. Periodic sampling of groundwater to evaluate natural biological and chemical remediation of COIs with contingency for potential future remedial actions, and restrict future groundwater use by establishing a deed restriction prohibiting use of onsite groundwater. Only effective for petroleum related compounds.	Yes	Yes	High	High	Moderate	Moderate	\$211,000
			Enhanced Anaerobic Bioremediation, MNA, and Institutional Controls	Anaerobic bio-oxidation of COIs followed by treatment through natural attenuation mechanisms. Periodic sampling of groundwater to evaluate natural biological and chemical remediation of COIs with contingency for potential future remedial actions, and restrict future groundwater use by establishing a deed restriction prohibiting use of onsite groundwater. Only effective for petroleum related compounds.	Yes	Yes	High	High	Moderate	Moderate	\$201,100

**Notes:**

Recommended alternatives are outlined with bold lines.

Green shading indicates that the screening criteria is met or has a high ranking in preference.

Yellow shading indicates that the screening criteria is likely met or has a moderate ranking in preference.

Red shading indicates that the screening criteria may not be met or has a low ranking in preference.

**Acronyms:**

- AOC - area of concern
- AOI - area of interest
- ARARs - Applicable or Relevant and Appropriate Requirements
- B(a)P - benzo(a)pyrene
- bgs - below ground surface
- BHHERA - Baseline Human Health and Ecological Risk Assessment - Operable Unit E (ARCADIS, 2015)
- COI - chemical of interest
- cy - cubic yard
- dioxin - polychlorinated dibenzo-p-dioxin (in case of TEQ, 2,3,7,8-tetrachlorodibenzo-p-dioxin [2,3,7,8-TCDD] in particular)
- ELCR - excess lifetime cancer risk
- ERA - ecological risk assessment
- IRM - interim remedial measure
- NCP - National Oil and Hazardous Substances Pollution Contingency Plan
- PAH - polycyclic aromatic hydrocarbon
- PRA - presumptive remedy area
- sf - square feet
- TEQ - toxic equivalent
- TPHd - total petroleum hydrocarbons as diesel
- WQO - Water Quality Objective

**Reference:**

ARCADIS. 2015. *Baseline Human Health and Ecological Risk Assessment – Operable Unit E*, Former Georgia-Pacific Wood Products Facility, Fort Bragg, California. Prepared for Georgia-Pacific LLC. August.

Table 4-5: Remedial Alternative Recommendations Summary

Media	AOC	Primary Risk Drivers	ELCR	Alternative	Objective	Threshold (Yes or No) Criteria		Balancing (Low, Moderate, or High) Criteria				
						Overall Protection of Human Health and the Environment	Compliance with ARARs	Long Term Effectiveness and Permanence	Reduction of Toxicity, Mobility, or Volume Through Treatment	Short Term Effectiveness	Implementability	Cost
Sediment	Ponds 1-4 (Southern Ponds)	Arsenic and dioxin TEQ	2E-6 (12 day 0-2 ft) 2E-6 (12 day 0-0.5 ft) 7E-6 (50 day 0-2 ft) 8E-6 (50 day 0-0.5 ft) All prior to 2017 hot spot removal.	Institutional Controls	Restrict future land use via deed restriction and implement risk management plan for soil/sediment based on COIs and associated risks.	Yes	Yes	Moderate	Low	High	High	\$143,000
	Pond 7	Arsenic and dioxin TEQ	2E-5 Prior to excavation of full footprint in 2017.	Institutional Controls	Restrict future land use via deed restriction and implement risk management plan for soil/sediment based on COIs and associated risks. Beach berm repairs provide improved sediment containment.	Yes	Yes	Moderate	Low	High	High	\$161,000
	North Pond and Pond 6	Arsenic and dioxin TEQ	2E-6 (North) 3E-6 (Pond 6 0-2ft) 4E-6 (Pond 6 0-0.5 ft)	Institutional Controls	Restrict future land use via deed restriction and implement risk management plan for soil/sediment based on COIs and associated risks. Beach berm repairs provide improved sediment containment.	Yes	Yes	Moderate	Low	High	High	\$162,000
	Pond 8	Dioxin TEQ	2E-6 (1E-6 each for Dioxin and Arsenic, Arsenic concentrations are at background)	Institutional Controls	Restrict future land use via deed restriction and implement risk management plan for soil/sediment based on COIs and associated risks. Mill Pond Dam repairs provide improved sediment containment.	Yes	Yes	High	Moderate	High	High	\$2,847,870
Groundwater	IRM and West of IRM	Fuel-related constituents (primarily TPHd) and Barium	NA	Monitored Natural Attenuation and Institutional Controls	Periodic sampling of groundwater to evaluate natural biological and chemical remediation of COIs with contingency for potential future remedial actions, and restrict future groundwater use by establishing a deed restriction prohibiting use of onsite groundwater.	Yes	Yes	Moderate	Moderate	High	High	\$73,000

**Notes:**

Green shading indicates that the screening criteria is met or has a high ranking in preference.

Yellow shading indicates that the screening criteria is likely met or has a moderate ranking in preference.

Red shading indicates that the screening criteria may not be met or has a low ranking in preference.

**Acronyms:**

- AOC - area of concern
- ARARs - Applicable or Relevant and Appropriate Requirements
- COI - chemical of interest
- dioxin - polychlorinated dibenzo-p-dioxin (in case of TEQ, 2,3,7,8-tetrachlorodibenzo-p-dioxin [2,3,7,8-TCDD] in particular)
- ELCR - Excess Lifetime Cancer Risk
- IRM - interim remedial measure
- TEQ - toxic equivalent
- TPHd - total petroleum hydrocarbons as diesel

**Reference:**

ARCADIS. 2015. *Baseline Human Health and Ecological Risk Assessment – Operable Unit E*, Former Georgia-Pacific Wood Products Facility, Fort Bragg, California. Prepared for Georgia-Pacific LLC. August.

## Figures

---

\\SFO\SGDATA\Z\_Drive\Projects\FortBragg\SiteEvents\20200723\_OUERAP\Fig01\_SiteMap.mxd Printed by: RachelMorgan

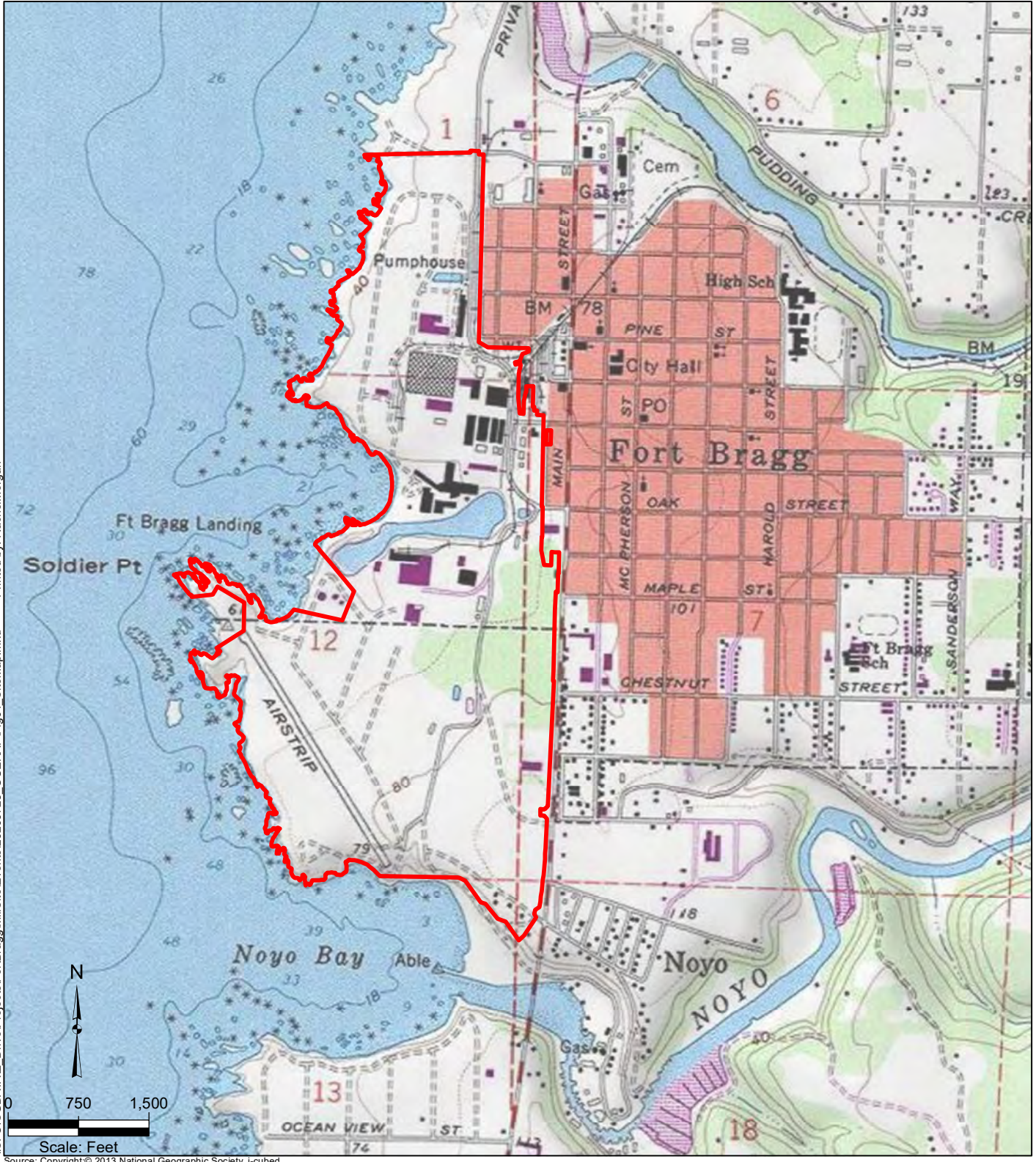

Source: Copyright:© 2013 National Geographic Society, i-cubed

**Legend**

 Site Boundary

**Kennedy/Jenks Consultants**

Former Georgia-Pacific Wood Products Facility  
Fort Bragg, California

**Site Location Map**

1665018\*20

**Figure 1-1**

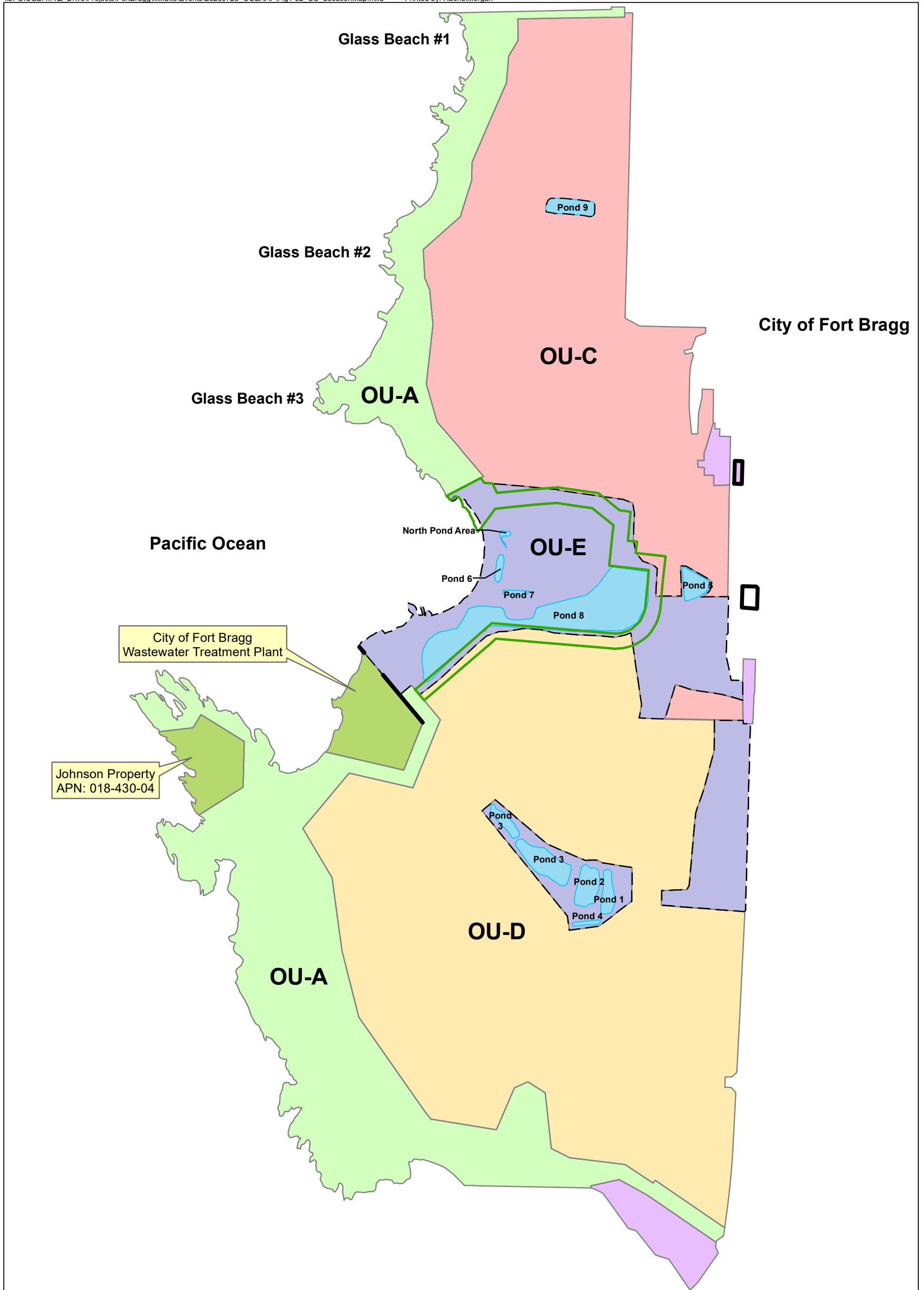

<b>Legend</b>		Abbreviation: OU = Operable Unit		<p>Scale: Feet</p>	<p><b>Kennedy/Jenks Consultants</b> Former Georgia-Pacific Wood Products Facility Fort Bragg, California</p> <p><b>Operable Units Location Map</b></p>
Approximate Central Coastal Trail Property (City of Fort Bragg) Site Boundary Pond Property Owned by Others	<p><b>OPERABLE UNITS</b></p> OU-A "OFFSITE" NON-INDUSTRIAL (OU-B) NORTHERN (OU-C) SOUTHERN (OU-D) CENTRAL/AQUATIC (OU-E)				



Legend

- SITE BOUNDARY
- NEWLY IDENTIFIED POND 8 FILL AREA AOIS
- AOI BOUNDARY
- OU-E BOUNDARY
- OU-A BOUNDARY
- APPROXIMATE CENTRAL COASTAL TRAIL PROPERTY (CITY OF FORT BRAGG)
- PONDS
- AREA OF CONCERN BOUNDARY

AREAS OF CONCERN:

- A OUE LOWLAND
- B SOUTHERN PONDS
- C POND 5
- D POND 6
- E POND 7
- F NORTH POND
- G POND 8
- H POND 9

ACRONYMS:  
AOI - AREA OF INTEREST  
OU - OPERABLE UNIT

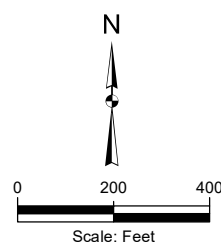

**Kennedy/Jenks Consultants**

Former Georgia-Pacific Wood Products Facility  
Fort Bragg, California

**OU-E Area of Interest Map  
and Associated Features**



\\SFOISGDATA\Z\_Drive\Projects\FortBragg\MillSite\Events\20200723\_OUERAP\Fig1-04\_OUE\_AOI\_Map.mxd Printed by: RachelMorgan

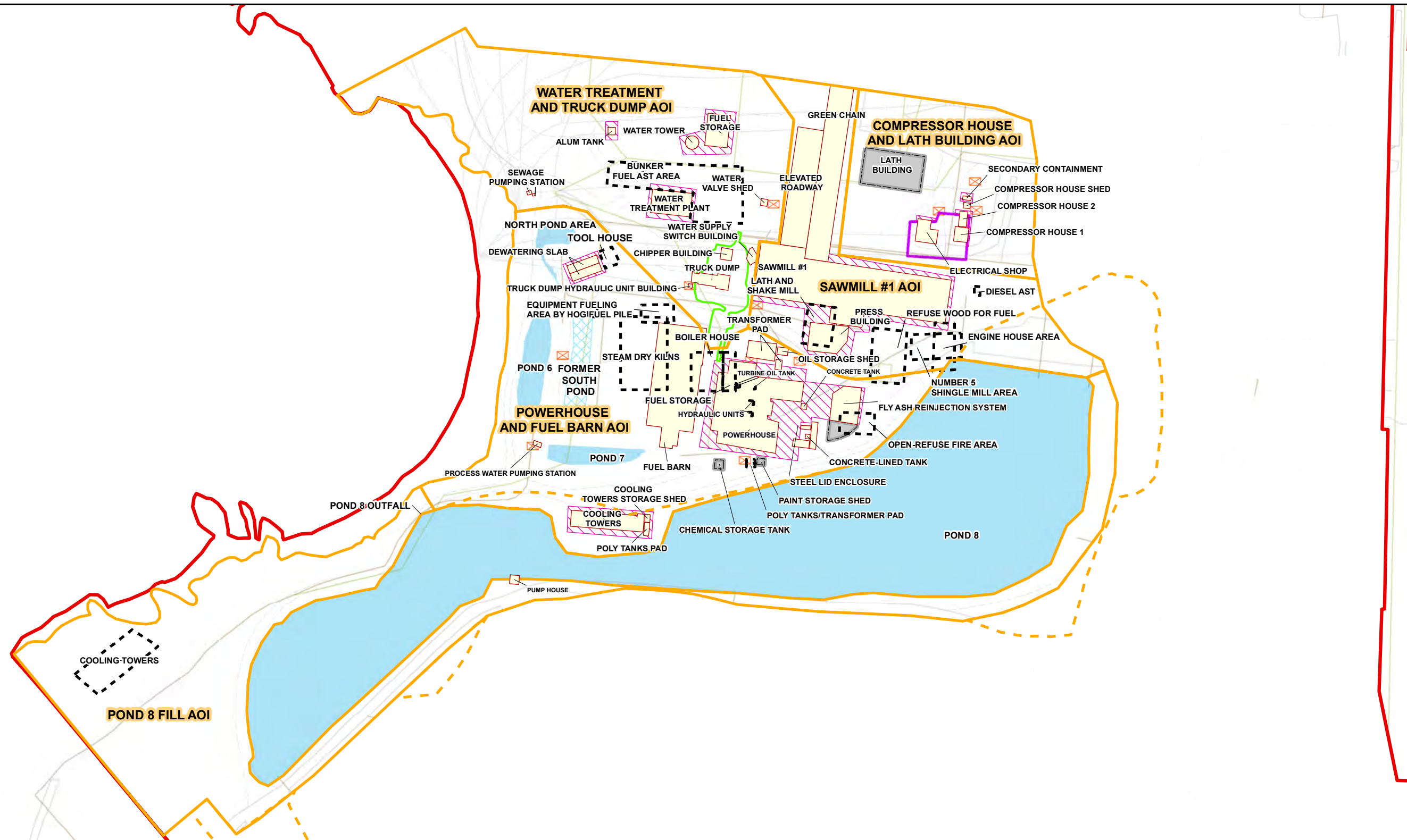

**Legend**

- |                                     |                                      |  |   |
|-------------------------------------|--------------------------------------|--|---|
| AOI BOUNDARY                        | OTHER OPERABLE UNITS/AOIs            | APPROXIMATE CAP BOUNDARIES                   | FORMER RAIL LINES                         |
| SITE BOUNDARY                       | POND                                 | FORMER INDUSTRIAL USE (APPROXIMATE LOCATION) | FORMER TRANSFORMER LOCATION (APPROXIMATE) |
| STRUCTURE                           | FORMER POND                          | NEWLY IDENTIFIED POND 8 FILL AREAS AOIs      | PLANT DRAIN SYSTEM LINE                   |
| FORMER STRUCTURE                    | COMPRESSOR HOUSE EXCAVATION BOUNDARY | SANITARY SEWER LINE                          |   |
| FORMER STRUCTURE- FOUNDATION INTACT | FUEL LINE EXCAVATION BOUNDARY        | UNPAVED ROADWAY                              |   |
|                                     |                                      | PAVED ROADWAY                                |   |

ABBREVIATIONS:

AOI = Area of Interest  
 AST = Aboveground Storage Tank

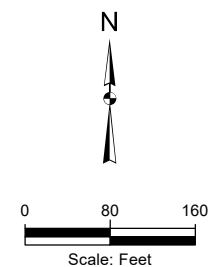

**Kennedy/Jenks Consultants**

Former Georgia-Pacific Wood Products Facility  
 Fort Bragg, California





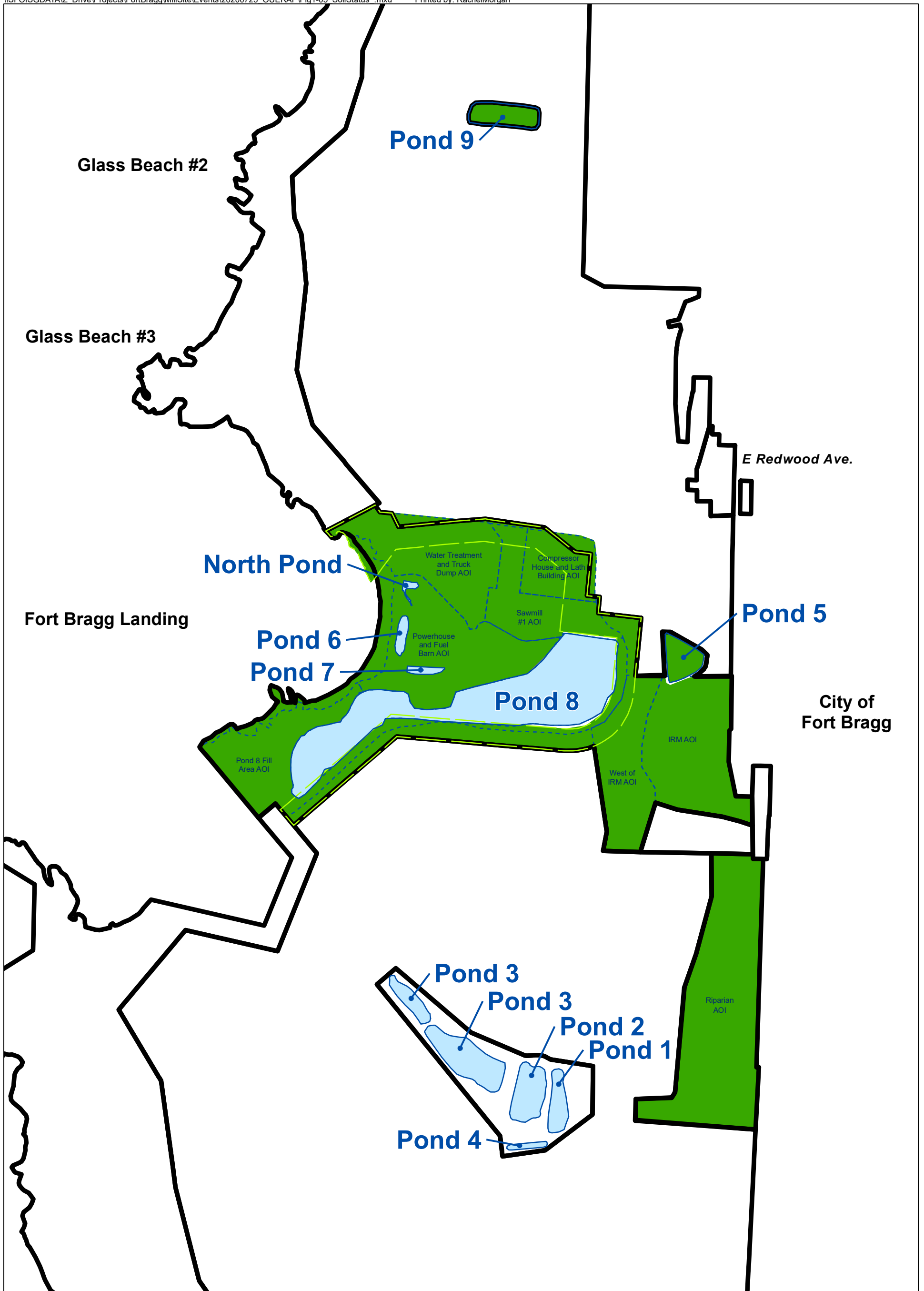

**OU-E Terrestrial AOIs and Associated Features**

1665018\*20

**Figure 1-4**



**Legend**

-  Pond
-  Operable Unit Boundary
-  Approximate Central Coastal Trail Property (City of Fort Bragg)
-  Area of Interest (AOI)
-  No Further Action
-  Sediment Evaluated in Remedial Action Plan

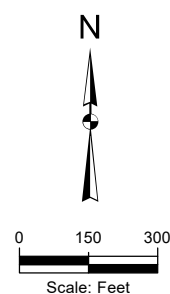

**Kennedy/Jenks Consultants**

Former Georgia-Pacific Wood Products Facility  
Fort Bragg, California

**OU-E Soil and Sediment Status**

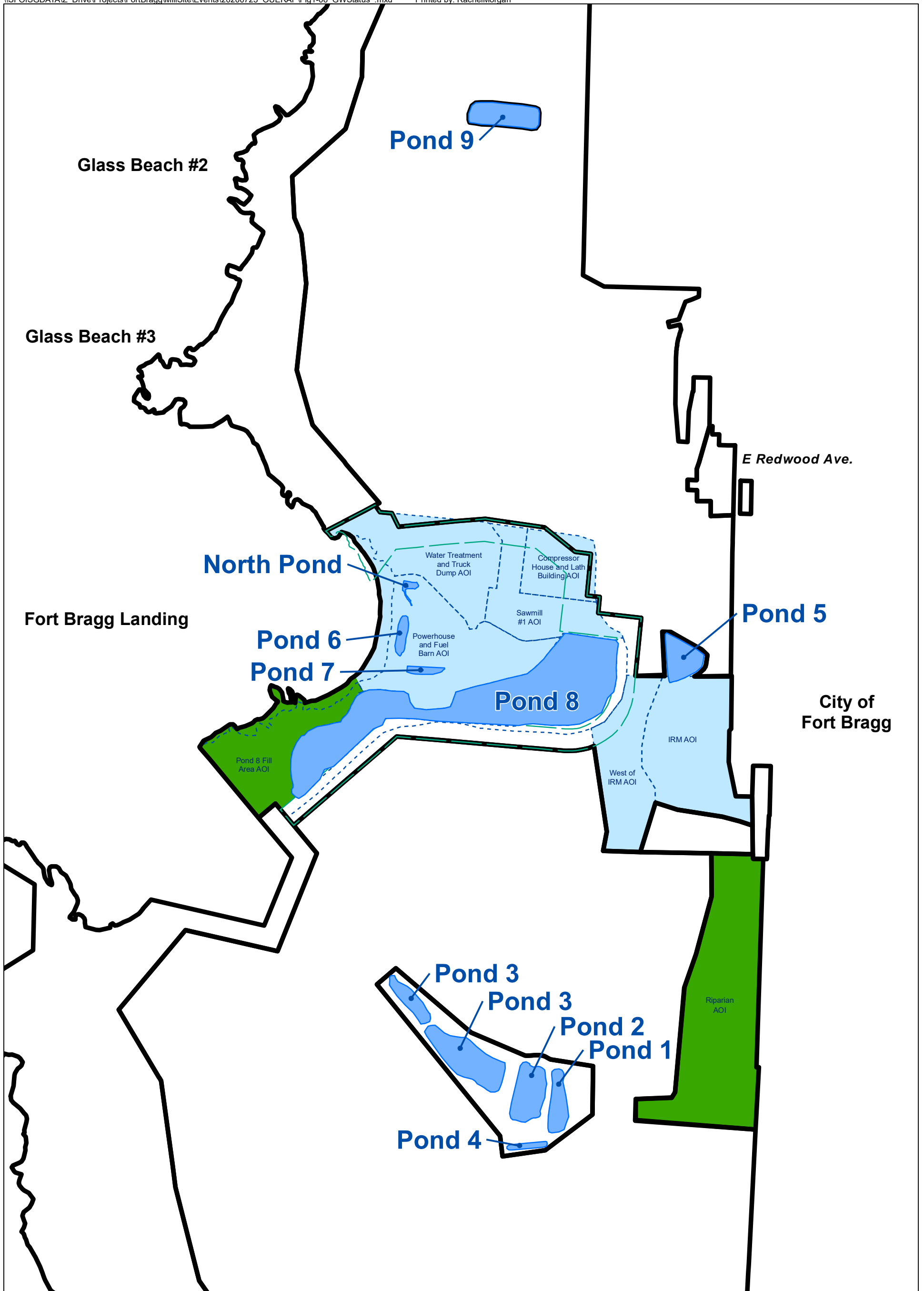

**Legend**

-  Pond
-  Operable Unit Boundary
-  Approximate Central Coastal Trail Property (City of Fort Bragg)
-  Area of Interest (AOI)
-  No Further Action
-  Groundwater Evaluated in Remedial Action Plan

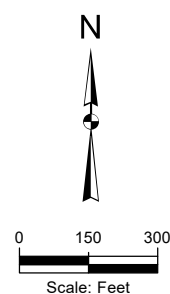

**Kennedy/Jenks Consultants**  
Former Georgia-Pacific Wood Products Facility  
Fort Bragg, California

**OU-E Groundwater Status**

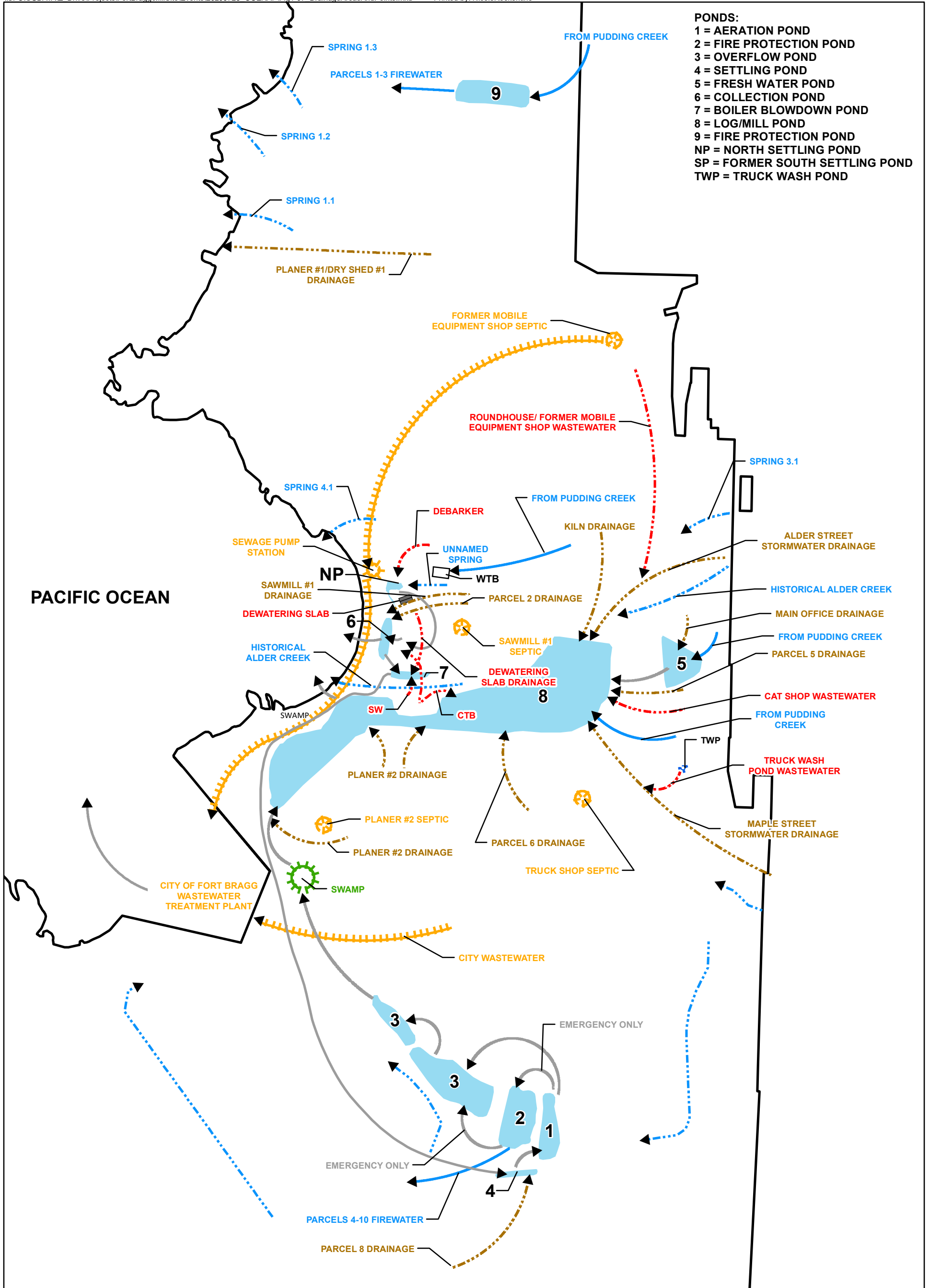

- PONDS:**  
 1 = AERATION POND  
 2 = FIRE PROTECTION POND  
 3 = OVERFLOW POND  
 4 = SETTLING POND  
 5 = FRESH WATER POND  
 6 = COLLECTION POND  
 7 = BOILER BLOWDOWN POND  
 8 = LOG/MILL POND  
 9 = FIRE PROTECTION POND  
 NP = NORTH SETTTLING POND  
 SP = FORMER SOUTH SETTTLING POND  
 TWP = TRUCK WASH POND

- Legend**
- > Schematic Representation Of Hydraulic Connection
  - > Fresh Water
  - - -> Stormwater
  - - -> Septic System/ Domestic Wastewater
  - - -> Industrial Wastewater
  - - -> Natural Drainage/Wetland
  - ||||| SWAMP

- Site Boundary
- Pond

**Notes:**  
 1. Flow Lines And Routes Are Schematic Representations And Should Not Be Construed To Indicate Actual Physical Conditions

**Acronyms:**  
 CTB - Cooling Tower Blowdown  
 SW - Scrubber Washwater  
 WTB - Water Treatment Building

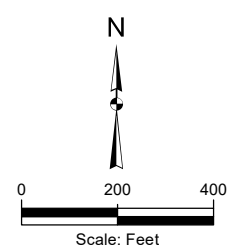





**Kennedy/Jenks Consultants**  
 Former Georgia-Pacific Wood Products Facility  
 Fort Bragg, California

**Drainage Areas and Discharge Points**



**Legend**

-  Present in 1952
-  Constructed between 1957 and 1963
-  Constructed between 1966 and 1973
-  Constructed between 1973 and 1982
-  Current Extent (Constructed between 1982 and 1998)

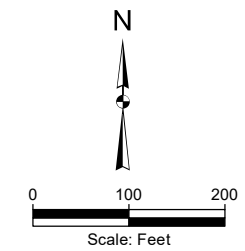

1952: Pond 2 visible



1957: Pond 2 visible



1963: Ponds 1 and 2 visible



1966: Ponds 1 and 2 visible



1973: Ponds 1-3 visible



1982: Ponds 1-3 visible



1998: Ponds 1-4 visible

**Kennedy/Jenks Consultants**  
 Former Georgia-Pacific Wood Products Facility  
 Fort Bragg, California

**Construction of Ponds 1-4**



**Legend**

Maximum Historical Extent

Current Extent

**Filled Areas (based on historical aerial photographs)**

Filled between 1966 and 1973

Filled between 1973 and 1982

Filled between 1982 and 1998

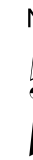

Scale: Feet



1966



1973



1982



1998

**Kennedy/Jenks Consultants**

Former Georgia-Pacific Wood Products Facility  
Fort Bragg, California

**Historical Extent of Pond 8**



**Land Use Plan**

Low Density Residential	Multi-Family	Industrial	Public Facilities
Central Business District	Light Industrial	Open Space	Parks
Visitor	Mill Site Employment	Ponds	Highway Commercial
			Urban Reserve

**Ponds**

- ① Southern Pond 1
- ② Southern Pond 2
- ③ Southern Pond 3
- ④ Southern Pond 4
- ⑤ Pond 5
- ⑥ Pond 6 and the North Pond
- ⑦ Pond 7
- ⑧ Pond 8
- ⑨ Pond 9

Note: Land Use Plan was prepared by the City of Fort Bragg during the Mill Site rezoning process in December 2017. <https://city.fortbragg.com/606/Mill-Site-Rezoning-Process>

**Kennedy/Jenks Consultants**

Former Georgia-Pacific Wood Products Facility  
Fort Bragg, California

**Future Land Development**



**NOTES:**  
 1. WATERS/WETLANDS BOUNDARIES PREVIOUSLY DELINEATED BY WRA (2009) WERE APPROVED BY THE USACE ON MARCH 15, 2010. HOWEVER, NOT ALL DELINEATED WATERS/WETLANDS WERE CLAIMED AS JURISDICTIONAL BY THE USACE. USACE FILE # 2009-00372N.  
 2. ESHA - ENVIRONMENTALLY SENSITIVE HABITAT AREAS  
 3. THREE-PARAMETER WETLANDS ARE DEFINED AS WETLANDS WHERE:  
 1) EVIDENCE OF WETLAND HYDROLOGY, HYDRIC SOIL, AND HYDROPHYTIC VEGETATION WERE PRESENT DURING FIELD INVESTIGATIONS, OR  
 2) LACK OF EVIDENCE FROM ONE OR MORE OF THE THREE PARAMETERS WAS DUE TO PROBLEMATIC/DISTURBED CONDITIONS.

**REFERENCES:**  
 WRA 2009. DELINEATION OF POTENTIAL SECTION 404 JURISDICTIONAL WETLANDS AND WATERS. FORMER GEORGIA-PACIFIC FORT BRAGG WOOD PRODUCTS FACILITY, FORT BRAGG, MENDOCINO COUNTY, CALIFORNIA. PREPARED FOR GEORGIA-PACIFIC, LLC. SEPTEMBER.  
 ARCADIS. 2011. ENVIRONMENTALLY SENSITIVE HABITAT AREAS DELINEATION REPORT. PREPARED FOR GEORGIA-PACIFIC LLC. APRIL.

**Legend**

- Soil Pit Location
- Operational Unit
- Potential Environmentally Sensitive Habitat Areas (ESHA)**
- Delineated Wet ESHA (ARCADIS 2011; not yet approved)
- Delineated waters/ Wetlands (WRA 2009; approved by the USACE 3/15/10)
- Seasonal Wetland
- Wetland Seep
- Industrial Pond
- Three-parameter wetland

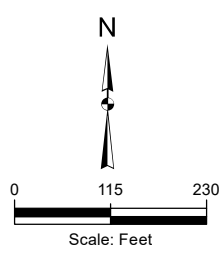

**Kennedy/Jenks Consultants**

Former Georgia-Pacific Wood Products Facility  
 Fort Bragg, California

**Wetlands and Other Wet Environmentally Sensitive Habitat Area – Northern**



\\SFOISGDATA\Z\_Drive\Projects\FortBragg\MilitaryEvents\20200723\_OUERAP\Fig2-03\_WetlandsCentral.mxd Printed by: Rachel Morgan



Source: Esri, DigitalGlobe, GeoEye, Earthstar Geographics, CNES/Airbus DS, USDA, USGS, AeroGRID, IGN, and the GIS User Community

**Legend**

- Soil Pit Location
- Operational Unit
- Potential Environmentally Sensitive Habitat Areas (ESHA)**
- Width Of Delineated Groundwater Seep/Waters Of The State (Arcadis 2010; Not Yet Approved)
- Delineated Wet ESHA (ARCADIS 2011; not yet approved)
- Delineated waters/ Wetlands (WRA 2009; approved by the USACE 3/15/10)
- Approximate Extent of Wetland Establishment Area
- Seasonal Wetland
- Wetland Seep
- Industrial Pond
- Bedrock Groundwater Seep
- Three-parameter wetland

**NOTES:**

1. NOT ALL DELINEATED WATERS/WETLANDS APPROVED BY THE USACE ARE WATERS/WETLANDS OF THE U.S.
2. ESHA - ENVIRONMENTALLY SENSITIVE HABITAT AREAS
3. THREE-PARAMETER WETLANDS ARE DEFINED AS WETLANDS WHERE:
  - 1) EVIDENCE OF WETLAND HYDROLOGY, HYDRIC SOIL, AND HYDROPHYTIC VEGETATION WERE PRESENT DURING FIELD INVESTIGATIONS, OR
  - 2) LACK OF EVIDENCE FROM ONE OR MORE OF THE THREE PARAMETERS WAS DUE TO PROBLEMATIC/DISTURBED CONDITIONS.
4. WETLAND E-6 WAS EXPANDED DURING THE CREATION OF THE WETLAND ESTABLISHMENT AREA. APPROXIMATE NEW WETLAND EXTENT IS SHOWN. WETLAND HAS NOT BEEN DELINEATED SINCE CONSTRUCTION OF THE WETLAND ESTABLISHMENT AREA.

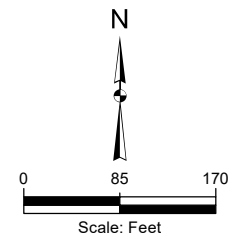

**Kennedy/Jenks Consultants**

Former Georgia-Pacific Wood Products Facility  
Fort Bragg, California

**Wetlands and Other Wet Environmentally Sensitive Habitat Area – Central**

1665018\*20

**Figure 2-3**

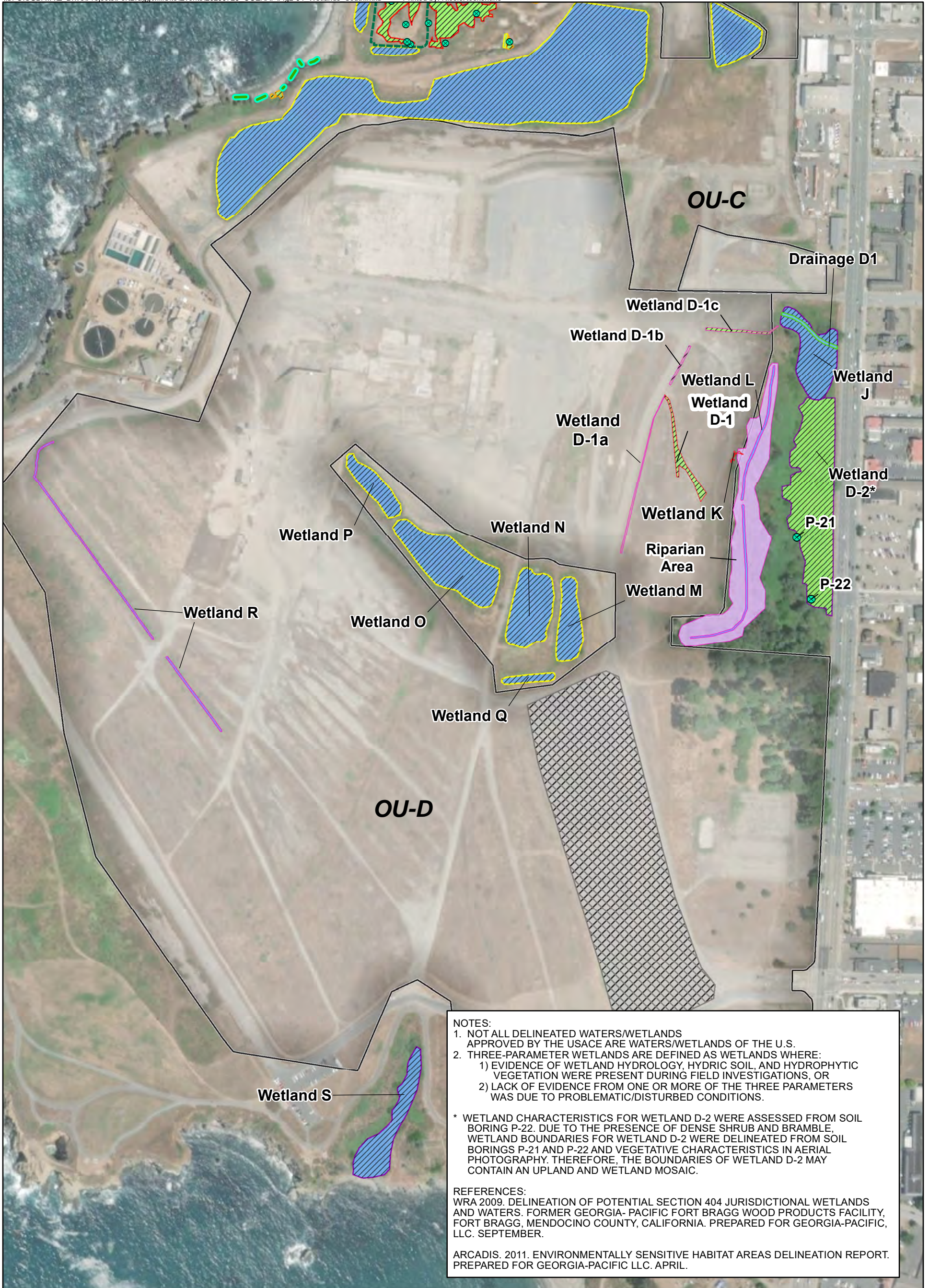

**NOTES:**  
 1. NOT ALL DELINEATED WATERS/WETLANDS APPROVED BY THE USACE ARE WATERS/WETLANDS OF THE U.S.  
 2. THREE-PARAMETER WETLANDS ARE DEFINED AS WETLANDS WHERE:  
 1) EVIDENCE OF WETLAND HYDROLOGY, HYDRIC SOIL, AND HYDROPHYTIC VEGETATION WERE PRESENT DURING FIELD INVESTIGATIONS, OR  
 2) LACK OF EVIDENCE FROM ONE OR MORE OF THE THREE PARAMETERS WAS DUE TO PROBLEMATIC/DISTURBED CONDITIONS.

\* WETLAND CHARACTERISTICS FOR WETLAND D-2 WERE ASSESSED FROM SOIL BORING P-22. DUE TO THE PRESENCE OF DENSE SHRUB AND BRAMBLE, WETLAND BOUNDARIES FOR WETLAND D-2 WERE DELINEATED FROM SOIL BORINGS P-21 AND P-22 AND VEGETATIVE CHARACTERISTICS IN AERIAL PHOTOGRAPHY. THEREFORE, THE BOUNDARIES OF WETLAND D-2 MAY CONTAIN AN UPLAND AND WETLAND MOSAIC.

**REFERENCES:**  
 WRA 2009. DELINEATION OF POTENTIAL SECTION 404 JURISDICTIONAL WETLANDS AND WATERS. FORMER GEORGIA- PACIFIC FORT BRAGG WOOD PRODUCTS FACILITY, FORT BRAGG, MENDOCINO COUNTY, CALIFORNIA. PREPARED FOR GEORGIA-PACIFIC, LLC. SEPTEMBER.  
 ARCADIS. 2011. ENVIRONMENTALLY SENSITIVE HABITAT AREAS DELINEATION REPORT. PREPARED FOR GEORGIA-PACIFIC LLC. APRIL.

**Legend**

- Soil Pit Location
- Operational Unit
- Riparian Area
- Potential Environmentally Sensitive Habitat Areas (ESHA)**
- Width of Delineated Groundwater Seep/Waters of the State (ARCADIS 2011; not yet approved)
- Delineated Wet ESHA (ARCADIS 2011; not yet approved)
- Delineated waters/ Wetlands (WRA 2009; approved by the USACE 3/15/10)

- Approximate Extent of Wetland Establishment Area
- Seasonal Wetland
- Wetland Seep
- Industrial Pond
- Seasonal Wetland Ditch
- Riparian Wetland
- Bedrock Groundwater Seep
- Perennial Waters
- Three-parameter wetland
- Area not evaluated based on ongoing construction activities

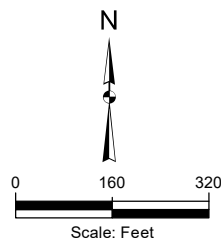

**Kennedy/Jenks Consultants**

Former Georgia-Pacific Wood Products Facility  
 Fort Bragg, California

**Wetlands and Other Wet Environmentally Sensitive Habitat Area – Southern**

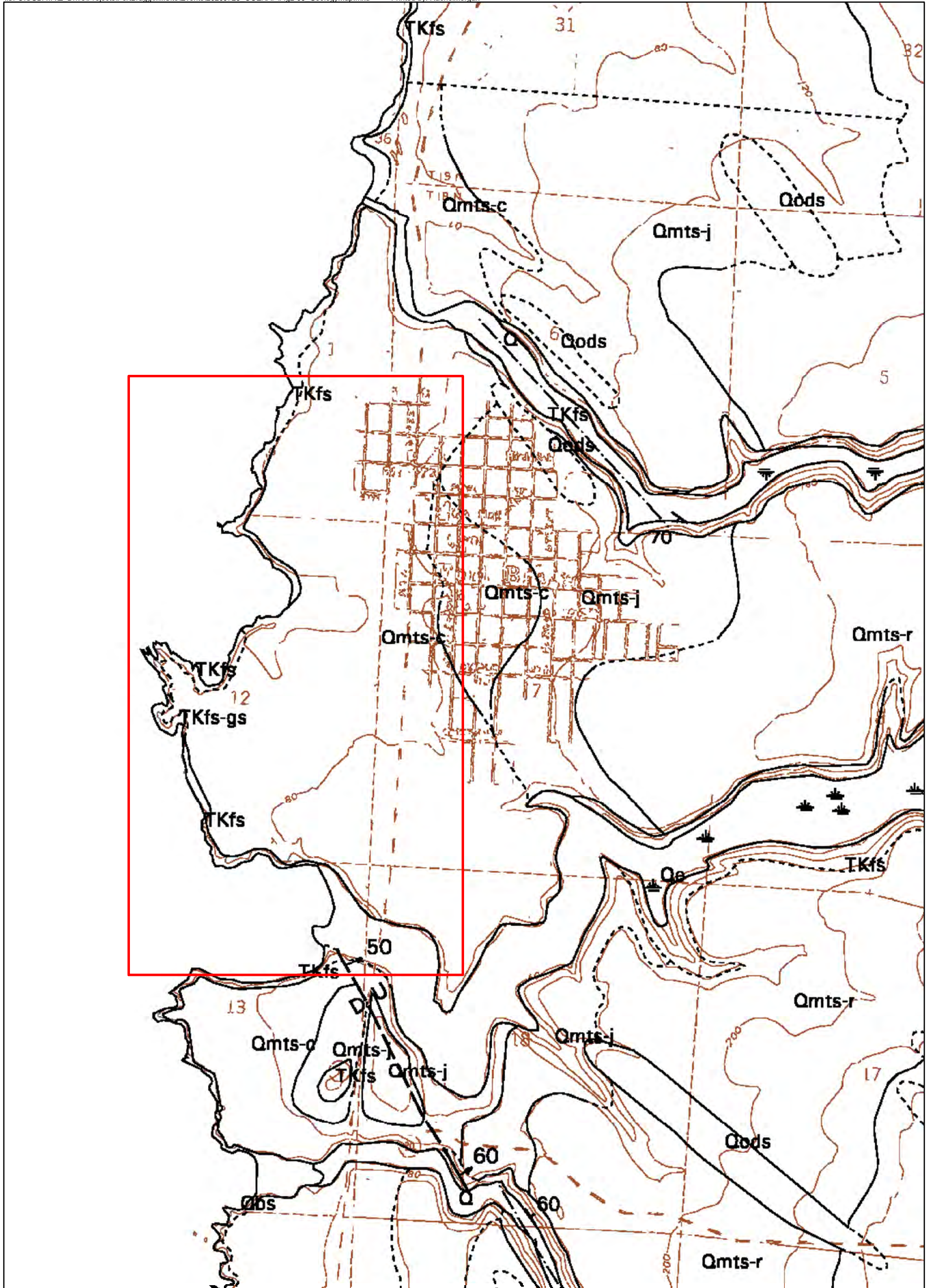

**NOTES:**

1. SOURCE: 1983, DMG OPEN-FILE REPORT 83-05, GEOLOGY AND GEOMORPHIC FEATURES RELATED TO LANDSLIDING, FORT BRAGG 7.5' QUADRANGLE, MENDOCINO COUNTY, CALIFORNIA

2. TKfs = COASTAL BELT FRANCISCAN COMPLEX  
 TKfs-gs = COASTAL BELT FRANCISCAN COMPLEX, GREENSTONE  
 Qmts-c = MARINE TERRACE DEPOSITS, CASPAR POINT  
 Qmts-r = MARINE TERRACE DEPOSITS, CASPAR RAILROAD  
 Qmts-j = MARINE TERRACE DEPOSITS, JUG HANDLE FARM  
 Qods = OLDER DUNE SANDS



**Kennedy/Jenks Consultants**

Former Georgia-Pacific Wood Products Facility  
 Fort Bragg, California

**Geology Map**

1665018\*20  
 Figure 2-5

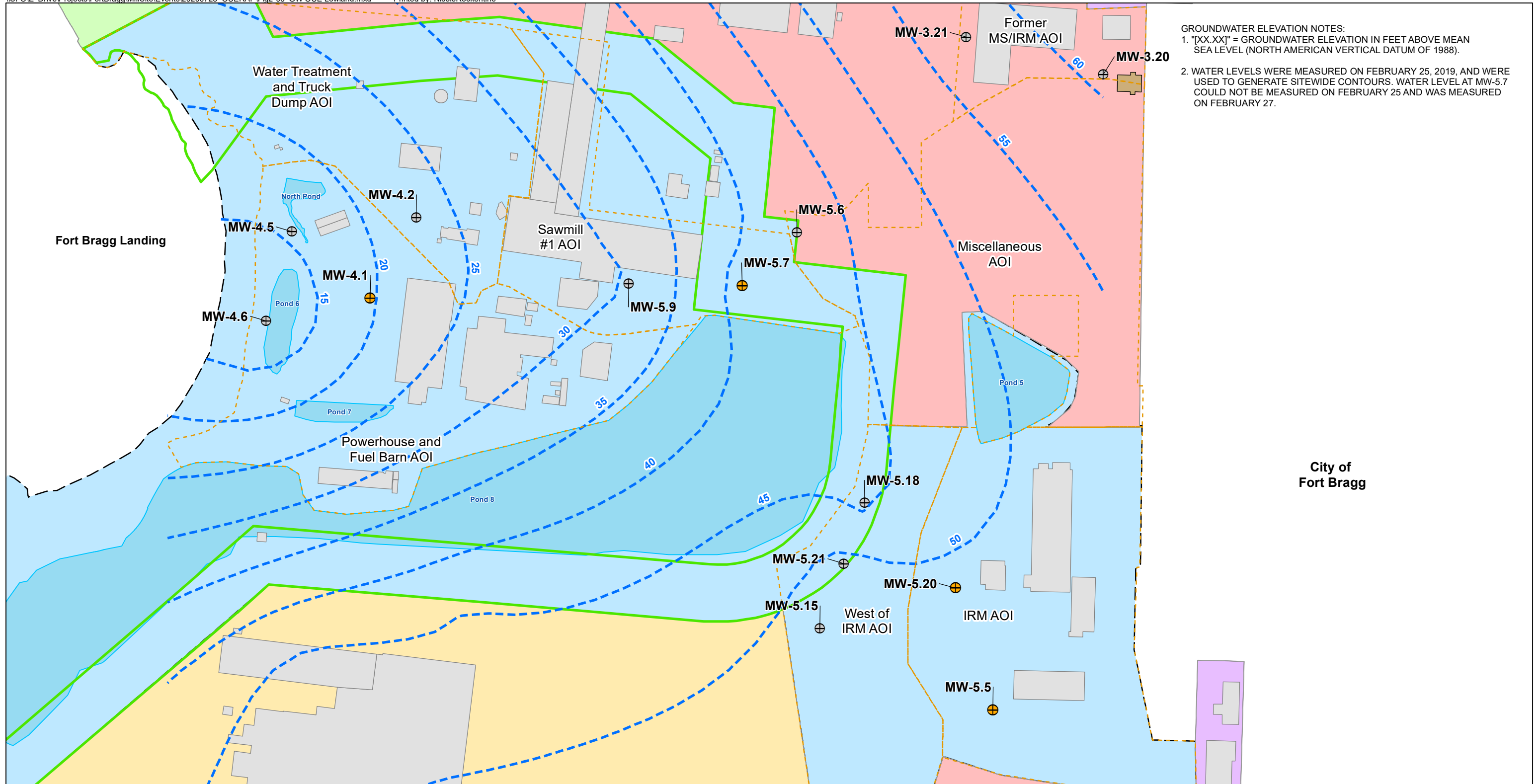

**GROUNDWATER ELEVATION NOTES:**  
 1. "[XX.XX]" = GROUNDWATER ELEVATION IN FEET ABOVE MEAN SEA LEVEL (NORTH AMERICAN VERTICAL DATUM OF 1988).  
 2. WATER LEVELS WERE MEASURED ON FEBRUARY 25, 2019, AND WERE USED TO GENERATE SITEWIDE CONTOURS. WATER LEVEL AT MW-5.7 COULD NOT BE MEASURED ON FEBRUARY 25 AND WAS MEASURED ON FEBRUARY 27.

**Legend**

- Area of Interest (AOI)
- Approximate Central Coastal Trail Property (City of Fort Bragg)
- Structure
- Former Structure
- Pond
- ⊕ O&M Program Monitoring Wells
- ⊕ Monitoring Wells Approved for Future Destruction
- Groundwater Contours

**Operable Units**

- Coastal Trail/Park Acquisition (OU-A)
- "Offsite" Non-Industrial (OU-B)
- Northern (OU-C)
- Southern (OU-D)
- Ponds/Park (OU-E)

**Kennedy/Jenks Consultants**

Former Georgia-Pacific Wood Products Facility  
 Fort Bragg, California

**Monitoring Well Network for Lowlands and IRM and West of IRM AOs**

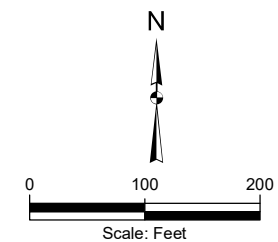

\\SFOISGDATA\Z\_Drive\Projects\FortBragg\MillSiteEvents\20200723\_OUERAP\Fig2-07\_Powerhouse.mxd Printed by: RachelMorgan



**ACRONYMS:**

AOI	AREA OF INTEREST
OU-E	OPERABLE UNIT E
RI	REMEDIAL INVESTIGATION

**Legend**  
**Historical Sample Locations**

- Soil
- ▲ Groundwater
- Soil & Groundwater
- ◆ Sediment
- Sediment/Surface Water
- Surface Water
- ⊕ Monitoring Well
- ⊕ Abandoned Monitoring Well
- Excavated Sample Locations

**RI Sample Locations**

- Surface And Subsurface Soil
- Surface And/Or Subsurface Soil And Groundwater Grab
- Subsurface Soil Sample Only
- Discrete Soil Sample For Composite
- Groundwater Only
- Surface Soil Sample Only
- ◆ Sediment
- Surface Water

- ▭ Site Boundary
- ▭ Other Operable Units/AOIs
- ▭ OU-E Boundary
- ▭ AOI Boundary
- ▭ Former Structure
- ▭ Former Industrial Use (Approximate Location)

- ▭ Former Structure-Foundation Intact
- ▭ Pond
- ▭ Compressor House Excavation Boundary
- ▭ Fuel Line Excavation Boundary
- ▭ Capped Areas
- ▭ Newly Identified Pond 8 Fill Area AOIs

- Plant Drain System Line
- Former Rail Lines
- Retaining Wall

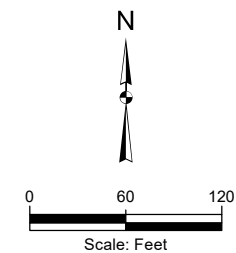

**Kennedy/Jenks Consultants**  
Former Georgia-Pacific Wood Products Facility  
Fort Bragg, California

**Powerhouse and Fuel Barn AOI and Pond 8 Fill Area AOI – Soil, Sediment, Groundwater and Surface Water Sampling Locations**

1665018\*20  
**Figure 2-7**

\\SFOZ\_Drive\Projects\FortBragg\GIS\SiteEvents\20200723\_OUERAP\Fig2-08\_SouthernPondsSamplingLocs.mxd Printed by: NicoleRockentine



ACRONYM:  
OU-E OPERABLE UNIT E

- Legend**
- 2003-2009 Sample Locations**
- ◆ Sediment
  - Sediment/Surface Water
- 2017 Sample Locations**
- ◆ Sediment

- Other Operable Units/AOIs
- OU-E Boundary
- Former Structure
- Pond
- Plant Drain System Line
- Former Rail Lines

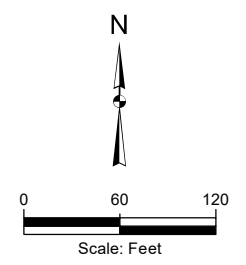

**Kennedy/Jenks Consultants**  
Former Georgia-Pacific Wood Products Facility  
Fort Bragg, California

**Southern Ponds – Sediment and Surface Water Sampling Locations**

\\SFOISGDATA\Z\_Drive\Projects\FortBragg\MillSite\Events\20200723\_OUERAP\Fig2-09\_PondsPondsSamplingLoc.mxd Printed by: NicoleRockentine

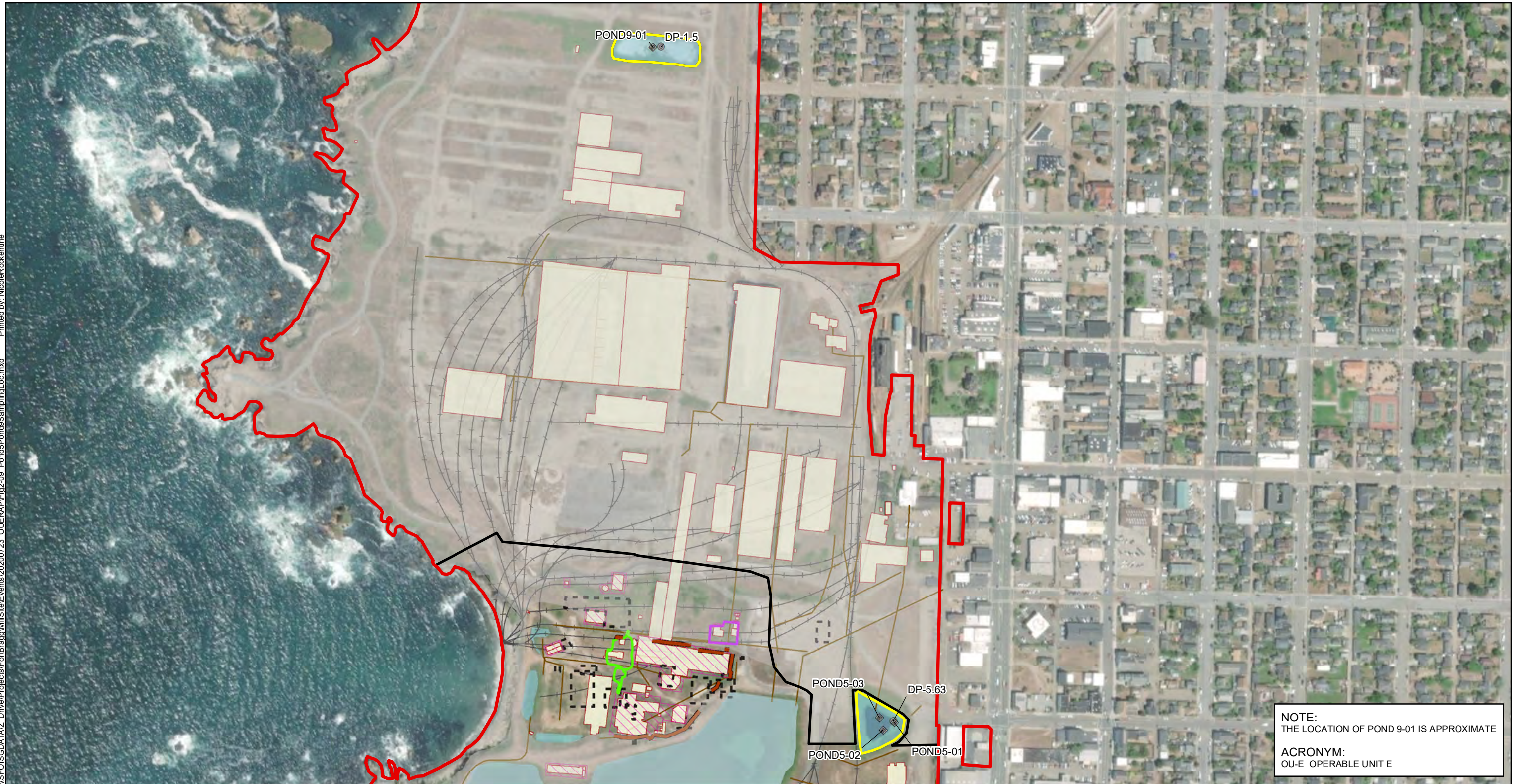

**Legend**  
**2003-2009 Sample Locations**

- ◆ Sediment
- Sediment/Surface Water

- Site Boundary
- OU-E Boundary
- Existing Structure
- Former Structure
- Former Structure - Foundation Intact
- Pond

- Pond 5 and Pond 9
- Compressor House Excavation Boundary
- Fuel Line Excavation Boundary
- approximate cap boundaries
- Former Industrial Use (Approximate Location)

- Plant Drain System Line
- Sanitary Sewer Line
- Unpaved Roadway
- Paved Roadway
- Former Rail Lines

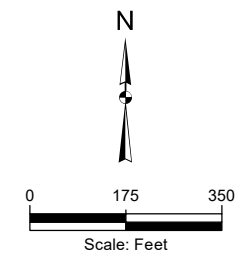

**NOTE:**  
THE LOCATION OF POND 9-01 IS APPROXIMATE

**ACRONYM:**  
OU-E OPERABLE UNIT E

**Kennedy/Jenks Consultants**

Former Georgia-Pacific Wood Products Facility  
Fort Bragg, California

**Pond 5 and Pond 9 – Sediment and Surface Water Sampling Locations**

1665018\*20

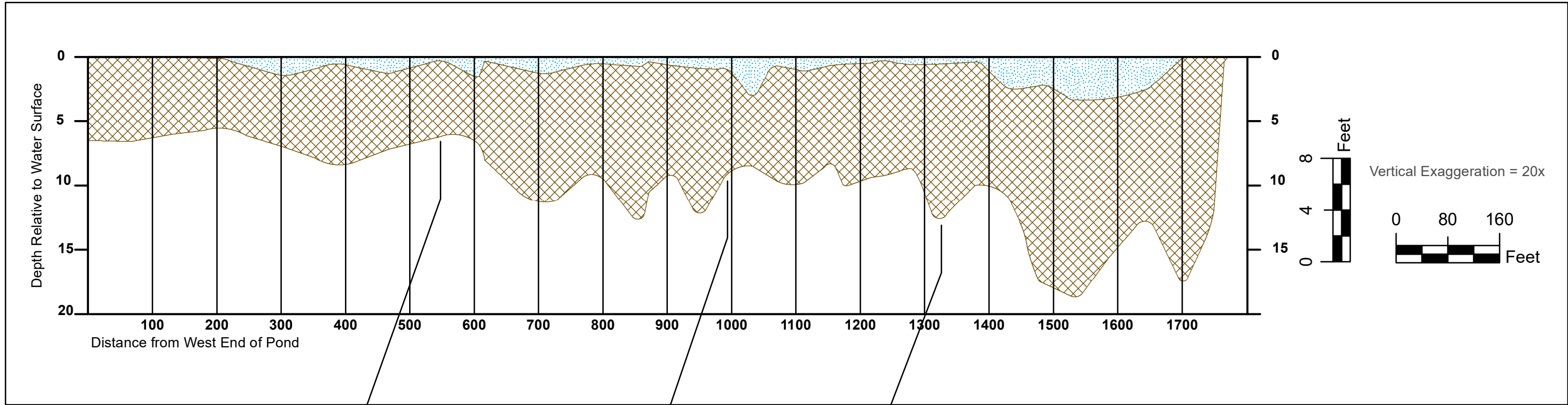
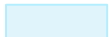
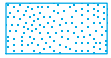

**Figure 2-9**



Service Layer Credits: Source: Esri, Maxar, GeoEye, Earthstar Geographics, CNES/Airbus DS, USDA, USGS, AeroGRID, IGN, and the GIS User Community



**Legend**

-  Transect Location
-  Approximate Pond 8 Extent
-  Water
-  Sediment

**Notes:**

1. A total of eight (8) new sample locations are proposed. A total of twelve (12) samples will be collected.
2. Assumed 2 feet of sample is required per sample based on hand tool collection quantity.
3. Locations shown on plan view and cross-section are approximate.

**Kennedy/Jenks Consultants**

Former Georgia-Pacific Wood Products Facility  
Fort Bragg, California

**Pond 8 Sediment Probe Transect Overview**



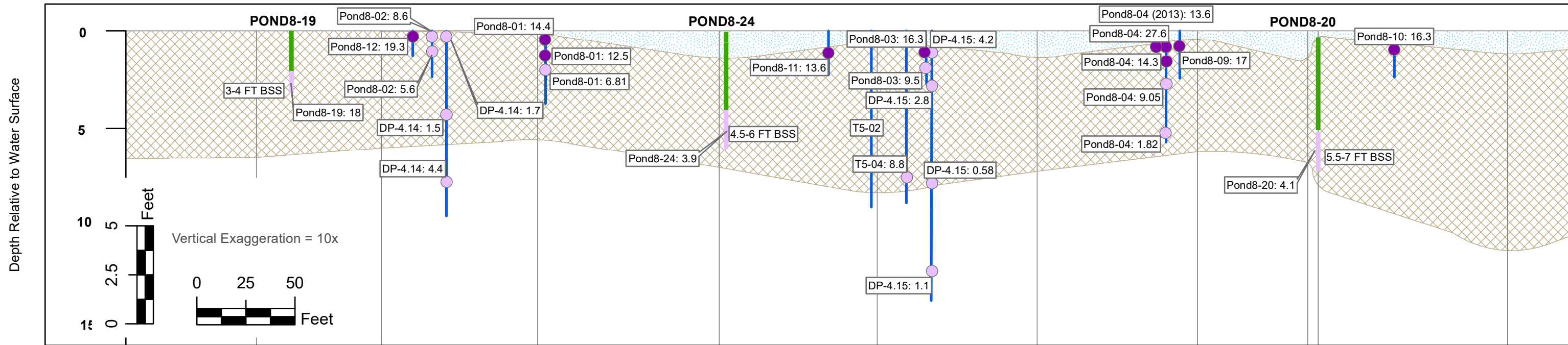

**Legend**

- Sediment Thickness Probe Location (plan view)
  - Boring with Analytical Results (plan view)
  - September 2019 Boring Location (plan view)
  - Sediment Thickness Probe Location (cross section)
  - Boring with Analytical Results (cross section)
  - September 2019 Boring Location
  - Sample Interval Detected Above 10 mg/kg
  - Sample Interval Detected Below 10 mg/kg
  - Water
  - Sediment
- Arsenic Analytical Results**
- Detected Below Background Concentration (10 mg/kg)
  - Detected Above Background Concentration (10 mg/kg)
- T5:04: 8.8 ● Boring ID and Arsenic concentration in mg/kg

**Notes:**

1. A total of eighteen (18) samples were collected from ten (10) new sample locations.
2. Locations shown on plan view and cross-section are approximate.
3. BSS = Below Sediment Surface
4. Pond sediment thickness was projected to the cross section and may not reflect sediment thickness at each sample location shown. Samples are only proposed in pond sediment.

**Kennedy/Jenks Consultants**

Former Georgia-Pacific Wood Products Facility  
Fort Bragg, California

**Pond 8 Sediment Probe Transect  
Arsenic Results: Sheet 1**

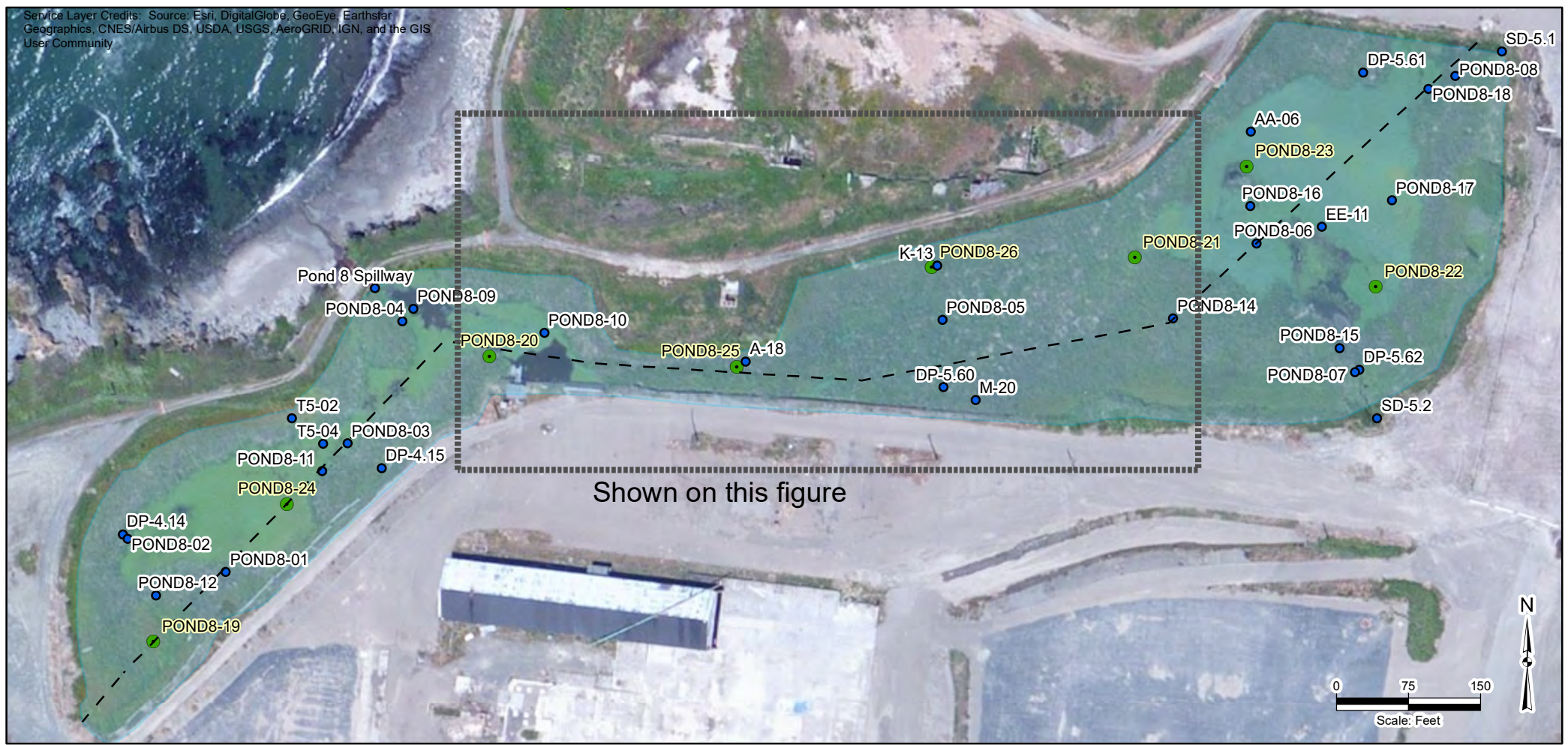
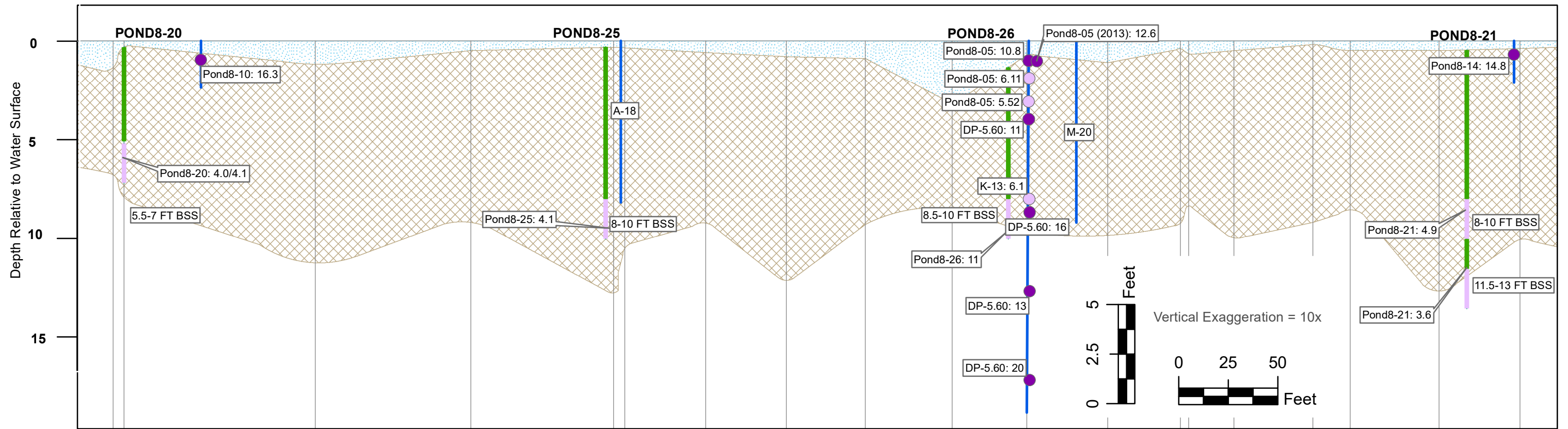

- Legend**
- Sediment Thickness Probe Location (plan view)
  - Boring with Analytical Results (plan view)
  - September 2019 Boring Location (plan view)
  - Sediment Probe Location
  - Boring with Analytical Results (cross section)
  - September 2019 Boring Location
  - Sample Interval Detected Above 10mg/kg
  - Sample Interval Detected Below 10mg/kg
- Arsenic Analytical Results**
- Detected Below Background Concentration (10 mg/kg)
  - Detected Above Background Concentration (10 mg/kg)
  - Water
  - Sediment
- T5:04: 8.8 ● Boring ID and Arsenic concentration in mg/kg

- Notes:**
1. A total of eighteen (18) samples were collected from ten (10) new sample locations.
  2. Locations shown on plan view and cross-section are approximate.
  3. BSS = Below Sediment Surface
  4. Pond sediment thickness was projected to the cross section and may not reflect sediment thickness at each sample location shown. Samples are only proposed in pond sediment.

**Kennedy/Jenks Consultants**  
 Former Georgia-Pacific Wood Products Facility  
 Fort Bragg, California

**Pond 8 Sediment Probe Transect  
 Arsenic Results: Sheet 2**

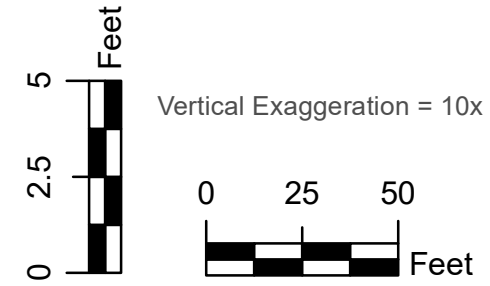
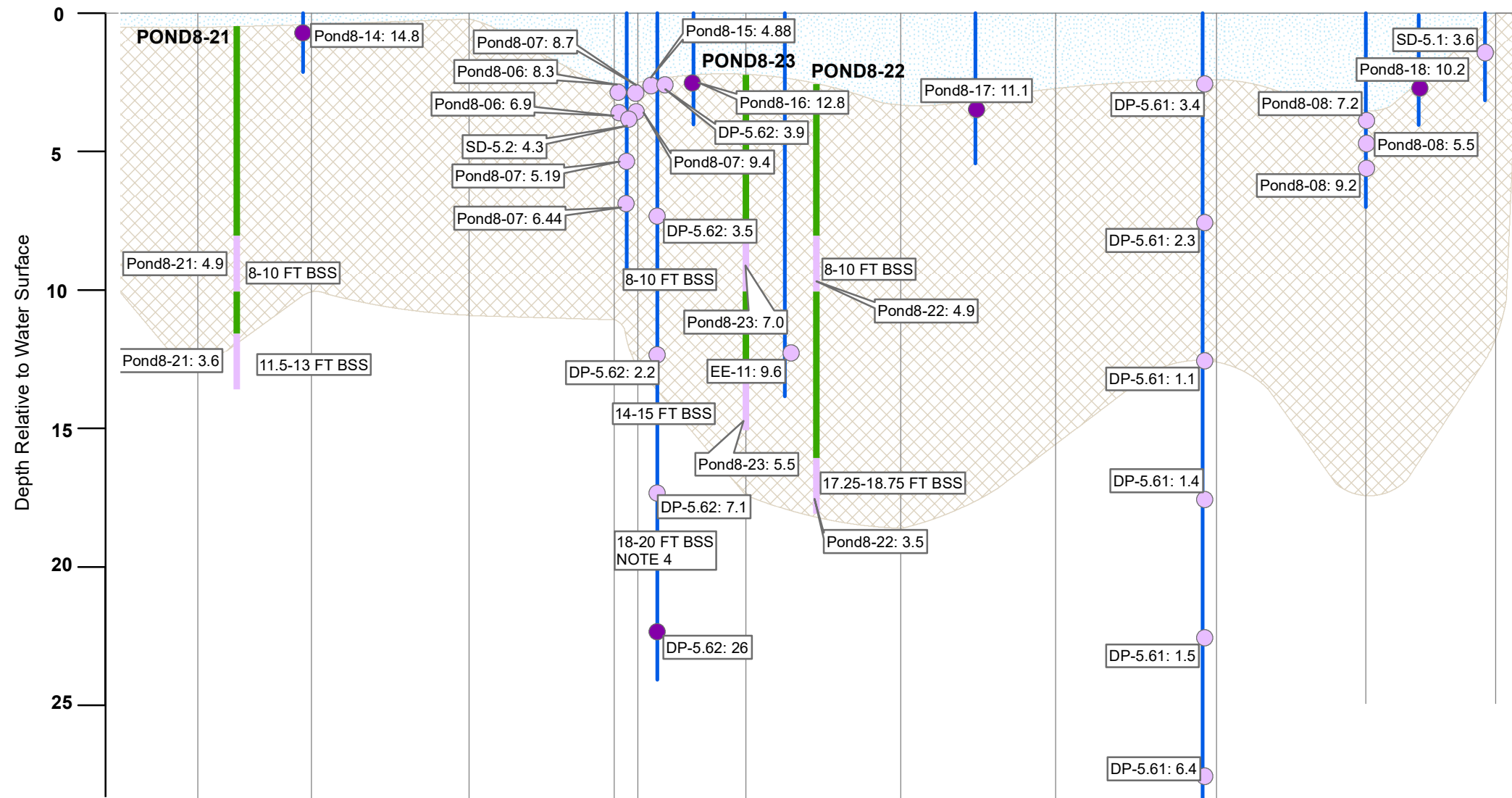

- Sediment Thickness Probe Location (plan view)
- Boring with Analytical Results (plan view)
- September 2019 Boring Location (plan view)
- Sediment Probe Location
- Boring with Analytical Results (cross section)
- September 2019 Boring Location
- Sample Interval Detected Above 10mg/kg
- Sample Interval Detected Below 10mg/kg
- Water
- Sediment
- Arsenic Analytical Results**
- Detected Below Background Concentration (10 mg/kg)
- Detected Above Background Concentration (10 mg/kg)
- T5:04: 8.8 ○ Boring ID and Arsenic concentration in mg/kg



- Notes:
1. A total of eighteen (18) samples were collected from ten (10) new sample locations.
  2. Locations shown on plan view and cross-section are approximate.
  3. BSS = Below Sediment Surface
  4. Pond sediment thickness was projected to the cross section and may not reflect sediment thickness at each sample location shown. Samples are only proposed in pond sediment.

**Kennedy/Jenks Consultants**  
Former Georgia-Pacific Wood Products Facility  
Fort Bragg, California

**Pond 8 Sediment Probe Transect  
Arsenic Results: Sheet 3**

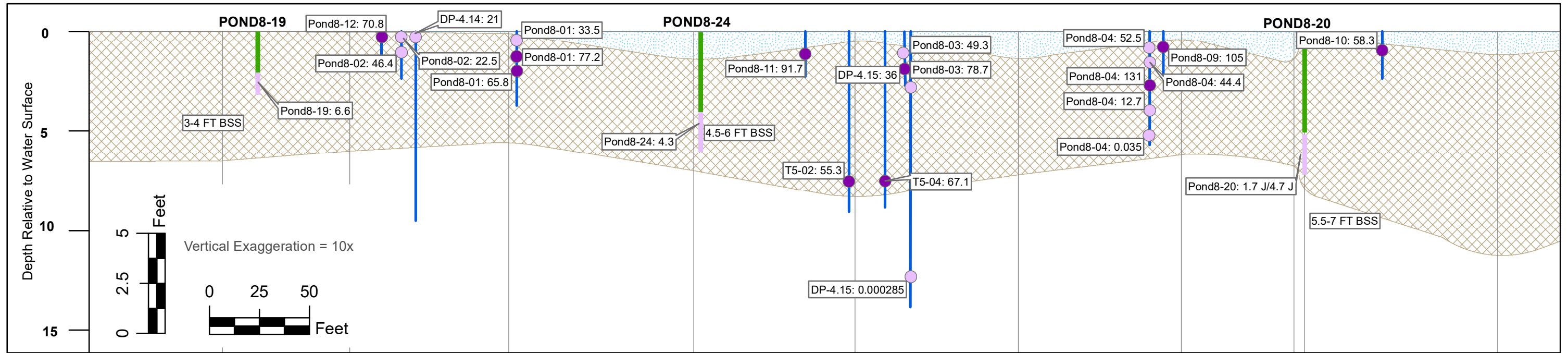

**Legend**

- Sediment Thickness Probe Location (plan view)
  - Boring with Analytical Results (plan view)
  - September 2019 Boring Location (plan view)
  - Sediment Probe Location
  - Boring with Analytical Results
  - September 2019 Boring Location
  - Sample Interval Detected Above 53pg/g
  - Sample Interval Detected Below 53pg/g
  - Water
  - Sediment
- Dioxin Analytical Results**
- Detected Below Draft Site-Specific Cleanup Goal (53 pg/g)
  - Detected Above Draft Site-Specific Cleanup Goal (53 pg/g)
- Boring ID and dioxin concentration in pg/g

**Notes:**

1. A total of eighteen (18) samples were collected from ten (10) new sample locations.
2. Locations shown on plan view and cross section are approximate.
3. BSS = Below Sediment Surface
4. Pond sediment thickness was projected to the cross section and may not reflect sediment thickness at each sample location shown. Samples are only proposed in pond sediment.

**Kennedy/Jenks Consultants**

Former Georgia-Pacific Wood Products Facility  
Fort Bragg, California

**Pond 8 Sediment Probe Transect  
Dioxin Results: Sheet 1**

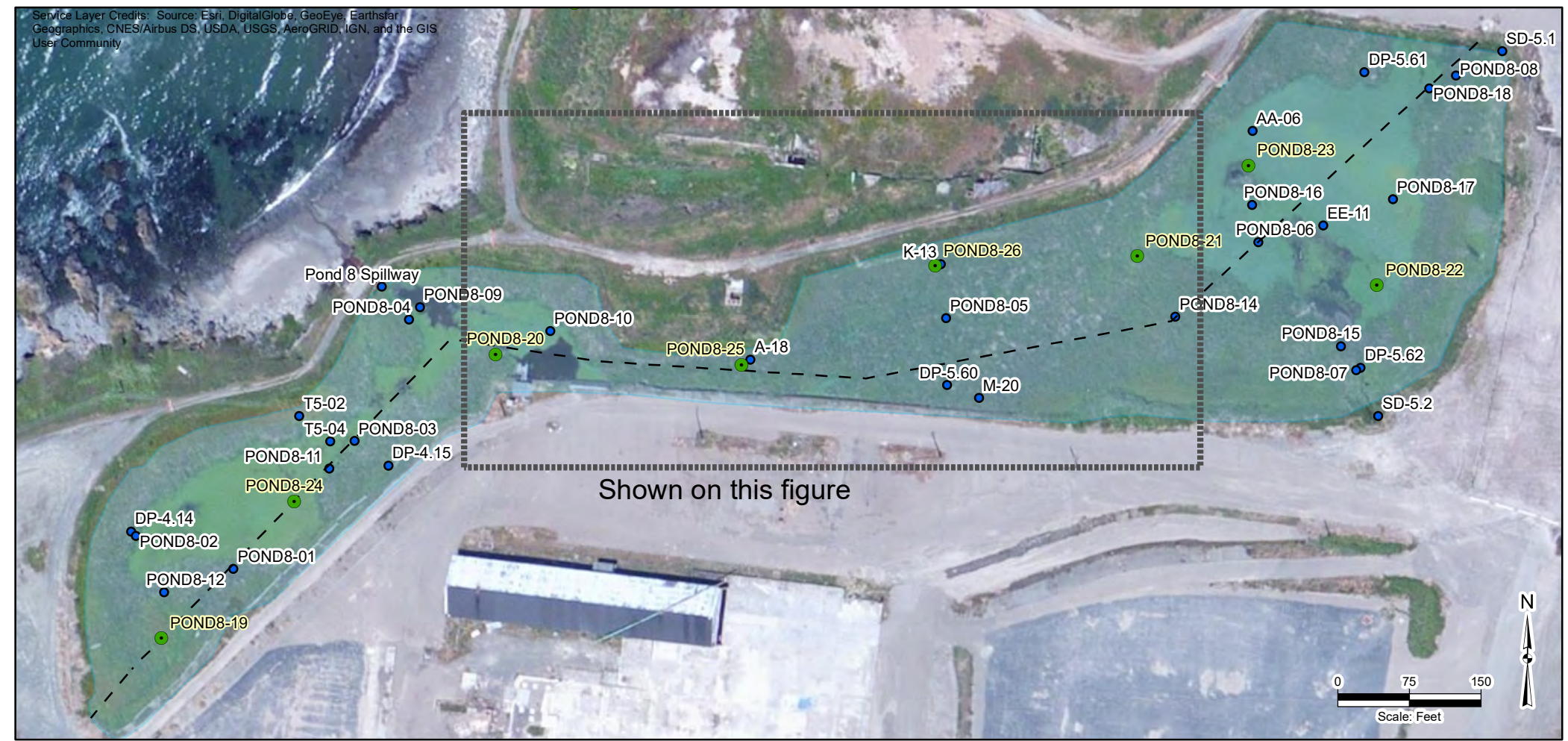
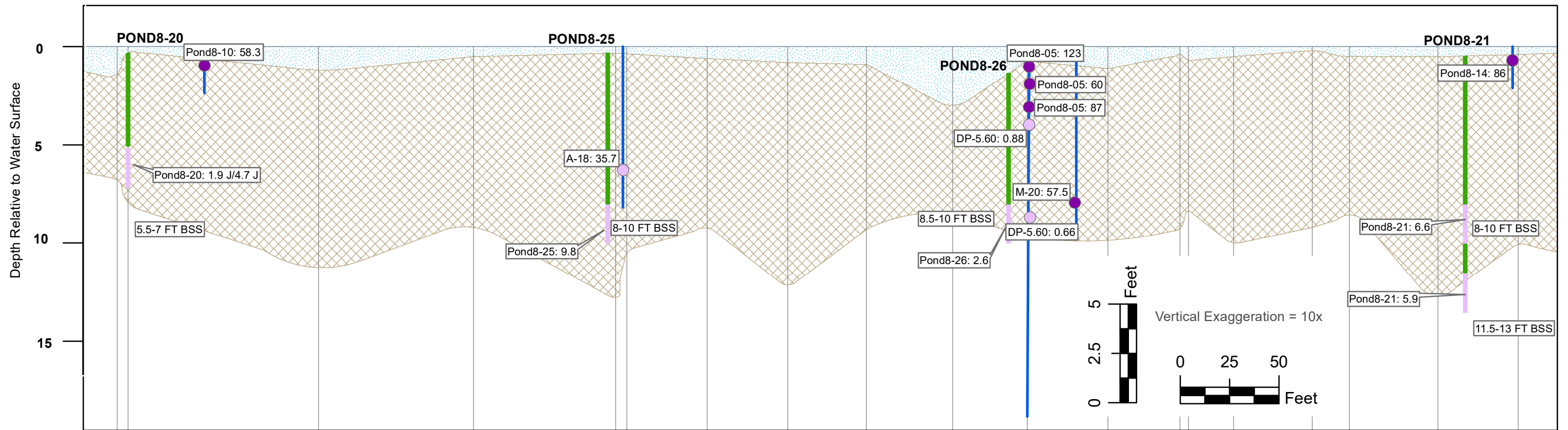

- Legend**
- Sediment Thickness Probe Location (plan view)
  - Boring with Analytical Results (plan view)
  - September 2019 Boring Location (plan view)
  - Sediment Thickness Probe Location (cross section)
  - Boring with Analytical Results (cross section)
  - September 2019 Boring Location
  - Sample Interval Detected Above 53pg/g
  - Sample Interval Detected Below 53pg/g
  - Water
  - Sediment
- Dioxin Analytical Results**
- Detected Below Draft Site-Specific Cleanup Goal (53 pg/g)
  - Detected Above Draft Site-Specific Cleanup Goal (53 pg/g)
- Boring ID and dioxin concentration in pg/g  
 POND8-04: 52.5

- Notes:**
1. A total of eighteen (18) samples were collected from ten (10) new sample locations.
  2. Locations shown on plan view and cross-section are approximate.
  3. BSS = Below Sediment Surface
  4. Pond sediment thickness was projected to the cross section and may not reflect sediment thickness at each sample location shown. Samples are only proposed in pond sediment.

**Kennedy/Jenks Consultants**  
 Former Georgia-Pacific Wood Products Facility  
 Fort Bragg, California

**Pond 8 Sediment Probe Transect  
 Dioxin Results: Sheet 2**

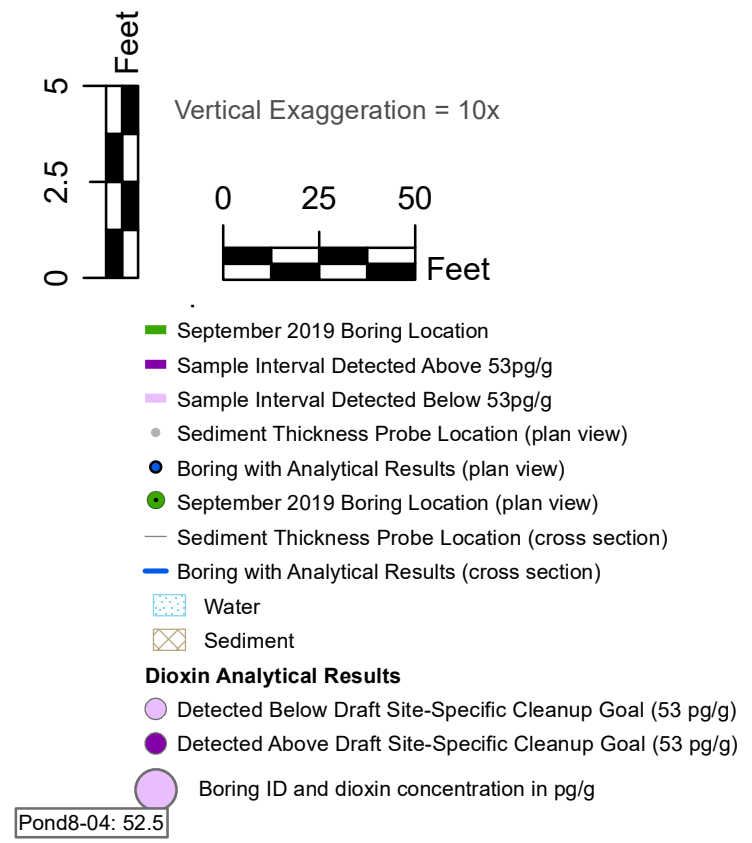
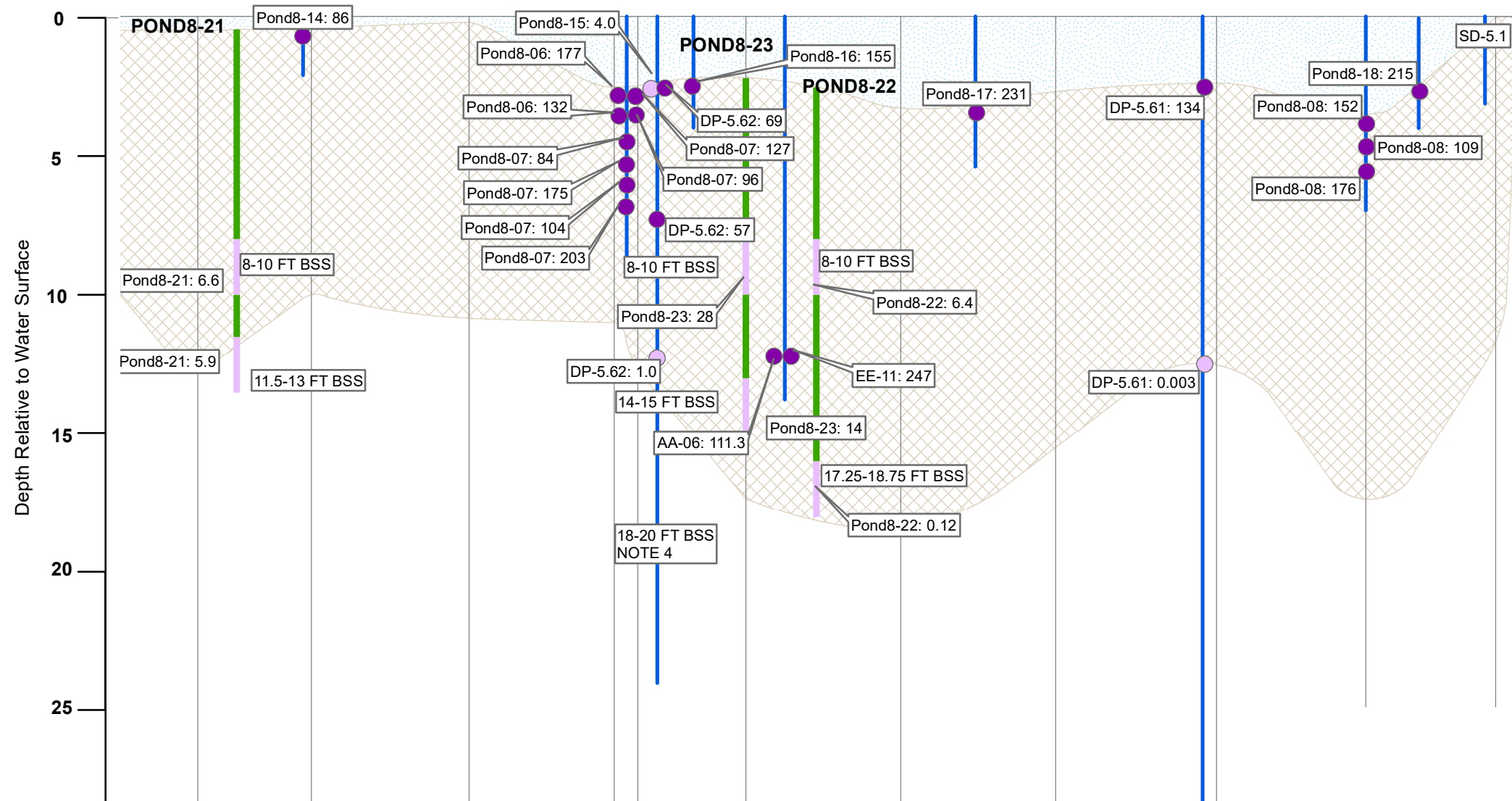

- Notes:
1. A total of eighteen (18) samples were collected from ten (10) new sample locations.
  2. Locations shown on plan view and cross-section are approximate.
  3. BSS = Below Sediment Surface
  4. Pond sediment thickness was projected to the cross section and may not reflect sediment thickness at each sample location shown. Samples are only proposed in pond sediment.

**Kennedy/Jenks Consultants**  
Former Georgia-Pacific Wood Products Facility  
Fort Bragg, California

**Pond 8 Sediment Probe Transect  
Dioxin Results: Sheet 3**

\\SFOISGDATA\Z\_Drive\Projects\FortBragg\MillSiteEvents\20200723\_OUERAP\Fig2-17\_WaterTreatSawmillCompress.mxd Printed by: NicoleRockentine

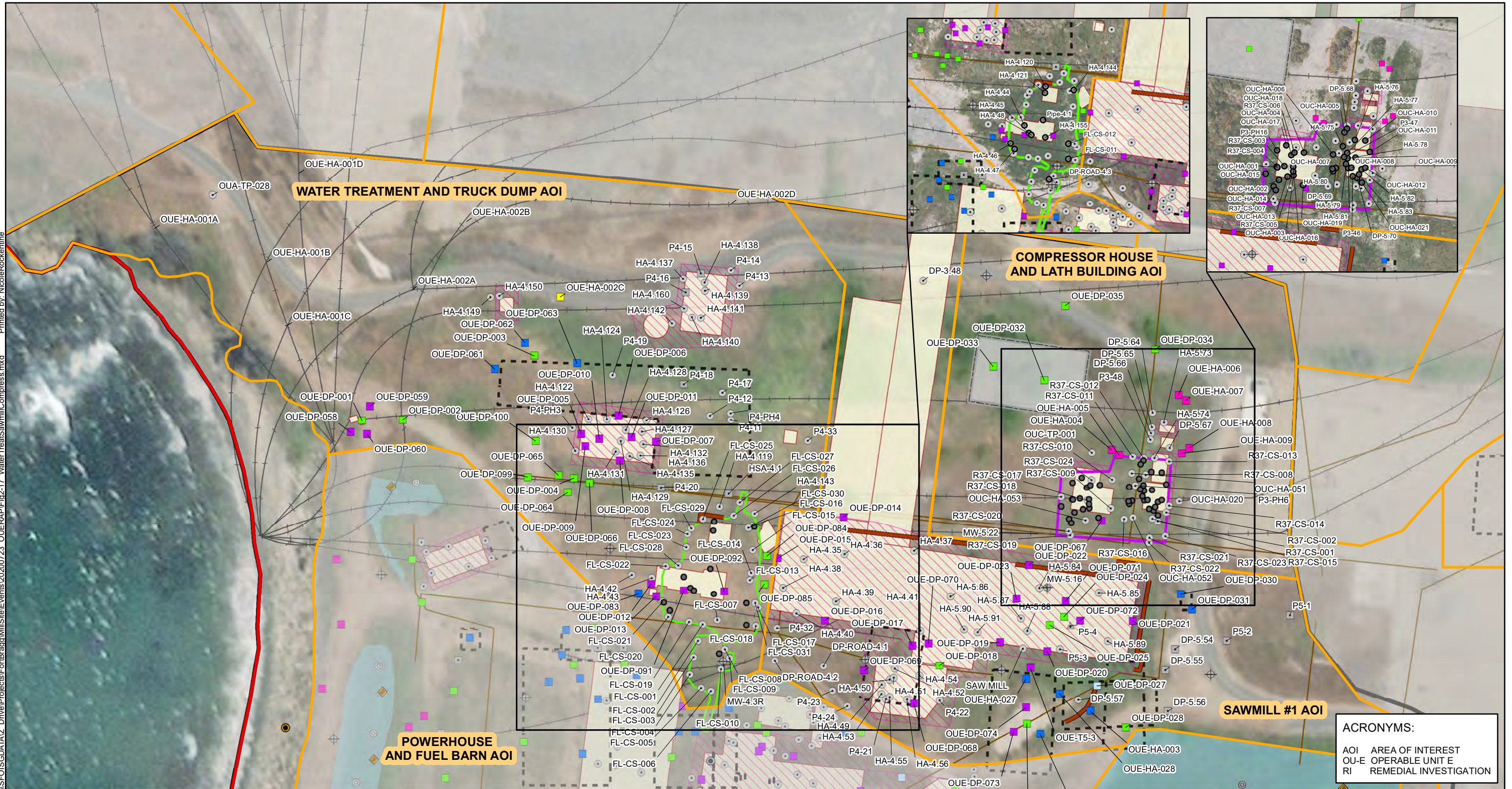

**ACRONYMS:**  
 AOI AREA OF INTEREST  
 OUE OPERABLE UNIT E  
 RI REMEDIAL INVESTIGATION

**Legend**

**Historical Sample Locations**

- Soil
- ▲ Groundwater
- Soil & Groundwater
- ◆ Sediment
- Sediment/Surface Water
- Surface Water
- ⊕ Monitoring Well
- ⊕ Abandoned Monitoring Well
- Excavated Sample Locations

**RI Sample Locations**

- Surface And Subsurface Soil
- Surface And/Or Subsurface Soil And Groundwater Grab
- Subsurface Soil Sample Only
- Discrete Soil Sample For Composite
- Groundwater Only
- Surface Soil Sample Only
- ◆ Sediment
- Surface Water

- Site Boundary
- Other Operable Units/AOIs
- OU-E Boundary
- AOI Boundary
- Former Structure
- Former Industrial Use (Approximate Location)

- Former Structure-Foundation Intact
- Pond
- Compressor House Excavation Boundary
- Fuel Line Excavation Boundary
- Capped Areas

- Plant Drain System Line
- Former Rail Lines
- Retaining Wall

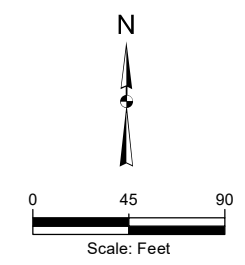

**Kennedy/Jenks Consultants**

Former Georgia-Pacific Wood Products Facility  
 Fort Bragg, California

**Water Treatment and Truck Dump, Compressor House and Lath Building, and Sawmill #1 AOIs – Soil, Sediment and Surface Water Sampling Locations**

1665018\*20

**Figure 2-17**

**NOTES:**

1. ARSENIC CONCENTRATIONS ARE SCREENED AGAINST BACKGROUND CONCENTRATION OF 10 mg/kg FOR SEDIMENT.
2. THE ECOLOGICAL PSL FOR ARSENIC IN SEDIMENT (9.76 mg/kg) IS APPROXIMATELY EQUAL TO THE BACKGROUND VALUE FOR ARSENIC IN SOIL (10 mg/kg) WHICH WAS SELECTED AS THE PSL FOR HUMAN HEALTH.
3. DATA FOR EXCAVATED SAMPLES ARE NOT PRESENTED.
4. DEPTHS PRESENTED AS FEET BELOW CURRENT SURFACE.
5. SAMPLED DEPTH INTERVAL(S) ARE INDICATED IN PARENTHESES BELOW THE LOCATION ID AS "S", "I" or "D". THE SCREENING RESULT FOR EACH LOCATION IS BASED ON THE HIGHEST SCREENING LEVEL EXCEEDANCE OF ALL SAMPLES COLLECTED AT THE LOCATION.
6. RESULTS IN BRACKETS ARE FROM A DUPLICATE SAMPLE COLLECTED AT THE SAME LOCATION AS THE PARENT SAMPLE.

**ABBREVIATIONS:**

AOC AREAS OF CONCERN  
 AOI AREA OF INTEREST  
 AST ABOVEGROUND STORAGE TANK  
 D ONE OR MORE SOIL SAMPLES COLLECTED FROM DEEP INTERVAL (>10 ft bss)  
 ft bss FEET BELOW SEDIMENT SURFACE  
 I ONE OR MORE SOIL SAMPLES COLLECTED FROM INTERMEDIATE INTERVAL (>2-10 ft bss)  
 mg/kg MILLIGRAMS PER KILOGRAM  
 OU-E OPERABLE UNIT E  
 S ONE OR MORE SOIL SAMPLES COLLECTED FROM SHALLOW INTERVAL (0-2 ft bss)  
 TEC THRESHOLD EFFECTS CONCENTRATION

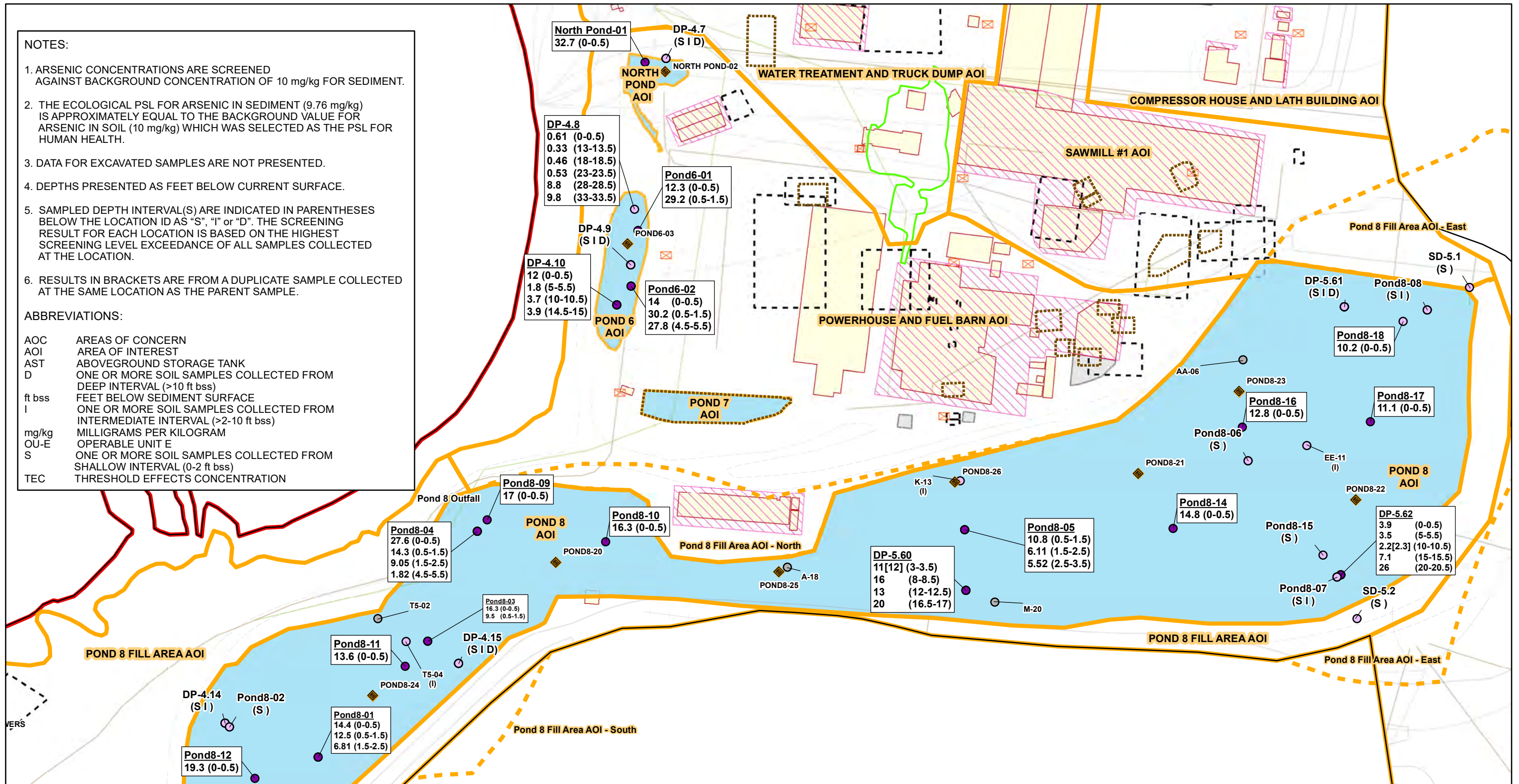

- Legend**
- Not Analyzed
  - Detected ≤ Background (10 mg/kg)
  - Detected > Background (10 mg/kg)
  - ▭ Site Boundary
  - ▭ OUE Boundary
  - ▭ AOI Boundary
  - ◆ 2019 Sediment Sample
  - ▭ Newly Identified Pond 8 Fill Area AOIs
  - ▭ Existing Structure
  - ▭ Former Structure
  - ▭ Former Structure - Foundation Intact
  - ▭ Pond
  - ▭ Fuel Line
  - ▭ Excavation Boundary
  - ▭ Approximate Cap Boundaries
  - ▭ Former Industrial Use (Approximate Location)
  - ▭ Former Transformer Location (Approximate)
  - ▭ Areas Excavated Fall 2017
  - ▭ Plant Drain System Line
  - ▭ Sanitary Sewer Line
  - ▭ Unpaved Roadway
  - ▭ Paved Roadway
  - ▭ Former Rail Lines

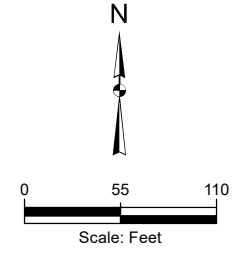
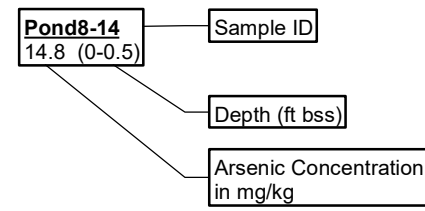

**Kennedy/Jenks Consultants**  
 Former Georgia-Pacific Wood Products Facility  
 Fort Bragg, California

**Arsenic Concentrations in Sediment – Ponds 6, 7, 8 and North Pond**



I:\SFOZ\_Drive\Projects\FortBragg\MillSiteEvents\20200723\_OUERAP\Fig2-19\_DioxinTEQSediment.mxd Printed by: NicoleRockentine

**NOTES:**

- 2,3,7,8-TCDD TEQ (HUMAN/MAMMAL) CONCENTRATIONS ARE SCREENED AGAINST DRAFT SITE SPECIFIC CLEANUP GOAL OF 53 pg/g FOR SEDIMENT.
- DATA FOR EXCAVATED SAMPLES ARE NOT PRESENTED.
- DEPTHS PRESENTED AS FEET BELOW CURRENT SURFACE.
- SAMPLED DEPTH INTERVAL(S) ARE INDICATED IN PARENTHESES BELOW THE LOCATION ID AS "S", "I" or "D". THE SCREENING RESULT FOR EACH LOCATION IS BASED ON THE HIGHEST SCREENING LEVEL EXCEEDANCE OF ALL SAMPLES COLLECTED AT THE LOCATION.

**ABBREVIATIONS:**

AOI AREA OF INTEREST  
 AST ABOVEGROUND STORAGE TANK  
 CHHSLr CALIFORNIA HUMAN HEALTH SCREENING LEVEL (RESIDENTIAL)  
 D ONE OR MORE SOIL SAMPLES COLLECTED FROM DEEP INTERVAL (>10 ft bss)  
 ft bss FEET BELOW SEDIMENT SURFACE  
 I ONE OR MORE SOIL SAMPLES COLLECTED FROM INTERMEDIATE INTERVAL (>2-10 ft bss)  
 OU-E OPERABLE UNIT E  
 pg/g PICOGRAMS PER GRAM  
 S ONE OR MORE SOIL SAMPLES COLLECTED FROM SHALLOW INTERVAL (0-2 ft bss)  
 TCDD TETRACHLORODIBENZO- P- DIOXIN  
 TEQ TOXIC EQUIVALENT

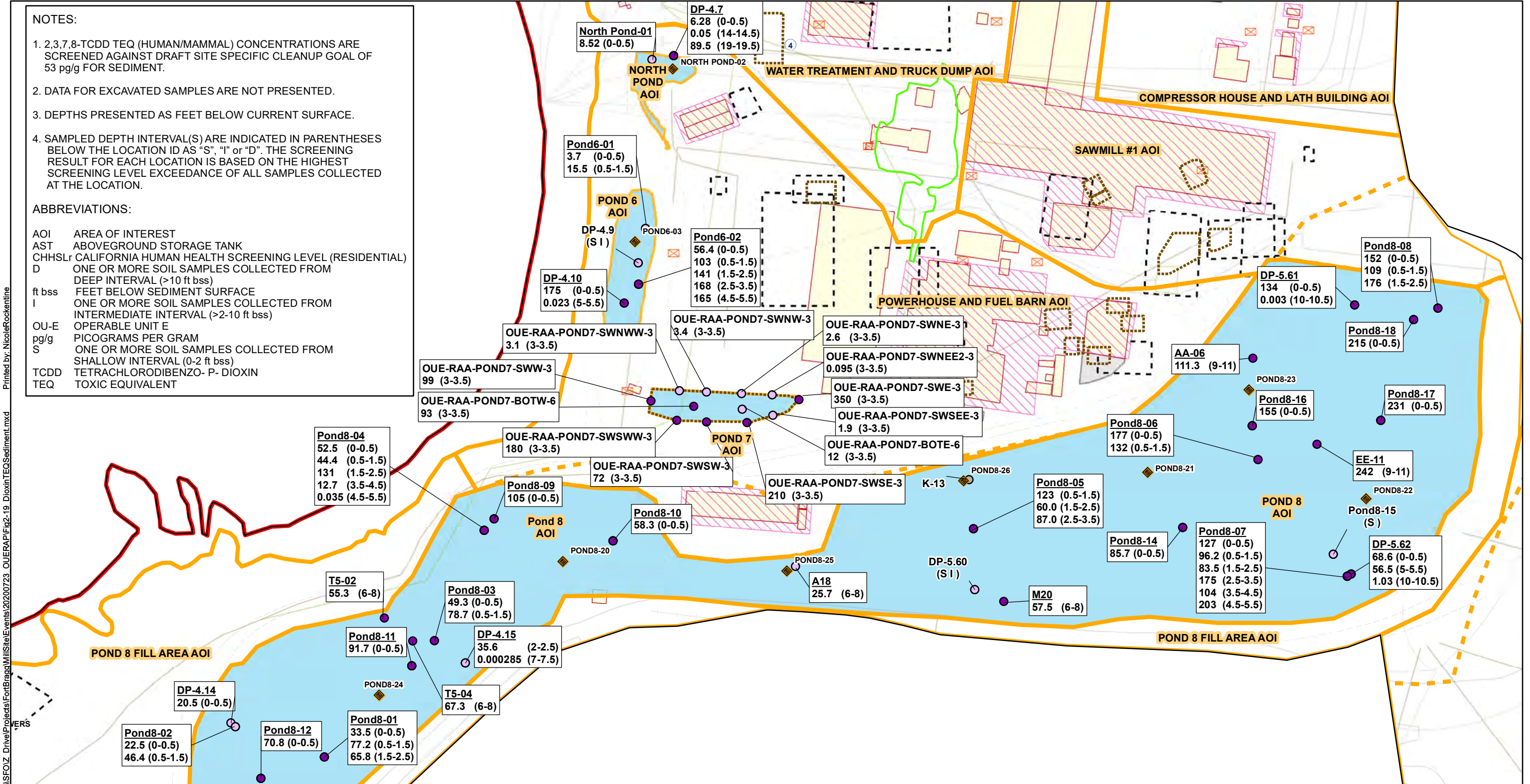

- Legend**
- Not Analyzed
  - Detected ≤ 53 pg/g
  - Detected > 53 pg/g
  - ▭ Site Boundary
  - ▭ OUE Boundary
  - ▭ AOI Boundary
  - ◆ 2019 Sediment Sample

- ▭ Newly Identified Pond 8 Fill Area AOIs
- ▭ Existing Structure
- ▭ Former Structure
- ▭ Former Structure - Foundation Intact
- ▭ Pond

- ▭ Fuel Line
- ▭ Excavation Boundary
- ▭ Approximate Cap Boundaries
- ▭ Former Industrial Use (Approximate Location)
- ▭ Former Transformer Location (Approximate)
- ▭ Areas Excavated Fall 2017

- ▭ Plant Drain System Line
- ▭ Sanitary Sewer Line
- ▭ Unpaved Roadway
- ▭ Paved Roadway
- ▭ Former Rail Lines

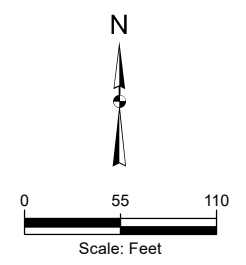
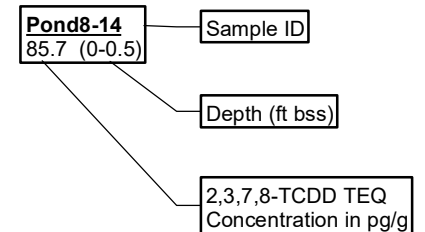

**Kennedy/Jenks Consultants**  
 Former Georgia-Pacific Wood Products Facility  
 Fort Bragg, California

**Dioxin (2,3,7,8-TCDD) TEQ Concentrations in Sediment – Ponds 6, 7, 8 and North Pond**

1665018\*20  
**Figure 2-19**

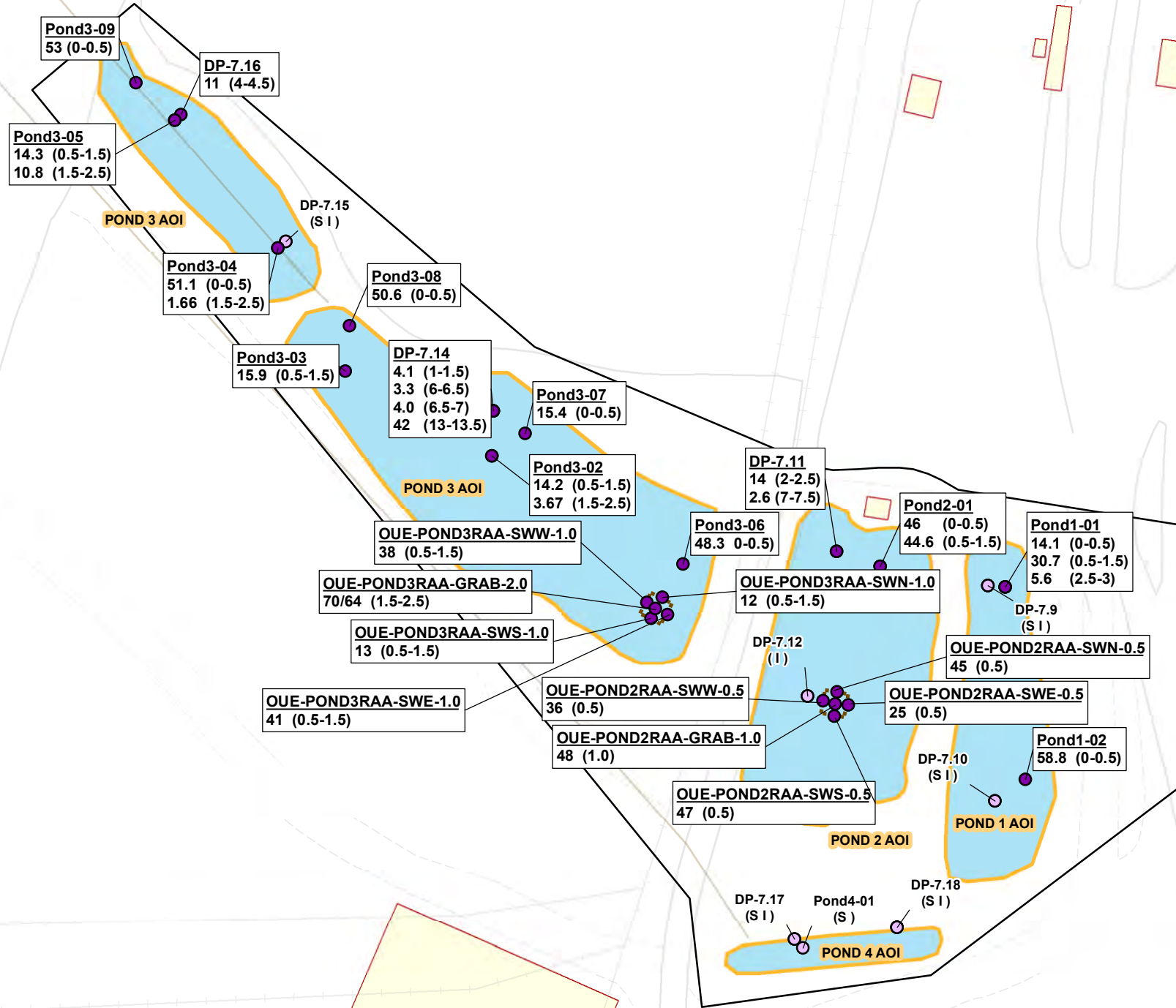

**NOTES:**

1. ARSENIC CONCENTRATIONS ARE SCREENED AGAINST BACKGROUND CONCENTRATION OF 10 mg/kg FOR SEDIMENT.
2. THE ECOLOGICAL PSL FOR ARSENIC IN SEDIMENT (9.76 mg/kg) IS APPROXIMATELY EQUAL TO THE BACKGROUND VALUE FOR ARSENIC IN SOIL (10 mg/kg) WHICH WAS SELECTED AS THE PSL FOR HUMAN HEALTH.
3. DATA FOR EXCAVATED SAMPLES ARE NOT PRESENTED.
4. DEPTHS PRESENTED AS FEET BELOW CURRENT SURFACE.
5. SAMPLED DEPTH INTERVAL(S) ARE INDICATED IN PARENTHESES BELOW THE LOCATION ID AS "S", "I" OR "D". THE SCREENING RESULT FOR EACH LOCATION IS BASED ON THE HIGHEST SCREENING LEVEL EXCEEDANCE OF ALL SAMPLES COLLECTED AT THE LOCATION.

**ABBREVIATIONS:**

AOI	AREA OF INTEREST
D	ONE OR MORE SOIL SAMPLES COLLECTED FROM DEEP INTERVAL (>10 ft bss)
ft bss	FEET BELOW SEDIMENT SURFACE
I	ONE OR MORE SOIL SAMPLES COLLECTED FROM INTERMEDIATE INTERVAL (>2-10 ft bss)
mg/kg	MILLIGRAM PER KILOGRAM
OU-E	OPERABLE UNIT E
S	ONE OR MORE SOIL SAMPLES COLLECTED FROM SHALLOW INTERVAL (0-2 ft bss)
TEC	THRESHOLD EFFECTS CONCENTRATION

**Legend**

- Detected ≤ Background (10 mg/kg)
- Detected > Background (10 mg/kg)
- AOI Boundary
- Existing Structure
- Former Structure
- OUE Boundary
- Pond
- Areas Excavated Fall 2017
- Plant Drain System Line
- Sanitary Sewer Line
- Unpaved Roadway
- Paved Roadway
- Former Rail Lines

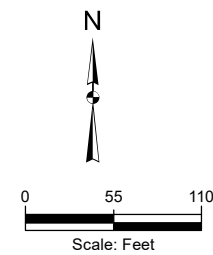
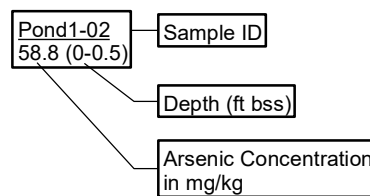

**Kennedy/Jenks Consultants**

Former Georgia-Pacific Wood Products Facility  
Fort Bragg, California

**Arsenic Concentrations in Sediment – Southern Ponds**

1665018\*20

**Figure 2-20**

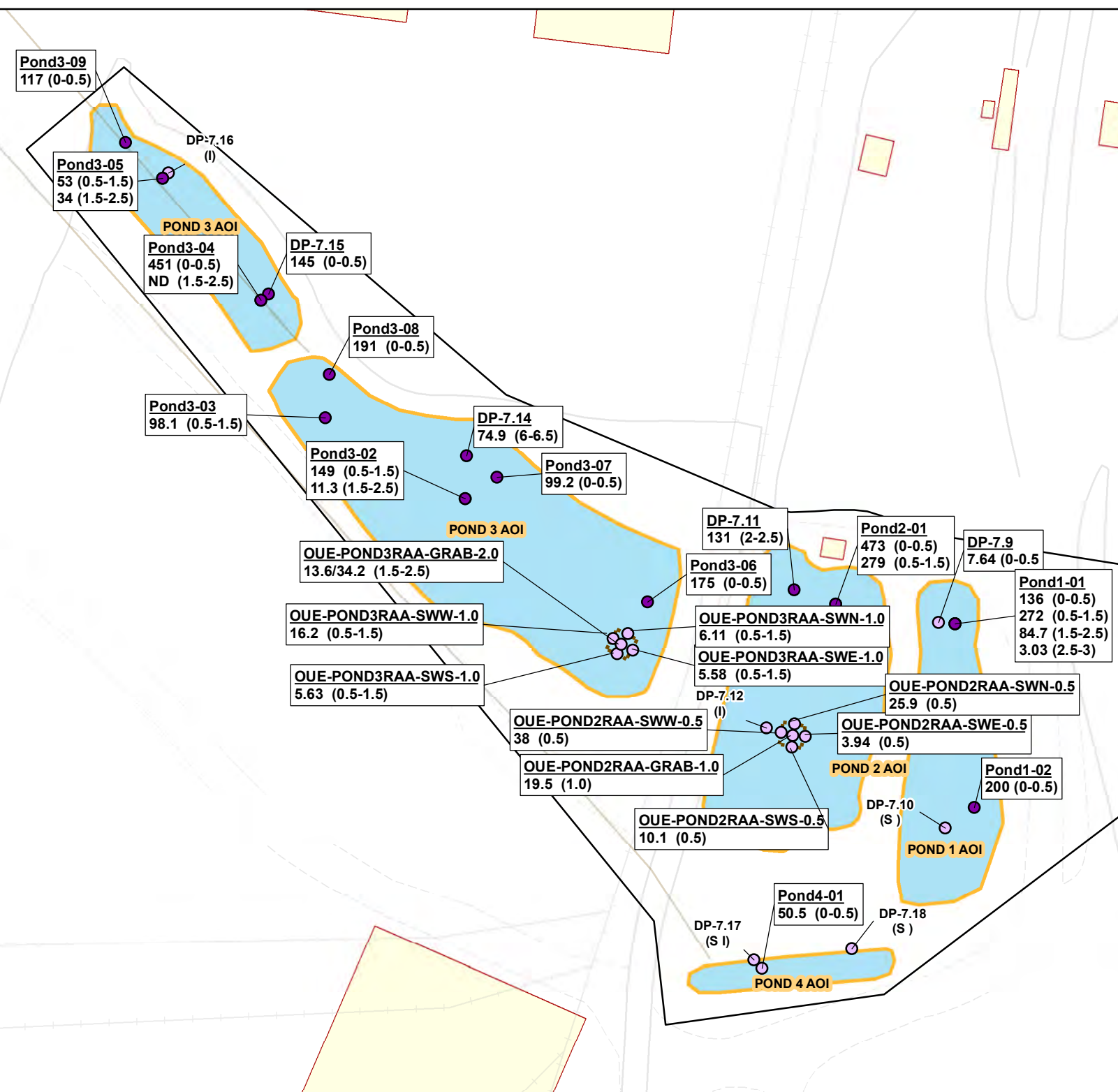

**NOTES:**

- 2,3,7,8-TCDD TEQ (HUMAN/MAMMAL) CONCENTRATIONS ARE SCREENED AGAINST DRAFT SITE SPECIFIC CLEANUP GOAL OF 53 pg/g FOR SEDIMENT.
- DATA FOR EXCAVATED SAMPLES ARE NOT PRESENTED.
- DEPTHS PRESENTED AS FEET BELOW CURRENT SURFACE.
- SAMPLED DEPTH INTERVAL(S) ARE INDICATED IN PARENTHESES BELOW THE LOCATION ID AS "S", "I" or "D". THE SCREENING RESULT FOR EACH LOCATION IS BASED ON THE HIGHEST SCREENING LEVEL EXCEEDANCE OF ALL SAMPLES COLLECTED AT THE LOCATION.

**ABBREVIATIONS:**

AOI	AREA OF INTEREST
AST	ABOVEGROUND STORAGE TANK
CHHSLr	CALIFORNIA HUMAN HEALTH SCREENING LEVEL (RESIDENTIAL)
D	ONE OR MORE SOIL SAMPLES COLLECTED FROM DEEP INTERVAL (>10 ft bss)
ft bss	FEET BELOW SEDIMENT SURFACE
I	ONE OR MORE SOIL SAMPLES COLLECTED FROM INTERMEDIATE INTERVAL (>2-10 ft bss)
pg/g	PICOGRAMS PER GRAM
OU-E	OPERABLE UNIT E
S	ONE OR MORE SOIL SAMPLES COLLECTED FROM SHALLOW INTERVAL (0-2 ft bss)
TCDD	TETRACHLORODIBENZO- P- DIOXIN
TEQ	TOXIC EQUIVALENT

**Legend**

- Detected ≤ 53 pg/g
- Detected > 53 pg/g

<span style="border: 1px solid orange; display: inline-block; width: 15px; height: 10px;"></span> AOI Boundary	<span style="border-bottom: 1px solid brown; width: 20px; display: inline-block;"></span> Plant Drain System Line
<span style="background-color: #f4b084; border: 1px solid black; display: inline-block; width: 15px; height: 10px;"></span> Existing Structure	<span style="border-bottom: 1px solid green; width: 20px; display: inline-block;"></span> Sanitary Sewer Line
<span style="background-color: #fff9c4; border: 1px solid black; display: inline-block; width: 15px; height: 10px;"></span> Former Structure	<span style="border-bottom: 1px dashed gray; width: 20px; display: inline-block;"></span> Unpaved Roadway
<span style="border: 2px solid black; display: inline-block; width: 15px; height: 10px;"></span> OUE Boundary	<span style="border-bottom: 1px solid gray; width: 20px; display: inline-block;"></span> Paved Roadway
<span style="background-color: #add8e6; border: 1px solid black; display: inline-block; width: 15px; height: 10px;"></span> Pond	<span style="border-bottom: 1px dashed gray; width: 20px; display: inline-block;"></span> Former Rail Lines
<span style="border: 2px dashed orange; display: inline-block; width: 15px; height: 10px;"></span> Areas Excavated Fall 2017	

Pond1-02 200 (0-0.5)	Sample ID
200 (0-0.5)	Depth (ft bss)
200 (0-0.5)	2,3,7,8-TCDD TEQ Concentration in pg/g

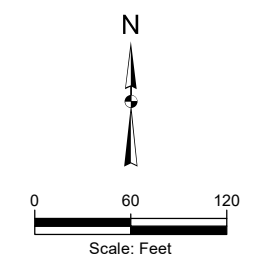

**Kennedy/Jenks Consultants**  
Former Georgia-Pacific Wood Products Facility  
Fort Bragg, California

**Dioxin (2,3,7,8-TCDD) TEQ Concentrations in Sediment – Southern Ponds**

1665018\*20  
**Figure 2-21**

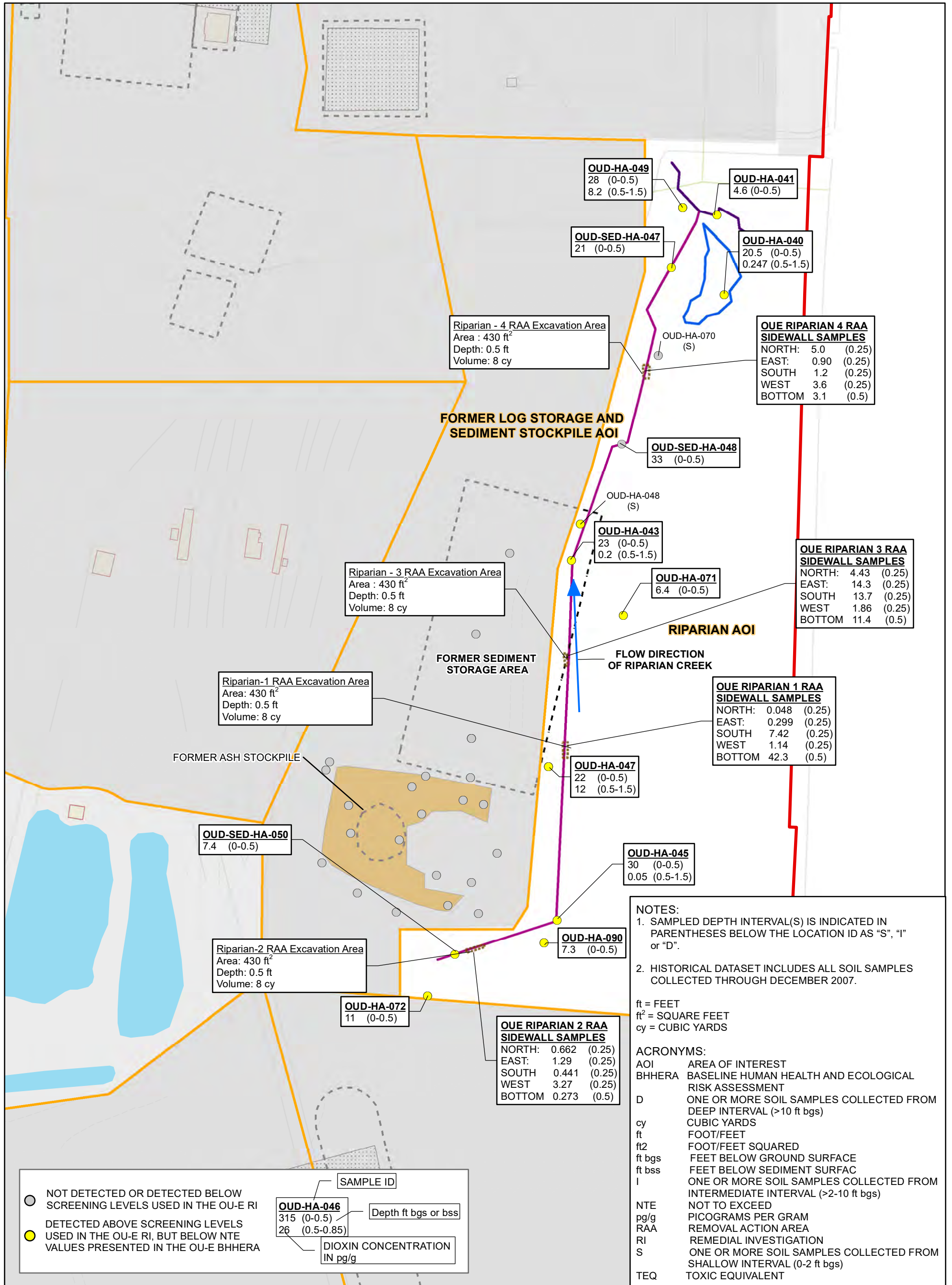

**Kennedy/Jenks Consultants**

Former Georgia-Pacific Wood Products Facility  
 Fort Bragg, California

**Dioxin (2,3,7,8-TCDD) TEQ Concentrations in Sediment Riparian Areas**

\\SFOZ\_Drive\Projects\FortBragg\MillSite\Events\20200723\_OJERAP\Fig2-23\_BHHERA\_Ponds 6, 7, 8, North.mxd Printed by: NicoleRockentine



**Legend**

**Sample Locations**

- Porewater Analyses
- PAH and Black Carbon Analyses

● Arsenic speciation

SITE BOUNDARY

OU-E BOUNDARY

POND

AREAS EXCAVATED FALL 2017

NOTE:  
TOTAL ORGANIC CARBON, GRAIN SIZE, pH,  
DISSOLVED OXYGEN, TEMPERATURE AND  
OXIDATION/REDUCTION POTENTIAL WAS  
COLLECTED FROM ALL SAMPLING LOCATIONS.

ACRONYM:  
OU-E OPERABLE UNIT E

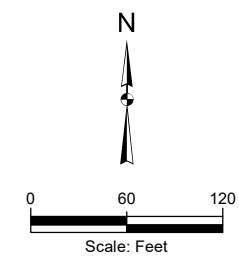

**Kennedy/Jenks Consultants**

Former Georgia-Pacific Wood Products Facility  
Fort Bragg, California

**BHHERA Sampling Locations –  
Ponds 6, 7, 8 and North Pond**

1665018\*20

**Figure 2-23**

\\SFOZ\_Drive\Projects\FortBragg\MIISite\Events\20200723\_OJERAP\Fig2-24\_BHHERA\_Ponds\_9.mxd Printed by: NicoleRockentine



**Legend**

**Sample Locations**

● Porewater Analyses

▭ SITE BOUNDARY

▭ OU-E BOUNDARY

▭ POND

NOTES:  
TOTAL ORGANIC CARBON, GRAIN SIZE, pH,  
DISSOLVED OXYGEN, TEMPERATURE AND  
OXIDATION/REDUCTION POTENTIAL WAS  
COLLECTED FROM ALL SAMPLING LOCATIONS.

THE LOCATION OF POND 9-01 IS APPROXIMATE

ACRONYM:  
OU-E OPERABLE UNIT E

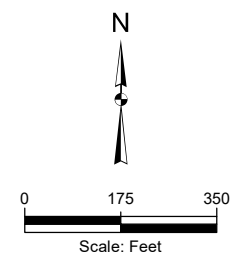

**Kennedy/Jenks Consultants**

Former Georgia-Pacific Wood Products Facility  
Fort Bragg, California

**BHHERA Sampling Locations –  
Ponds 5 and 9**

1665018\*20

**Figure 2-24**

\\SFOZ\_Drive\Projects\FortBragg\MillSite\Events\2020\723\_OUERAP\Fig2-25\_BHHERA\_SouthernPonds.mxd Printed by: NicoleRockentine



**Legend**

**Sample Locations**

- Porewater Analyses
- PAH and Black Carbon Analyses

● Arsenic speciation

OU-E BOUNDARY

POND

AREAS EXCAVATED FALL 2017

NOTE:  
TOTAL ORGANIC CARBON, GRAIN SIZE, pH,  
DISSOLVED OXYGEN, TEMPERATURE AND  
OXIDATION/REDUCTION POTENTIAL WAS  
COLLECTED FROM ALL SAMPLING LOCATIONS.

ACRONYM:  
OU-E OPERABLE UNIT E

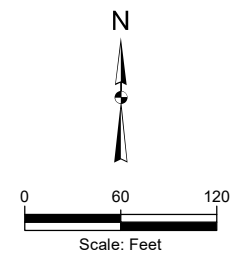

**Kennedy/Jenks Consultants**

Former Georgia-Pacific Wood Products Facility  
Fort Bragg, California

**BHHERA Sampling Locations –  
Southern Ponds**

1665018\*20

**Figure 2-25**



**Legend**

**Sample Locations**

- Porewater Analyses
- PAH and Black Carbon Analyses

- Site Boundary
- Pond
- Structure
- Riparian Area
- Riparian Wetland
- Seasonal Wetland
- Ditch
- Areas Excavated Fall 2017

NOTE:  
TOTAL ORGANIC CARBON, GRAIN SIZE, pH,  
DISSOLVED OXYGEN, TEMPERATURE AND  
OXIDATION/REDUCTION POTENTIAL WAS  
COLLECTED FROM ALL SAMPLING LOCATIONS.

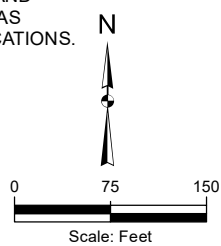

**Kennedy/Jenks Consultants**

Former Georgia-Pacific Wood Products Facility  
Fort Bragg, California

**BHHERA Sampling Locations –  
Riparian**



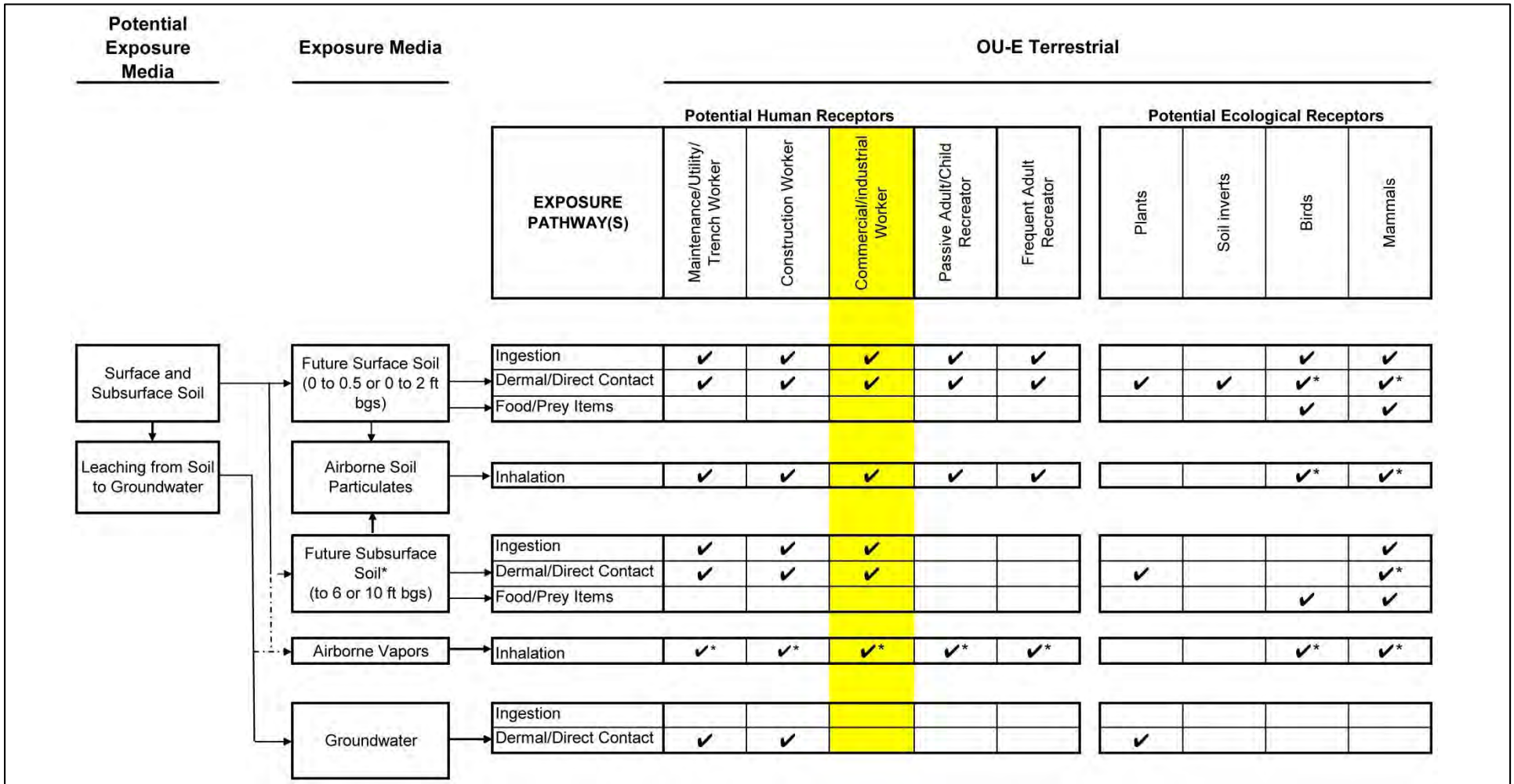

Notes:

— · → Potentially complete pathway if VOCs are identified as

✓ Potentially complete exposure pathwa VOC = volatile organic compounds

✓\* Potentially complete but likely insignificant pathway

COPC = chemical of potential concern

ft bgs = feet below ground surface

OU = operable unit

\* Note that where depth of groundwater is shallow, exposure depths will be limited to 2 feet below the groundwater table.

Additional receptor from those approved in the June 2008 *Site-Wide Risk Assessment Work Plan* (submitted by ARCADIS on behalf of Georgia-Pacific), included in order to assess the potential use of the site as a commercial property.

**Kennedy/Jenks Consultants**

Former Georgia-Pacific Wood Products Facility  
Fort Bragg, California

**Lowland Terrestrial Conceptual Site Model**

1665018\*20

**Figure 2-27**

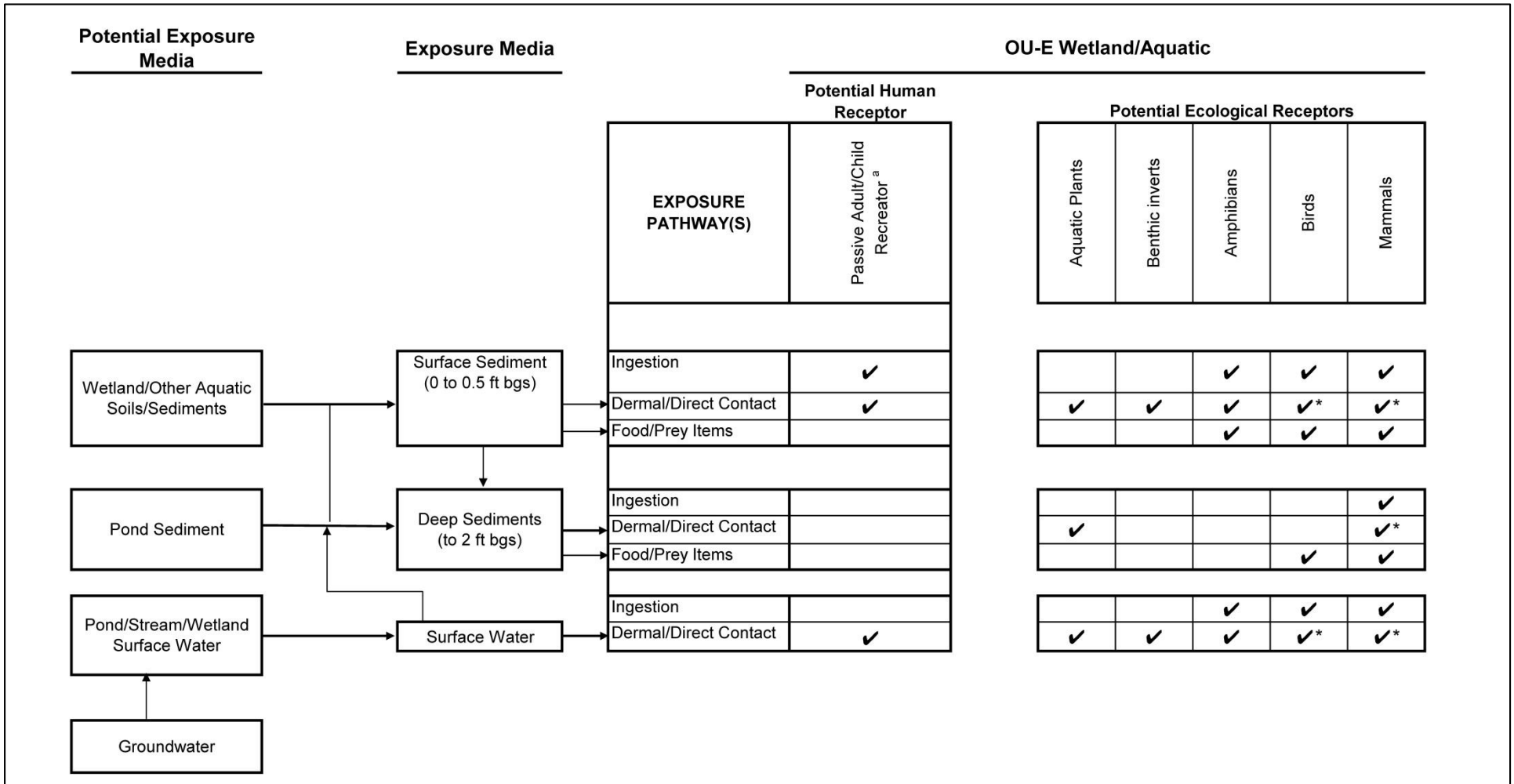

- Notes:
- ✓ Potentially complete exposure pathway
  - ✓\* Potentially complete but likely insignificant pathway

COPC = chemical of potential concern  
 ft bgs = feet below ground surface  
 OU = operable unit  
<sup>a</sup> Recreators are unlikely to be frequently exposed to surface water and sediment but this pathway will be quantitatively evaluated to be protective.

**Kennedy/Jenks Consultants**

Former Georgia-Pacific Wood Products Facility  
 Fort Bragg, California

**Aquatic Area Conceptual Site Model**

# Appendix A

---

## Administrative Record List

Appendix A: Administrative Record

**Operable Unit E Remedial Action Plan  
Former Georgia-Pacific Wood Products Facility  
Fort Bragg, California**

Date	Author	Receiver	Title of Document
1962	Union Lumber Company	--	Miscellaneous Site Maps of the Fort Bragg Sawmill (only partial copies of originals were available)
06/1982	California Department of Water Resources	Public	Mendocino County Coastal Ground Water Study. June.
10/1988	United States Environmental Protection Agency	Public	Guidance for Conducting Remedial Investigations and Feasibility Studies (RI/FS) under CERCLA. Report No. EPA/540/G-89/004.
1995	Department of Toxic Substances Control	Public	Remedial Action Plan Policy, DTSC Guidance Document No. EO-95-007-PP.
02/1995	Kennedy/Jenks Consultants	North Coast Regional Water Quality Control Board	Limited Soil and Groundwater Investigation Report. Prepared for Georgia-Pacific Sawmill Facility, Fort Bragg, California
04/01/1998	TRC Companies Inc.	Georgia-Pacific Corporation	Letter from Mr. Mohammad Bazargani, Project Manager, and Dr. Jonathan Scheiner, Senior Project Scientist, to Mr. Larry L. Lake, Environmental Site Coordinator, Georgia-Pacific Corporation, re: Report of Findings, Preliminary Investigation Demolition Support Services, Georgia-Pacific Fort Bragg Facility, Fort Bragg, California. Project No. 97-734
10/1994	U.S. Environmental Protection Agency (USEPA)	Public	How to Evaluate Alternative Cleanup Technologies for Underground Storage Tank Sites: A Guide for Corrective Action Plan Reviewers. EPA 510-B-94-003. Available online at: <a href="http://www.epa.gov/swerust1/pubs/tum_ch5.pdf">http://www.epa.gov/swerust1/pubs/tum_ch5.pdf</a> .
04/01/1998	TRC Companies, Inc.	Georgia-Pacific Corporation	Letter from Mr. Mohammad Bazargani, Project Manager, and Dr. Jonathan Scheiner, Senior Project Scientist, to Mr. Larry L. Lake, Environmental Site Coordinator, Georgia-Pacific Corporation, re: Report of Findings, Preliminary Investigation Demolition Support Services, Georgia-Pacific Fort Bragg Facility, Fort Bragg, California. Project No. 97 734.
06/13/2002	California Coastal Commission	Public	Statewide Interpretive Guidelines. Revised June 13, 2000. California Department of Water Resources. 1982. Mendocino County Coastal Ground Water Study.
02/2003	Hygenics Environmental Services	North Coast Regional Water Quality Control Board	Asbestos and Lead Based Paint Inspection Report, Georgia Pacific Site, 90 West Redwood Avenue, Fort Bragg, California
03/2003	TRC Companies Inc.	North Coast Regional Water Quality Control Board	Archaeological Survey of the Georgia Pacific Lumber Mill Fort Bragg, California
03/2004	TRC Companies Inc.	North Coast Regional Water Quality Control Board	Phase I Environmental Site Assessment, Georgia-Pacific California Wood Products Manufacturing Division, 90 West Redwood Avenue, Fort Bragg, California
05/14/2004	TRC Companies Inc.	North Coast Regional Water Quality Control Board	Phase II Environmental Site Assessment, Georgia-Pacific, 90 West Redwood Avenue, Fort Bragg, California
06/2004	BACE Geotechnical	North Coast Regional Water Quality Control Board	Engineering Geologic Reconnaissance Report, Planned Blufftop Access Trail, Georgia-Pacific Property, Fort Bragg, California
10/2004	TRC Companies Inc.	North Coast Regional Water Quality Control Board	Additional Site Assessment Report, Georgia Pacific Former Sawmill Site, 90 West Redwood Avenue, Fort Bragg, California
11/03/2004	TRC Companies Inc.	North Coast Regional Water Quality Control Board	Letter from Mr. Mohammad Bazargani, P.E., Senior Associate, and Mr. Steve Kemnitz, Project Scientist, to Mr. Craig Hunt, California Regional Water Quality Control Board, North Coast Region, re: Groundwater Monitoring Report, Third Quarter 2004, Georgia Pacific Former Sawmill Site, 90 West Redwood Avenue, Fort Bragg, California. Project No. 41-0419-13
01/2005	California Environmental Protection Agency	Public	Use of California Human Health Screening Levels (CHHSLs) in Evaluation of Contaminated Properties.
06/2005	Acton•Mickelson•Environmental, Inc.	North Coast Regional Water Quality Control Board	Work Plan for Additional Site Assessment, Georgia-Pacific California Wood Products Manufacturing Facility, 90 West Redwood Avenue, Fort Bragg, California.
5/6/2005	Acton•Mickelson•Environmental, Inc.	North Coast Regional Water Quality Control Board	Addendum #1 to Work Plan for Additional Site Assessment, Georgia-Pacific California Wood Products Manufacturing Facility, 90 West Redwood Avenue, Fort Bragg, California.
8/19/2005	Acton•Mickelson•Environmental, Inc.	North Coast Regional Water Quality Control Board	Addendum #2 to Work Plan for Additional Site Assessment, Georgia-Pacific California Wood Products Manufacturing Facility, 90 West Redwood Avenue, Fort Bragg, California.
02/2006	Blackburn Consulting, Inc.	North Coast Regional Water Quality Control Board	Letter from Mr. Rick Sowers, PE, CEG, Senior Project Manager, and Mr. Tom Blackburn, GE, Principal, to Mr. John Matthey, Acton•Mickelson•Environmental, Inc., re: Geotechnical Evaluation, Bearing Support for Heavy Equipment Loads, Georgia-Pacific Mill Site, Fort Bragg, California
07/2006	Acton•Mickelson•Environmental, Inc.	North Coast Regional Water Quality Control Board	Dioxin Sampling and Analysis Report, Georgia-Pacific California Wood Products Manufacturing Facility, 90 West Redwood Avenue, Fort Bragg, California

**Operable Unit E Remedial Action Plan  
Former Georgia-Pacific Wood Products Facility  
Fort Bragg, California**

Date	Author	Receiver	Title of Document
08/2006	Acton•Mickelson•Environmental, Inc.	North Coast Regional Water Quality Control Board	Data Transmittal Report, Georgia-Pacific California Wood Products Manufacturing Facility, 90 West Redwood Avenue, Fort Bragg, California
11/2005 (Species list updated 2007)	WRA Environmental Consultants (WRA)	Georgia-Pacific Corporation	Biological Assessment, Georgia Pacific Fort Bragg Sawmill Factory, Fort Bragg, Mendocino County, California. Prepared for Georgia Pacific, Atlanta, Georgia. WRA Environmental Consultants, Inc.
09/2006	Acton•Mickelson•Environmental, Inc.	North Coast Regional Water Quality Control Board	Soil and Water Sampling, Area Southwest of Planer #2, Former Georgia-Pacific California Wood Products Manufacturing Facility, Fort Bragg, California
09/22/2006	Department of Toxic Substances Control	Georgia-Pacific Corporation	Review of revised Shed Stockpile Characterization Data Memorandum
09/25/2006	Department of Toxic Substances Control	Georgia-Pacific Corporation	Receipt of Ash Pile Work Removal and Disposal Work Plan
12/2006	Blasland, Bouk & Lee, Inc.	Department of Toxic Substances Control	Current Conditions Report, Georgia-Pacific Wood Products Manufacturing Facility, Fort Bragg, California
03/2007	ARCADIS BBL	Department of Toxic Substances Control	Response to Agency Comments on the Current Conditions Report, Former Georgia-Pacific Wood Products Facility, Fort Bragg, California
04/2007	ARCADIS BBL	Department of Toxic Substances Control	Construction Completion Report for Foundation and Ash Pile Removal Projects, Former Georgia-Pacific Wood Products Facility, Fort Bragg, California. Prepared for Georgia-Pacific LLC. April.
12/2007 (Revised 05/2008)	ARCADIS BBL	Department of Toxic Substances Control	Preliminary Site Investigation Work Plan Operable Unit E – Onsite Ponds, Former Georgia-Pacific Wood Products Facility, Fort Bragg, California. Prepared for Georgia-Pacific, LLC. December. Revised May 2008.
06/2007	ARCADIS BBL	Department of Toxic Substances Control	Ex-Situ Bioremediation Pilot Study. Former Georgia-Pacific Wood Products Facility, Fort Bragg, California
08/2007	ARCADIS BBL	Department of Toxic Substances Control	Background Metals Report. Former Georgia-Pacific Wood Products Facility, Fort Bragg, California. Prepared for Georgia-Pacific LLC. Arcadis BBL, an Arcadis company. August.
09/2007	ARCADIS BBL	Department of Toxic Substances Control	Quality and Addurance Protection Plan, Former Georgia-Pacific Wood Products Facility, Fort Bragg, California
01/2008-08/2008	Johnson, P. and D. Heitmeyer	ARCADIS U.S., Inc.	Personal communications with Judith Nedoff, ARCADIS
05/2008	ARCADIS BBL	Department of Toxic Substances Control	Site-Wide Risk Assessment Work Plan, Former Georgia-Pacific Wood Products Facility, Fort Bragg, California
06/2008	ARCADIS U.S., Inc.	Department of Toxic Substances Control	Interim Action Remedial Action Plan, Former Georgia-Pacific Wood Products Facility, Fort Bragg, California
03/2008	ARCADIS U.S., Inc.	Department of Toxic Substances Control	Final Interim Action Remedial Action Plan and Feasibility Study, Former Georgia-Pacific Wood Products Facility, Fort Bragg, California. Prepared for Georgia-Pacific LLC. June.
05/2009	ARCADIS U.S., Inc.	Department of Toxic Substances Control	Data Summary Report, Operable Unit E Pond Sediment, Former Georgia-Pacific Wood Products Facility, Fort Bragg, California. Prepared for Georgia-Pacific LLC. May.
08/14/2009	Stantec Consulting Corporation	Craig Hunt, California Regional Water Quality Control Board, North Coast Region	Hunt, California Regional Water Quality Control Board, North Coast Region re: Work Plan for Additional Groundwater Investigation and Well Installation, 76 Service Station No. 2211, 225 North Main Street, Fort Bragg, California
09/2009	WRA Environmental Consultants	Department of Toxic Substances Control	Delineation of Potential Section 404 Jurisdictional Wetlands and Waters, Former Georgia-Pacific Wood Products Facility, Fort Bragg, Mendocino County, California. September.
04/2010	ARCADIS U.S., Inc.	Department of Toxic Substances Control	Interim Action Completion Reports, Operable Units C & E, Former Georgia-Pacific Wood Products Facility, Fort Bragg, California
05/2010	ARCADIS U.S., Inc.	Department of Toxic Substances Control	Site Investigation Work Plan, Operable Unit E – Upland, Former Georgia-Pacific Wood Products Facility, Fort Bragg, California. Prepared for Georgia-Pacific LLC. Arcadis U.S., Inc. May.
10/2010	ARCADIS U.S., Inc.	Department of Toxic Substances Control	Site Investigation Summary and Step-out Evaluation, Operable Unit E, Former Georgia-Pacific Wood Products Facility, Fort Bragg, California. Prepared for Georgia-Pacific LLC. October.
4/2010	ARCADIS U.S., Inc.	Department of Toxic Substances Control	Letter from Bridgette DeShields, ARCADIS, to Thomas Lanphar, DTSC, re: Site-Specific TPH Leaching Evaluation. Prepared for Georgia-Pacific LLC. April 13.

**Operable Unit E Remedial Action Plan  
Former Georgia-Pacific Wood Products Facility  
Fort Bragg, California**

Date	Author	Receiver	Title of Document
05/2010	ARCADIS U.S., Inc.	Department of Toxic Substances Control	Site Investigation Work Plan, Operable Unit E – Upland, Former Georgia-Pacific Wood Products Facility, Fort Bragg, California.
10/2010	ARCADIS U.S., Inc.	Department of Toxic Substances Control	Site Investigation Summary and Step-out Evaluation, Operable Unit E, Former Georgia-Pacific Wood Products Facility, Fort Bragg, California.
2011	U.S. Environmental Protection Agency (USEPA)	Public	ProUCL Version 4.1.00. U.S. Environmental Protection Agency. Available online at <a href="http://www.epa.gov/esd/tsc/software.htm">http://www.epa.gov/esd/tsc/software.htm</a>
40604	ARCADIS U.S., Inc.	Department of Toxic Substances Control	Operable Unit E Upland – Site Investigation Sampling Summary, Former Georgia-Pacific Wood Products Facility, Fort Bragg, California.
2011	City of Fort Bragg	Public	Mill Site Specific Plan.
02/2011	ARCADIS U.S., Inc.	Department of Toxic Substances Control	Remedial Investigation Operable Units C and D, Former Georgia-Pacific Wood Products Facility, Fort Bragg, California
04/2011	ARCADIS U.S., Inc.	Department of Toxic Substances Control	Environmentally Sensitive Habitat Areas Delineation Report, Former Georgia-Pacific Wood Products Facility, Fort Bragg, California. Prepared for Georgia-Pacific LLC. April.
02/2011	ARCADIS U.S., Inc.	Department of Toxic Substances Control	Data Summary Report – Additional Investigation Pond 8 Sediment, Former Georgia-Pacific Wood Products Facility, Fort Bragg, California. Prepared for Georgia-Pacific LLC. Arcadis U.S., Inc. April. Revised February 2011.
06/2011	ARCADIS U.S., Inc.	Department of Toxic Substances Control	Mill Pond Complex Restoration Draft Conceptual Design, Former Georgia-Pacific Wood Products Facility, Fort Bragg, California. Prepared for Georgia-Pacific LLC, June.
03/2011	ARCADIS U.S., Inc.	Department of Toxic Substances Control	Operable Unit E Upland – Site Investigation Sampling Summary, Former Georgia-Pacific Wood Products Facility, Fort Bragg, California. Prepared for Georgia-Pacific LLC. Arcadis U.S., Inc. March 2.
01/2012	ARCADIS U.S., Inc.	Department of Toxic Substances Control	Feasibility Study, Operable Units C and D, Former Georgia-Pacific Wood Products Facility, Fort Bragg, California. Prepared for Georgia-Pacific LLC, January.
12/2012	ARCADIS U.S., Inc.	Department of Toxic Substances Control	Mill Pond (Pond 8) Geotechnical and Chemical Characterization Results, Former Georgia-Pacific Wood Products Facility, Fort Bragg, California. Prepared for Georgia-Pacific LLC. December.
01/2013	ARCADIS U.S., Inc.	Department of Toxic Substances Control	Final Remedial Investigation Report Operable Unit E (RI Report), Former Georgia-Pacific Wood Products Facility, Fort Bragg, California. Prepared for Georgia-Pacific LLC. January.
02/2013	ARCADIS U.S., Inc.	Department of Toxic Substances Control	Revised Baseline Human Health and Ecological Risk Assessment (BHHERA) Work Plan – Operable Unit E (OU-E) Addendum, Former Georgia-Pacific Wood Products Facility, Fort Bragg, California. Prepared for Georgia-Pacific LLC. February.
11/2013	ARCADIS U.S., Inc.	Department of Toxic Substances Control	Comprehensive Monitoring Plan Update No. 6, Former Georgia-Pacific Wood Products Facility, 90 West Redwood Avenue, Fort Bragg, California. Prepared for Georgia-Pacific LLC. November 6.
11/26/2013	Department of Toxic Substances Control	Georgia-Pacific LLC	Letter from Mr. Thomas P. Lanphar, Senior Hazardous Scientist, Brownfields and Environmental Restoration Program, to Mr. Dave Massengill, Senior Director, Georgia-Pacific LLC, re: Comprehensive Monitoring Program Update Number 6, Dated November 6, 2013, Former Georgia-Pacific Former Wood Products Facility, Fort Bragg, California. November 26.
2/7/2013	Department of Toxic Substances Control	Georgia-Pacific Corporation	Letter from Tom to Dave, Re: Final Remedial Investigation Report – Operable Unit E, Dated January 2013, Former Georgia-Pacific Wood Products Facility, Fort Bragg, California. February 7.
03/2013	ARCADIS U.S., Inc.	Department of Toxic Substances Control	Monitored Natural Attenuation Technical Report, Former Georgia-Pacific Wood Products Facility, Fort Bragg, California
04/17/2013	Department of Toxic Substances Control	Georgia-Pacific Corporation	Monitored Natural Attenuation Technical Report, Dated March 7, 2013, Former Georgia-Pacific Wood Products Facility, Fort Bragg, California
06/25/2014	Department of Toxic Substances Control	ARCADIS U.S., Inc.	Identification of Presumptive Remedy Areas on Operable Unit E Georgia Pacific Former Sawmill Site, Fort Bragg. PCA: 11018. Site Code: 200402-00. June 25.
07/2014	ARCADIS U.S., Inc.	Department of Toxic Substances Control	Mill Site Dam Supplemental Site Investigation Work Plan, Former Georgia-Pacific Wood Products Facility, Fort Bragg, California. Prepared for Georgia-Pacific LLC. July.
08/2015	ARCADIS U.S., Inc.	Department of Toxic Substances Control	Baseline Human Health and Ecological Risk Assessment – Operable Unit E, Former Georgia-Pacific Wood Products Facility, Fort Bragg, California. Prepared for Georgia-Pacific LLC. August.

**Operable Unit E Remedial Action Plan  
Former Georgia-Pacific Wood Products Facility  
Fort Bragg, California**

Date	Author	Receiver	Title of Document
05/2016	ARCADIS U.S., Inc.	Department of Toxic Substances Control	Removal Action Work Plan Operable Unit E, Former Georgia-Pacific Wood Products Facility, Fort Bragg, California. Prepared for Georgia-Pacific LLC. May.
01/20/2016	Department of Toxic Substances Control	Georgia-Pacific LLC	Letter from Mr. Thomas P. Lanphar, Senior Environmental Scientist, Brownfields and Environmental Restoration Branch – Berkeley, to Mr. Dave Massengill, Senior Director, Georgia-Pacific LLC, re: Draft Operable Unit E Feasibility Study, Former Georgia-Pacific Wood Products Facility, Fort Bragg, California. January 20.
02/24/2016	Department of Toxic Substances Control	Mr. Dave Massengill, Senior Director, Georgia-Pacific LLC	Letter from Mr. Thomas P. Lanphar, Senior Environmental Scientist, Brownfields and Environmental Restoration Branch – Berkeley, to Mr. Dave Massengill, Senior Director, Georgia-Pacific LLC, re: Proposed Removal Action for Sites Within Operable Unit E Feasibility Study, Former Georgia-Pacific Wood Products Facility, Fort Bragg, California
10/13/2016	Department of Toxic Substances Control	Georgia-Pacific LLC	Letter from Mr. Thomas P. Lanphar, Senior Environmental Scientist, Brownfields and Environmental Restoration Program – Berkeley, to Mr. David G. Massengill, Senior Director, Georgia-Pacific LLC, re: Removal Action Work Plan, Operable Unit E, Former Georgia-Pacific Wood Products Facility, Fort Bragg, California. October 13.
03/07/2016	State of California	Public	California Health and Safety Code (HSC) 2016. Chapter 6.8, Section 25323.1. Available online at: <a href="http://www.leginfo.ca.gov/cgi-bin/displaycode?section=hsc&amp;group=25001-26000&amp;file=25310-25327">http://www.leginfo.ca.gov/cgi-bin/displaycode?section=hsc&amp;group=25001-26000&amp;file=25310-25327</a>
04/2016	Department of Toxic Substances Control	Public	Fact Sheet – Community Update: Proposed Removal Action Workplan for Operable Unit-E at the former Georgia-Pacific Mill Site
05/12/2016	Department of Toxic Substances Control	Public	Public Notice for the Proposed Removal Action Workplan for portions of the Former Georgia-Pacific Mill Site, Operable Unit E
05/2016	Department of Toxic Substances Control		Responsible Agency Checklist, Removal Action Workplan for Operable Unit E, Former Georgia-Pacific Wood Products Facility,
07/20/2016	City of Fort Bragg	Public	Addendum to the Final Subsequent Environmental Impact Report (SEIR Addendum) for the Fort Bragg Coastal Restoration and Trail Phase II Project
06/14/2017	Kennedy/Jenks Consultants	Department of Toxic Substances Control	Final OU C, OU-D, and OU-E Implementation Plan, Former Georgia-Pacific Wood Products Facility, Fort Bragg, California. June 14.
10/26/2017	Department of Toxic Substances Control	Georgia-Pacific LLC	Letter from Mr. Thomas P. Lanphar, to Mr. David G. Massengill, Senior Director, Georgia-Pacific LLC, re: Well Destruction Workplan, Former Georgia-Pacific Wood Products Facility, Fort Bragg, California. October 26.
01/31/2018	Kennedy/Jenks Consultants	Georgia-Pacific LLC	Wetland Establishment Area Annual Report and As-Built Conditions for Georgia-Pacific Fort Bragg Mill Site. January 31.
03/12/2018	Kennedy/Jenks Consultants	Department of Toxic Substances Control	Remedial Action Completion Report for Operable Units OU-C, OU-D, and OU-E, Former Georgia-Pacific Wood Products Facility, Fort Bragg, California. March 12.
06/15/2018	Kennedy/Jenks Consultants	Department of Toxic Substances Control	Final Remedial Action Completion Report for Operable Units OU C, OU-D, and OU-E, Former Georgia-Pacific Wood Products Facility, Fort Bragg, California. 15 June.
06/27/2018	Department of Toxic Substances Control	Georgia-Pacific LLC	Letter from Mr. Thomas P. Lanphar, to Mr. David G. Massengill, Senior Director, Georgia-Pacific LLC, re: Final Remedial Action Completion Report for Operable Units C, D, and E, Former Georgia-Pacific Wood Products Facility, Fort Bragg, California. June 27.
05/09/2018	Department of Toxic Substances Control	Public	Community Update on Cleanup Accomplishments, OUE – Feasibility Study. May 9.
12/2018	ESA	Georgia-Pacific LLC	Georgia Pacific Mill Site OU-E Mitigation Monitoring, Year 1 Report. December.
07/19/2019	Department of Toxic Substances Control	Georgia-Pacific LLC	Letter from Mr. Thomas P. Lanphar, to Mr. David G. Massengill, Senior Director, Georgia-Pacific LLC, re: Pond 6, North Pond, and Pond 8 Sediment Sampling Work Plan, Former Georgia-Pacific Wood Products Facility, Fort Bragg, California. July 19.
06/25/2019	Kennedy/Jenks Consultants	Department of Toxic Substances Control	Pond 6, North Pond, and Pond 8 Sediment Sampling Work Plan, Former Georgia-Pacific Wood Products Facility, Fort Bragg, California. June 25.
09/12/2019	Kennedy/Jenks Consultants	Department of Toxic Substances Control	Final Feasibility Study Operable Unit E, Former Georgia-Pacific Wood Products Facility, Fort Bragg, California. 12 September.

**Operable Unit E Remedial Action Plan  
Former Georgia-Pacific Wood Products Facility  
Fort Bragg, California**

Date	Author	Receiver	Title of Document
10/24/2019	Department of Toxic Substances Control	Georgia-Pacific LLC	Letter from Ms. Juliet Pettijohn, to Mr. David G. Massengill, Senior Director, Georgia-Pacific LLC, re: Georgia-Pacific, Operable Unit E Feasibility Study, Former Georgia-Pacific Wood Products Facility, Fort Bragg, California. 24 October.
01/2020	ESA	Georgia-Pacific LLC	Georgia Pacific Mill Site OU-E Mitigation Monitoring, Year 2 Report. January.
03/30/2020	Department of Toxic Substances Control	Georgia-Pacific LLC	Letter from Ms. Juliet Pettijohn, to Mr. David G. Massengill, Senior Director, Georgia-Pacific LLC, re: Site-Wide Groundwater Operation & Maintenance Plan, Former Georgia-Pacific Wood Products Facility, Fort Bragg, California. 30 March.
05/26/2020	Department of Toxic Substances Control	Georgia-Pacific LLC	Letter from Ms. Juliet Pettijohn, to Mr. David G. Massengill, Senior Director, Georgia-Pacific LLC, re: Pond 6, North Pond, and Pond 8 Sediment Sampling Report, Former Georgia-Pacific Wood Products Facility, Fort Bragg, California. 26 May.
06/30/2020	Department of Toxic Substances Control	Georgia-Pacific LLC	Email from Mr. Thomas P. Lanphar, to Mr. David G. Massengill, Georgia-Pacific LLC, Jeremie Maehr, Kennedy Jenks, and Rachel Morgan, Kennedy Jenks, re: Former Georgia-Pacific Wood Products Facility / Mendocino Railway - Fort Bragg – Well Destruction Work Plan, by Kennedy Jenks dated June 8, 2020 - GSU comments. 30 June.
03/23/2020	Kennedy/Jenks Consultants	Department of Toxic Substances Control	Operable Unit D and Operable Unit E, Groundwater Operation & Maintenance Plan, Former Georgia-Pacific Wood Products Facility, Fort Bragg, California. Prepared for Georgia-Pacific LLC. 23 March.
04/08/2020	Kennedy/Jenks Consultants	Department of Toxic Substances Control	Pond 6, North Pond, and Pond 8 Sediment Sampling Report, Former Georgia-Pacific Wood Products Facility, Fort Bragg, California. 8 April.
06/08/2020	Kennedy/Jenks Consultants	Department of Toxic Substances Control	Well Destruction Work Plan, Former Georgia-Pacific Wood Products Facility, Fort Bragg, California. 8 June.
undated	TRC Companies Inc.	The City of Fort Bragg	Phase II Determination of Significance Standing Structures Georgia Pacific Lumber Mill Fort Bragg, California. Draft Report.
undated	TRC Companies Inc.	The City of Fort Bragg	Site Specific Treatment Plan for Cultural Resources. Draft Report.



## Enclosure 4

---

Operable Unit E Draft Remedial Action Plan and Confirmation of  
No Further Action for Operable Unit E Soil and Ponds 5 and 9,  
Former Georgia-Pacific Wood Products Facility,  
Fort Bragg, California (DTSC 2020)



**Jared Blumenfeld**  
Secretary for  
Environmental Protection



## Department of Toxic Substances Control

Meredith Williams, Ph.D., Director  
700 Heinz Avenue  
Berkeley, California 94710-2721



**Gavin Newsom**  
Governor

December 8, 2020

Mr. David G. Massengill  
Senior Director  
Georgia-Pacific LLC  
133 Peachtree Street NE  
Atlanta, Georgia 30303  
[DGMassen@GAPAC.com](mailto:DGMassen@GAPAC.com)

OPERABLE UNIT E DRAFT REMEDIAL ACTION PLAN AND CONFIRMATION OF NO FURTHER ACTION FOR OPERABLE UNIT E SOIL AND PONDS 5 AND 9, FORMER GEORGIA-PACIFIC WOOD PRODUCTS FACILITY, FORT BRAGG, CALIFORNIA

Dear Mr. Massengill,

The Department of Toxic Substances Control (DTSC) has received the *Operable Unit - E (OU-E) draft Remedial Action Plan (RAP)* dated October 14, 2020. Although DTSC has initiated internal review of the RAP, DTSC will not begin the formal public review period until the City of Fort Bragg completes their draft Environmental Impact Report (EIR) for the Mill Pond Dam Repair Project scheduled for late 2021. Repair of Mill Pond Dam is a central element of the proposed containment remedial action for Pond 8 at the Former Mill Site. The City of Fort Bragg is the lead agency for implementing the California Environmental Quality Act (CEQA) for the project. As a Responsible Agency under CEQA, DTSC will provide input into the scope and preparation of the draft EIR and rely on a final EIR when considering approval of the OU-E RAP. DTSC will provide comments on the draft OU-E RAP next year (early 2021).

### **No Further Action for Ponds 5 and 9**

The draft OU-RAP recommends No Further Action (NFA) for the Pond 5 Area of Interest (AOI) and Pond 9 AOI. Sediment in Pond 5 and Pond 9 was evaluated in the Baseline Human Health and Ecological Risk Assessment (BHHERA). As described in the BHHERA, occasional adult recreator hazard indices (HIs) and excess lifetime cancer risks (ELCRs) for Pond 5 and Pond 9 are below 1 and  $1 \times 10^{-6}$  respectively, considering a 50 day per year exposure frequency. DTSC accepted this conclusion in the BHHERA when DTSC approved the BHHERA on August 20, 2015. As presented in the OU-E Feasibility Study (FS), dated September 12, 2019 (Section 2.2.6.2), Pond 5 AOI and Pond 9 AOI were not evaluated in the OU-E FS because the ELCRs for Pond 5 and

Dave Massengill  
December 8, 2020  
Page 2 of 3

Pond 9 are below the risk management threshold of  $1 \times 10^{-6}$ . DTSC again agreed with this conclusion and approved the OU-E FS on October 24, 2019. DTSC agrees with the recommendation of NFA in the draft OU-E RAP for the Pond 5 AOI and Pond 9 AOI. Because of the anticipated extended schedule for the OU-E RAP and in support for possible redevelopment of the Former Mill Site, DTSC approves NFA for the Pond 5 and Pond 9 AOIs. The draft OU-E RAP can be amended to reflect this approval.

### **No Further Action for OU-E Soil**

As presented in the Removal Action Completion Report (RACR) dated March 12, 2018, residual contaminant of concern (COC) concentrations at the Riparian Area AOI are below the residential screening criteria at each confirmation sample point; therefore, NFA was recommended for the Riparian Area AOI in the RACR. The Lowland Terrestrial Area of Concern (AOC) includes several AOIs: Water Treatment and Truck Dump AOI, Powerhouse and Fuel Barn AOI, Sawmill #1 AOI, and the Compressor House and Lath Building AOI. The Exposure Point Concentrations (EPCs) for soil in the Lowland Terrestrial AOC meet residential screening criteria, and therefore, the Lowland Terrestrial AOC was also recommended for NFA for soil in the RACR. DTSC approved the RACR and NFA for OU-E Lowland Terrestrial Soil AOC and Riparian AOI on June 27, 2018. DTSC confirms that the OU-E Lowland Terrestrial AOC and Riparian AOI soil are approved for NFA.

Other OU-E AOIs previously approved for NFA for soil include Pond 8 Fill Area AOI, West of Interim Remedial Measure (IRM) AOI, and IRM AOI. DTSC approved NFA for Pond 8 Fill Area AOI on February 7, 2013 with the approval of the OU-E Remedial Investigation Report. DTSC approved NFA for West of IRM AOI and IRM AOI on April 12, 2011 with the approval of the Operable Units C and D Remedial Investigation Report.

NFA soil and sediment areas are shown on Figure 1-5 of the draft OU-E RAP. I hope this letter clarifies areas of OU-E approved for NFA by DTSC.

If you have any questions regarding this letter, please contact Tom Lanphar at [Tom.Lanphar@dtsc.ca.gov](mailto:Tom.Lanphar@dtsc.ca.gov).

Sincerely,



Julie Pettijohn, Branch Chief  
Site Mitigation and Restoration Program – Berkeley Office

cc: continued next page

Dave Massengill  
December 8, 2020  
Page 3 of 3

cc (via email)  
Mr. Jeremie Maehr, P.E.  
Kennedy/Jenks Consultants  
[JeremieMaehr@kennedyjenks.com](mailto:JeremieMaehr@kennedyjenks.com)

Mr. Craig Hunt  
North Coast Regional Water Quality Control Board  
[Craig.Hunt@waterboards.ca.gov](mailto:Craig.Hunt@waterboards.ca.gov)

Ms. Tabatha Miller  
Fort Bragg Community Redevelopment Department  
[TMiller@fortbragg.com](mailto:TMiller@fortbragg.com)

Tom Lanphar  
Site Mitigation and Restoration Program – Berkeley Office  
Department of Toxic Substances Control  
[Tom.Lanphar@dtsc.ca.gov](mailto:Tom.Lanphar@dtsc.ca.gov)